



Chipsmall Limited consists of a professional team with an average of over 10 year of expertise in the distribution of electronic components. Based in Hongkong, we have already established firm and mutual-benefit business relationships with customers from,Europe,America and south Asia,supplying obsolete and hard-to-find components to meet their specific needs.

With the principle of "Quality Parts,Customers Priority,Honest Operation,and Considerate Service",our business mainly focus on the distribution of electronic components. Line cards we deal with include Microchip,ALPS,ROHM,Xilinx,Pulse,ON,Everlight and Freescale. Main products comprise IC,Modules,Potentiometer,IC Socket,Relay,Connector.Our parts cover such applications as commercial,industrial, and automotives areas.

We are looking forward to setting up business relationship with you and hope to provide you with the best service and solution. Let us make a better world for our industry!



## Contact us

Tel: +86-755-8981 8866 Fax: +86-755-8427 6832

Email & Skype: info@chipsmall.com Web: www.chipsmall.com

Address: A1208, Overseas Decoration Building, #122 Zhenhua RD., Futian, Shenzhen, China



## LED Driver

# Indoor 75 W Dimmable SI-EPF006450WW



## SELV Constant Current LED Driver Wide Operating Range up to 2.1 A – Dimmable

### Features & Benefits

- Output Current Range: 1.0 ~ 2.1 A (adjustable via LEDset)
- Output Voltage Range: 20 ~ 54 Vdc (SELV equivalent)
- Output Power Range: 32 ~ 80 W
- Dimming Control: DALI, smart dimming down to 1 %
- Input Voltage: 220 ~ 240 V
- Protections: Overload, No Load, Short Circuit, Over Temperature, Over Voltage, Load Hot Plug
- $t_a$  Range: -25 ~ +45 °C
- Expected Lifetime: 100,000 hours at  $t_c = 70$  °C
- Long lasting & high reliability
- Slim white metal housing
- Double output connectors (parallel connection)
- Very low output current ripple

### Applications

- Ambient Lighting (Linear and Area) and other Indoor Lighting Applications
- Office – Industry – Shop
- Suitable for emergency lighting units



## Table of Contents

1.	Characteristics	-----	3
2.	Typical Characteristics Graphs	-----	5
3.	Protection	-----	6
4.	Outline Drawing & Dimension	-----	7
5.	Label Structure	-----	8
6.	Packing Structure	-----	8
7.	Precautions in Handling & Use	-----	9

## 1. Characteristics

Article	Symbol	Specification			Unit	Note
		Min.	Typ.	Max.		
<b>INPUT SPECIFICATIONS</b>						
Nominal Voltage	V <sub>in</sub>	220 ~ 240			V <sub>ac</sub>	
Nominal Frequency	f <sub>in</sub>	0 / 50 / 60			Hz	Incl. DC or pulse DC
AC Voltage Range		198		264	V <sub>ac</sub>	
DC Voltage Range		176		276	V	DC or pulse DC
Maximum Voltage				350	V <sub>ac</sub>	1 hour max. (unit might not operate in this abnormal condition)
Nominal Current	I <sub>in</sub>	410			mA	
Total Harmonic Distortion	THD				20	% At full load, 220-240 V, 50 Hz (see graph)
Power Factor	PF	0.95				- At full load, 220-240 V, 50 Hz (see graph)
Efficiency	η	90				% At full load, 220-240 V, 50 Hz (see graph)
Power Losses					9	W At full load
No-load Power		n/a				W Load switching on output side is safe but not permitted
Stand-by Power					0.5	W
Protection Class		I			-	PE can be connected to either terminal or housing
In-rush Current					53	A <sub>pk</sub> t <sub>width</sub> = 200 μs typ. (at 50% I <sub>peak</sub> )
Units per Circuit Breaker					B16: 13 B10: 8	- I <sub>max</sub> = 53 A, t <sub>width</sub> = 200 μs
Leakage Current					0.5	mA Through PE, output floating
<b>OUTPUT SPECIFICATIONS</b>						
Nominal Voltage	V <sub>o</sub>	20 ~ 54			V <sub>dc</sub>	With load
Max. Voltage					60	V <sub>dc</sub> Open circuit, No-load protection, restart trials every 2-3 s
Nominal Current	I <sub>o</sub>	1.0 ~ 2.1			A	LEDset open: 0.5 A LEDset short: 2.1 A ±5 % through LEDset interface
Current Ripple					200	mA <sub>pk</sub> High frequency ripple (peak); Low frequency ripple is negligible
Nominal Power	P <sub>o</sub>	32 ~ 80			80	W Dimmable down to 0.2 W
Galvanic Isolation		SELV-equivalent				Output and LEDset to mains – Touch current < 0.7 mA
Touch Current					0.7	mA According to EN 60598-1 annex G and EN 61347-1 annex A
Switchover Time					0.5	s Both AC and DC mains

Article	Symbol	Specification			Unit	Note
		Min.	Typ.	Max.		
<b>DIMMING SPECIFICATIONS</b>						
Dimming Control			DALI			
Dimming Range			1 – 100		%	Of selected nominal current
Dimming Technique			Mixed			1-30 % PWM, 30-70 % Amplitude
Frequency		450			Hz	1-30 %
Galvanic Isolation			Basic / Double			Basic: DALI to primary-earth Double: DALI to secondary
<b>ENVIRONMENTAL SPECIFICATIONS</b>						
Ambient Temperature	$t_a$	-25		45	°C	
Case Temperature	$t_c$			80	°C	Measured at $t_c$ point as indicated on the product label
Case Temperature in fault condition				120	°C	
Storage Temperature	$t_s$	-25		85	°C	Cool down before operating
Relative Humidity		5		85	%	Not condensing
Surge Transient Protection	L / N			±1	kV	According to EN 61547-5.7
	LN / PE			±2	kV	
IP Rating			IP20		-	Suitable for indoor environment
Mains Switching cycles		100,000			-	
Expected Lifetime		50,000			h	$t_c = 80\text{ °C}$ , 0.2 % / 1000 h failure rate (14 h on / 10 h standby per day)
		100,000			h	$t_c = 70\text{ °C}$ , 0.1 % / 1000 h failure rate (14 h on / 10 h standby per day)
Dimensions	L x W x H		360 x 30 x 21		mm	

**Notes:**

- Standards: EN 61347-1, EN 61347-2-13, EN 55015, EN 61547, EN 61000-3-2, EN 62384, EN 62386
- This LED Power Supply is suitable for emergency lighting fixtures according to EN 60598-2-22; EOF<sub>1</sub> = 1% - 100% according to EN 61347-2-13. Continuous output power at  $t_a = 80\text{ °C}$  up to 30 W.

## 2. Typical Characteristics Graphs

a) Operating Window

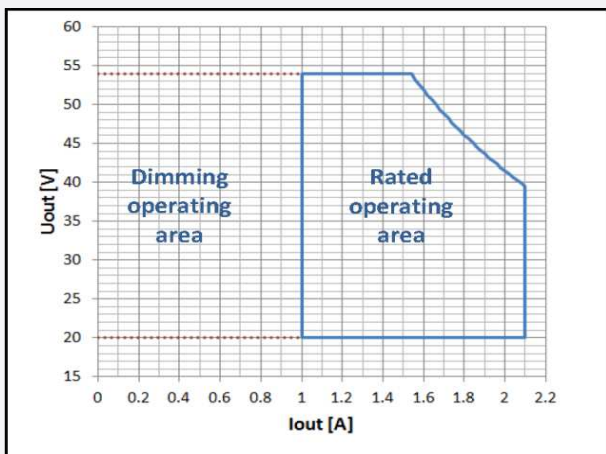

b) Efficiency vs. Load

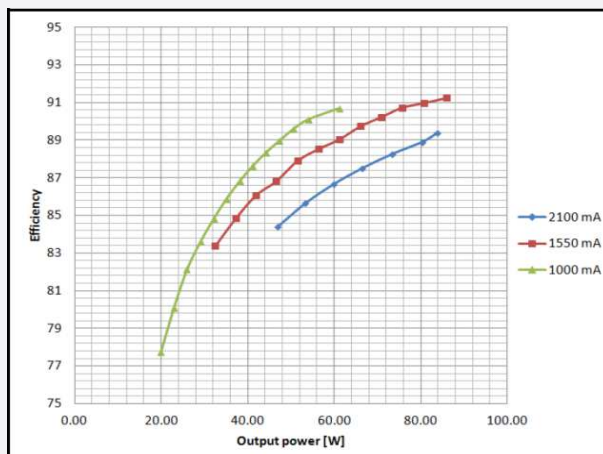

c) Power Factor vs. Load

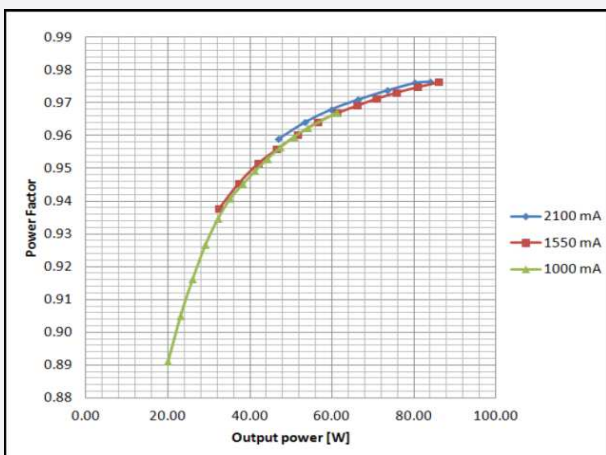

d) Total Harmonic Distortion vs. Load

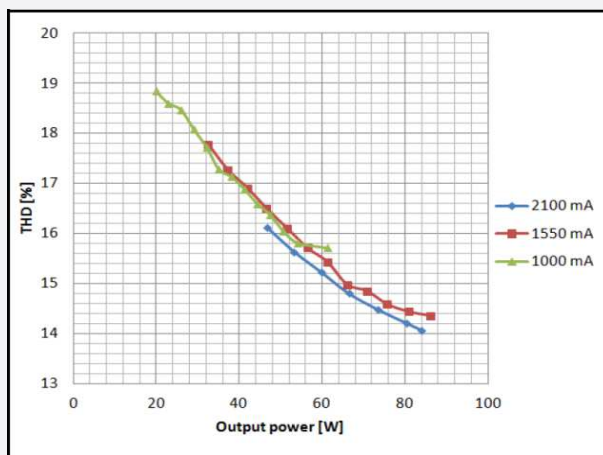

e) Output Current vs. Rset

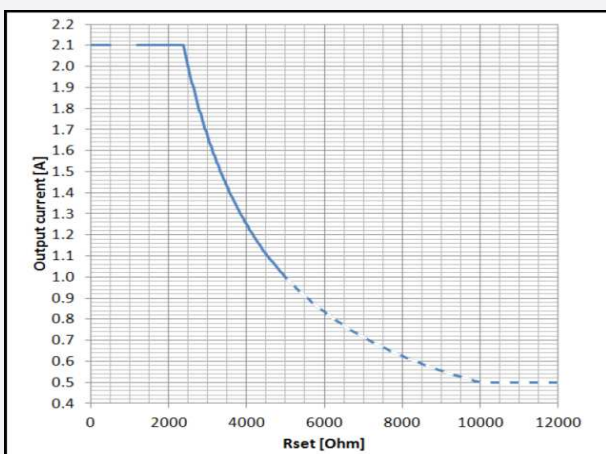

Rset Formula and Standard Current Values

$$I_{OUT[A]} = \frac{5V}{R_{set[\Omega]}} \times 1000$$

I <sub>out</sub> [mA] nominal	I <sub>out</sub> [mA] set, +/-5%	R <sub>set</sub> [kOhm] E48 series
1050	1064	4.7 (E24)
	1027	4.87 (E48)
1400	1389	3.6 (E24)
	1437	3.48 (E48)
1600	1667	3.0 (E24)
	1661	3.01 (E48)
2100	2100	2.2 (E24)
	2100	2.37 (E48)

### 3. Protection

- **Input over voltage protection**

Mains up to 350 Vac, for one hour maximum, will not destroy both the unit and the load; shut down of load might occur in this condition.

- **Output short circuit / under voltage protection**

Shut down of load happens if output voltage is below 20 V (typ. 18 V); the unit automatically tries to switch on the load again every 2-3 s for 0.1 s delivering the selected nominal current.

- **Output overload protection**

The unit automatically reduces the output current to keep the output power below 80 W.

- **Output over voltage protection**

Shut down of load happens if output voltage exceeds 54 V (typ. 55 V); the unit automatically tries to switch on the load again every 2-3 s for 0.1 s delivering the selected nominal current.

- **No load operation**

The unit automatically tries to switch on the load every 2-3 s for 0.1 s delivering the selected nominal current; despite this operation mode is safe for both unit and load, it is not recommended. Do not put a switch between load and unit.

- **Over temperature protection**

The unit is protected against temporary overheating by automatic reduction of the output current when  $80\text{ }^{\circ}\text{C} < t_c < 95\text{ }^{\circ}\text{C}$  typ., and by automatic power off if  $95\text{ }^{\circ}\text{C} < t_c < 100\text{ }^{\circ}\text{C}$  typ. The protection is self restoring.

- **Load hot plug protection**

Connection of LED load on secondary side is allowed without damage to the LED; LED will turn on automatically.

## 4. Outline Drawing & Dimension

### a) Dimension (mm)

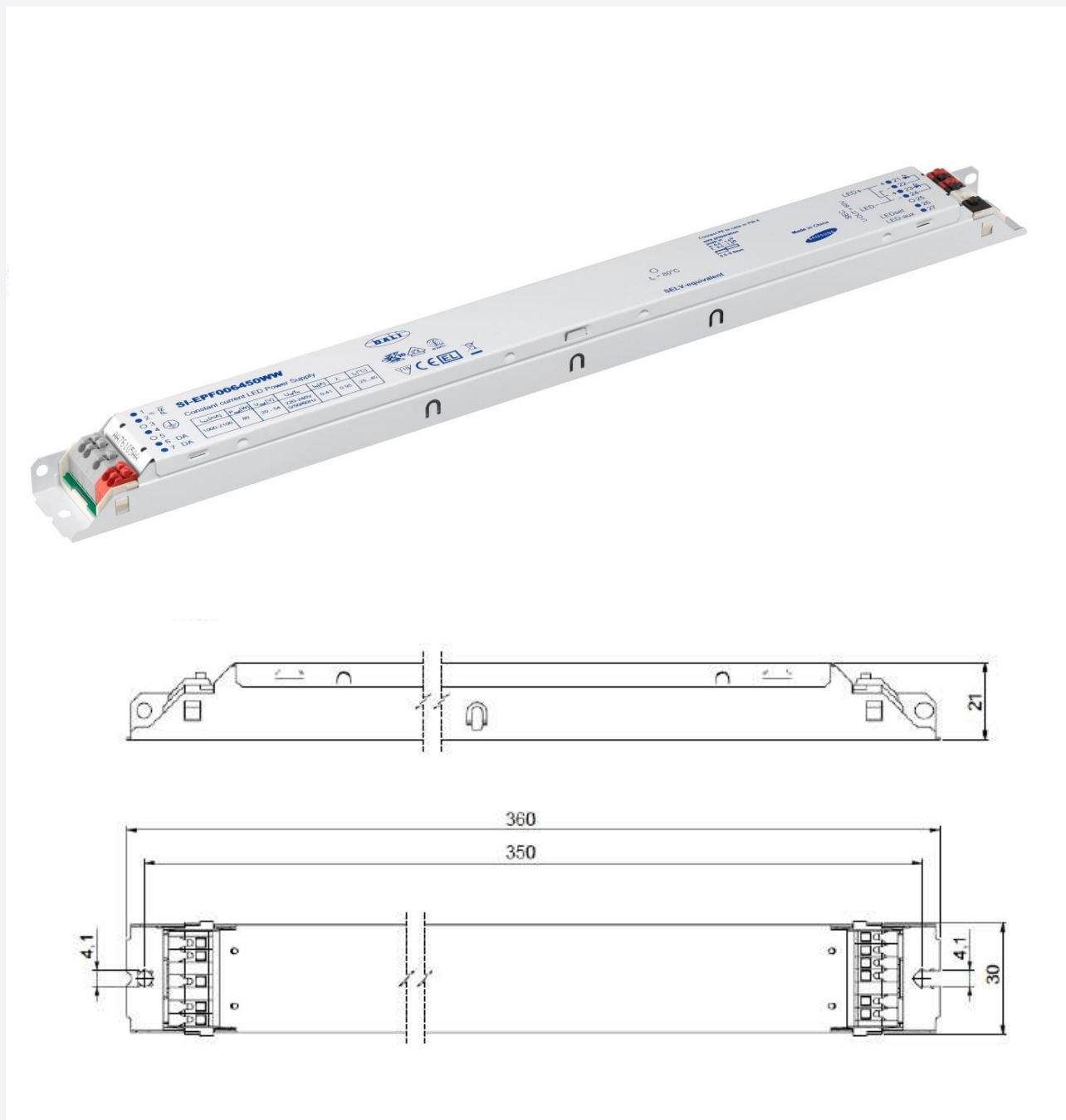

Housing material: metal, white painted



## b) Wiring Diagram

### Input

Gray 1 – Mains  
 Gray 2 – Mains  
 Gray 3 – n/a  
 Gray 4 – PE  
 White 5 – n/a  
 White 6 – DALI  
 White 7 – DALI

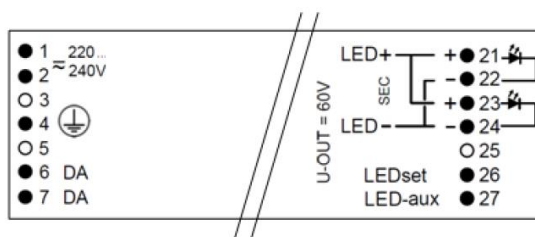

### Output

Red 21 – LED +  
 Black 22 – LED -  
 Red 23 – LED +  
 Black 24 – LED -  
 White 25 – n/a  
 White 26 – LEDset  
 Black 27 – LEDset-aux

**21 & 23 internally connected**  
**22 & 24 internally connected**

Connectors type (input and output): Wago 250  
 Wire cross-section: solid and flexible: 0.5 - 1.5 mm<sup>2</sup>  
 Wire peeling length: 8.5 - 9.5 mm  
 Load wire length: Max. 2 m

Two or more units cannot be connected together on secondary side (terminals 21 .. 27)

## 5. Label Structure

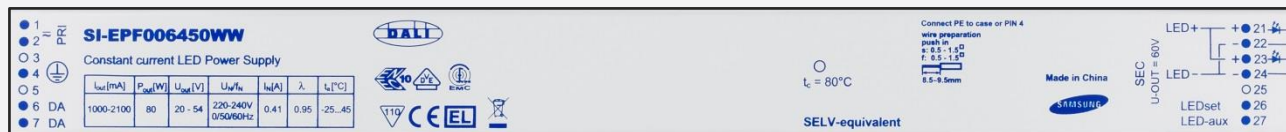

## 6. Packing Structure

Packing material

Max. quantity (pcs)

Outer Box

20

## 7. Precautions in Handling & Use

- 1) To prevent the LED Driver from any defect, please handle and store it with care
  - Do not drop or give shock
  - Do not store in very humid location or at extreme temperature
  - Do not open or disassemble the product
- 2) Static electricity or surge voltage may damage the components inside LED Driver, as such please observe proper anti-electrostatic working process
  - People handling the Driver should be well grounded (e.g. using ESD wrist band) and wear anti-static working clothes and gloves
  - All related devices and instruments in the production line should be well grounded (e.g. working table, measuring equipment, assembly jigs)
- 3) Observe the correct polarity of output terminal
- 4) Avoid input voltage exceeds the maximum rating, which will cause damage to the circuit and result in malfunction

# Legal and additional information.

## [About Samsung Electronics Co., Ltd.](#)

Samsung Electronics Co., Ltd. is a global leader in technology, opening new possibilities for people everywhere. Through relentless innovation and discovery, we are transforming the worlds of TVs, smartphones, tablets, PCs, cameras, home appliances, printers, LTE systems, medical devices, semiconductors and LED solutions. We employ 286,000 people across 80 countries with annual sales of US\$216.7 billion. To discover more, please visit [www.samsungled.com](http://www.samsungled.com).

Copyright © 2014 Samsung Electronics Co., Ltd. All rights reserved.  
Samsung is a registered trademark of Samsung Electronics Co., Ltd.  
Specifications and designs are subject to change without notice. Non-metric weights and measurements are approximate. All data were deemed correct at time of creation. Samsung is not liable for errors or omissions. All brand, product, service names and logos are trademarks and/or registered trademarks of their respective owners and are hereby recognized and acknowledged.

Samsung Electronics Co., Ltd.  
95, Samsung 2-ro  
Giheung-gu  
Yongin-si, Gyeonggi-do, 446-711  
KOREA

[www.samsungled.com](http://www.samsungled.com)

