



Chipsmall Limited consists of a professional team with an average of over 10 year of expertise in the distribution of electronic components. Based in Hongkong, we have already established firm and mutual-benefit business relationships with customers from,Europe,America and south Asia,supplying obsolete and hard-to-find components to meet their specific needs.

With the principle of "Quality Parts,Customers Priority,Honest Operation,and Considerate Service",our business mainly focus on the distribution of electronic components. Line cards we deal with include Microchip,ALPS,ROHM,Xilinx,Pulse,ON,Everlight and Freescale. Main products comprise IC,Modules,Potentiometer,IC Socket,Relay,Connector.Our parts cover such applications as commercial,industrial, and automotives areas.

We are looking forward to setting up business relationship with you and hope to provide you with the best service and solution. Let us make a better world for our industry!



Contact us

Tel: +86-755-8981 8866 Fax: +86-755-8427 6832

Email & Skype: info@chipsmall.com Web: www.chipsmall.com

Address: A1208, Overseas Decoration Building, #122 Zhenhua RD., Futian, Shenzhen, China



OPTICAL PROXIMITY DETECTOR

Features

- High-performance proximity detector with a sensing range of up to 50 cm
- Single-pulse sensing mode for low system power
- Adjustable detection threshold and strobe frequency
- Proximity (PRX) status latch enables controlling devices to avoid missing a detection
- High EMI immunity without shielded packaging
- 2 to 5.25 V power supply
- Operating temperature range: -40 to +85 °C
- Typical 10 µA current consumption and ultra-low power of 1 mA typical
- Current driven (400 mA) or saturated LED driver output
- Small outline: 3x3 mm (ODFN)

Applications

- Proximity sensing
- Photo-interrupter
- Occupancy sensing
- Touchless switch
- Object detection
- Handsets
- Intrusion/tamper detection

Description

The Si1102 is a high-performance (0–50 cm) active proximity detector. Because it operates on an absolute reflectance threshold principle, it avoids the ambiguity of motion-based proximity systems.

The Si1102 consists of a patented, high-EMI immunity, differential photodiode and a signal-processing IC with LED driver and high-gain optical receiver. Proximity detection is based on measurements of reflected light from a strobed, optically-isolated LED. The standard package for the Si1102 is an 8-pin ODFN.

Functional Block Diagram

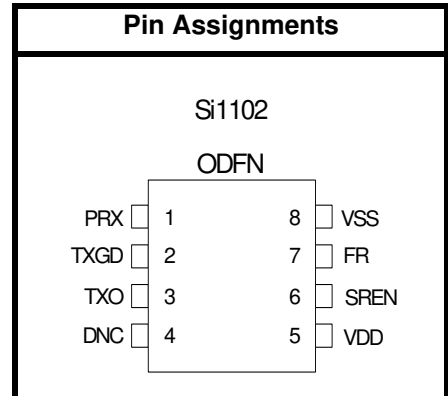
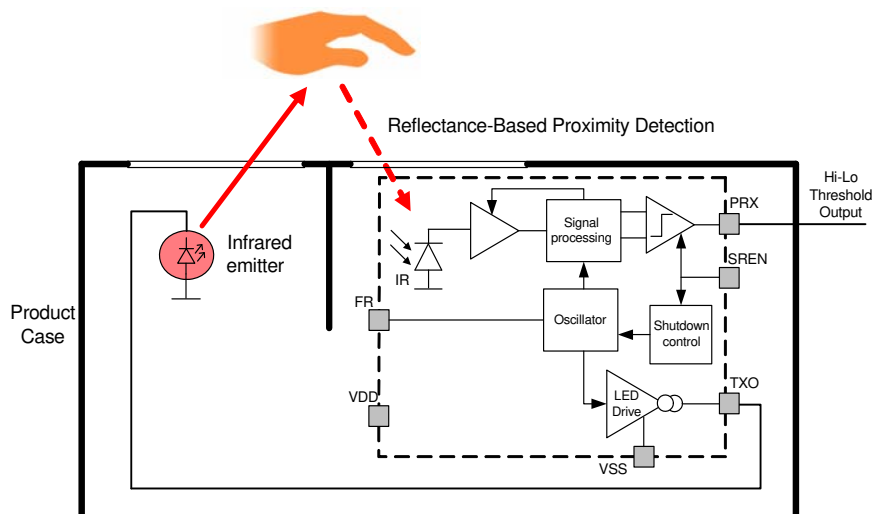

U.S. Patent 5,864,591

U.S. Patent 6,198,118

U.S. Patent 7,486,386

Other patents pending

TABLE OF CONTENTS

<u>Section</u>	<u>Page</u>
1. Electrical Specifications	4
2. Typical Application Schematic	6
3. Application Information	7
3.1. Theory of Operation	7
3.2. Choice of LED and LED Current	8
3.3. Power-Supply Transients	8
3.4. Mechanical and Optical Implementation	8
3.5. Typical Characteristics	10
4. Pin Descriptions—Si1102	12
5. Ordering Guide	13
6. Photodiode Center	13
7. Package Outline (8-Pin ODFN)	14
Document Change List	15
Contact Information	16

1. Electrical Specifications

Table 1. Absolute Maximum Ratings

Parameter	Conditions	Min	Typ	Max	Units
Supply Voltage		-0.3	—	5.5	V
Operating Temperature		-55	—	85	°C
Storage Temperature		-65	—	85	°C
Voltage on TXO with respect to GND		-0.3	—	5.5	V
Voltage on all other Pins with respect to GND		-0.3	—	VDD + 0.3	V
Maximum total current through TXO (TXO Active)		—	—	500	mA
Maximum Total Current through TXGD and VSS		—	—	600	mA
Maximum Total Current through all other Pins		—	—	100	mA
ESD Rating	Human body model	—	—	2	kV

Table 2. Recommended Operating Conditions

Parameter	Symbol	Conditions/Notes	Min	Typ	Max	Units
Supply Voltage	V _{DD}	-40 to +85 °C, V _{DD} to VSS	2.2	3.3	5.25	V
Operating Temperature			-40	25	85	°C
SREN High Threshold	V _{IH}		VDD - 0.6	—	—	V
SREN Low Threshold	V _{IL}		—	—	0.6	V
Active TXO Voltage ¹			—	—	1.0	V
Peak-to-Peak Power Supply Noise Rejection		V _{DD} = 3.3 V, 1 kHz–10 MHz no spurious PRX or less than 20% reduction in range	—	—	50	mVPP on V _{DD}
DC Ambient light	E _{dc}	V _{DD} = 3.3 V	—	1	100	klux
LED Emission Wavelength ²			600	850	950	nm
Notes:						
1. Minimum R1 resistance should be calculated based on LED forward voltage, maximum LED current, LED voltage rail used, and maximum active TXO voltage.						
2. When using LEDs near the min and max wavelength limits, higher radiant intensities may be needed to achieve the system's proximity sensing performance goals.						

Table 3. Electrical Characteristics

Parameter	Symbol	Conditions/Notes	Min	Typ	Max	Units
PRX Logic High Level	VOH	$V_{DD} = 3.3 \text{ V}$, $I_{prx} = 4 \text{ mA}$	$V_{DD} - 0.6$	—	—	V
PRX Logic Low Level	VOL	$V_{DD} = 3.3 \text{ V}$, $I_{prx} = -4 \text{ mA}$	—	—	0.6	V
I_{DD} Shutdown	I_{DD}	$SREN = V_{DD}$, $FR = 0$, $V_{DD} = 3.3 \text{ V}$	—	0.1	1.0	μA
I_{DD} Average Current		$SREN = 0 \text{ V}$, $V_{DD} = 3.3 \text{ V}$, $FR = 0$	30	120	200	μA
I_{DD} Average Current		$SREN = 0 \text{ V}$, $V_{DD} = 3.3 \text{ V}$, $FR = \text{open}$	—	5	20	μA
I_{DD} Current during Transmit, Saturated Driver		$V_{DD} = 3.3 \text{ V}$, $LED I = 100 \text{ mA}$	—	8	—	mA
I_{DD} Current during Transmit, Not Saturated		$V_{DD} = 3.3 \text{ V}$, $LED I = 400 \text{ mA}$	5	14	30	mA
Sample Strobe Rate ¹	FR	$V_{DD} = 3.3 \text{ V}$, $R2 = 0 \Omega$	100	250	600	Hz
Sample Strobe Rate ¹	FR	$V_{DD} = 3.3 \text{ V}$, $R2 = 100 \text{ k}\Omega$	—	7	30	Hz
Sample Strobe Rate ¹	FR	$V_{DD} = 3.3 \text{ V}$, $R2 = (\text{open})$	—	2	8	Hz
Min. Detectable Reflectance Input	E _{min}	$V_{DD} = 3.3 \text{ V}$, 850 nm source	—	1	—	$\mu\text{W}/\text{cm}^2$
SREN Low to TXO Active	T _{den}	$V_{DD} = 3.3 \text{ V}$	200	500	1000	μs
TXO Leakage Current	I _{txo_sd}	$V_{DD} = 3.3 \text{ V}$, no strobe	—	0.01	1	μA
TXO Current ²	I _{txo1V}	$V_{TXO} = 1 \text{ V}$, $V_{DD} = 3.3 \text{ V}$	100	380	600	mA
TXO Saturation Voltage	V _{sat}	$I_{TXO} = I_{TXO1V} \times 80\%$	—	0.5	0.7	V
Notes:						
1. Max column also applies to $V_{DD} > 3.6 \text{ V}$. See Figure 6.						
2. When operating at $V_{DD} = 2.0 \text{ V}$, the typical TXO current is 250 mA.						

2. Typical Application Schematic

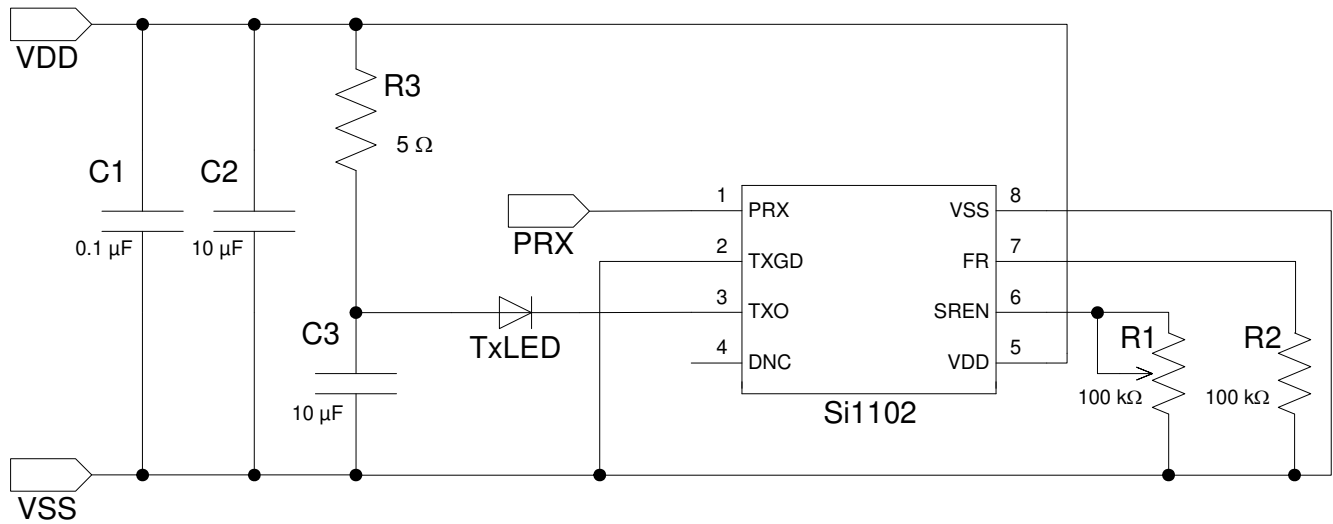

Note: R1 resistance should be factory-adjustable to achieve a consistent proximity object detection threshold across different combinations of irLED, product window, and sensor sensitivity.

Figure 1. Application Example of the Proximity Sensor Using a Single Supply

3. Application Information

3.1. Theory of Operation

The Si1102 is an active optical reflectance proximity detector with a simple on/off digital output whose state is based upon the comparison of reflected light against a set threshold. An LED sends light pulses whose reflections reach a photodiode and are processed by the Si1102's analog circuitry. If the reflected light is above the detection threshold, the Si1102 asserts the active-low PRX output to indicate proximity. This output can be used as a control signal to activate other devices or as an interrupt signal for microcontrollers. Note that when the proximity of an object nears the pre-set threshold, it is normal for the PRX pin to alternate between the on and off states. The microcontroller can take the time average of PRX (assigning 1 as "no detect" and 0 as "detect") and then compare the average to 0.5 to achieve a sharper in-proximity or out-of-proximity decision.

To achieve maximum performance, high optical isolation is required between two light ports, one for the transmit LED and the other for the Si1102. The Si1102 light port should be infrared-transmissive, blocking visible light wavelengths for best performance. This dual-port active reflection proximity detector has significant advantages over single-port, motion-based infrared systems, which are good only for triggered events. Motion detection only identifies proximate moving objects and is ambiguous about stationary objects. The Si1102 allows in- or out-of-proximity detection, reliably determining if an object has left the proximity field or is still in the field even when not moving.

An example of a proximity detection application is controlling the display and speaker of a cellular telephone. In this type of application, the cell phone turns off the power-consuming display and disables the loudspeaker when the device is next to the ear, then reenables the display (and, optionally, the loudspeaker) when the phone moves more than a few inches away from the ear.

For small objects, the drop in reflectance is as much as the fourth power of the distance; this means that there is less range ambiguity than with passive motion-based devices. For example, a sixteen-fold change in an object's reflectance means only a fifty-percent drop in detection range.

The Si1102 proximity detector is designed to operate with a minimal number of external components. Figure 1 shows a circuit example using a single 3.3 V power supply. The potentiometer, R1, is used to set the proximity detection threshold. The Si1102 periodically detects proximity at a rate that can be programmed by a single resistor (R2). The part is powered down between measurements. The resulting average current, including that of the LED, can be as low as a few microamperes, which is well below a typical lithium battery's self-discharge current of 10 μ A, thus ensuring the battery's typical life of 10 years.

When enabled (SREN driven low by a microcontroller or R1 pull-down potentiometer exists), the Si1102 powers up, then pulses the output of the LED driver. Light reflected from a proximate object is detected by the receiver, and, if it exceeds a threshold set by the potentiometer at the SREN pin, the proximity status is latched to the active-low PRX output pin. The output is updated once per cycle. The cycle time is controlled through the optional R2 resistor.

Although the thresholds are normally set using a potentiometer for R1 (or R2), it is possible to digitally control various resistance values by using MCU GPIO pins to switch-in different value resistors (or parallel combinations of resistors). To activate the chosen resistor(s), the GPIO pin is held low, creating a pull-down resistor. For the unwanted resistors, those specific MCU pins are kept tri-stated, rendering those resistors floating.

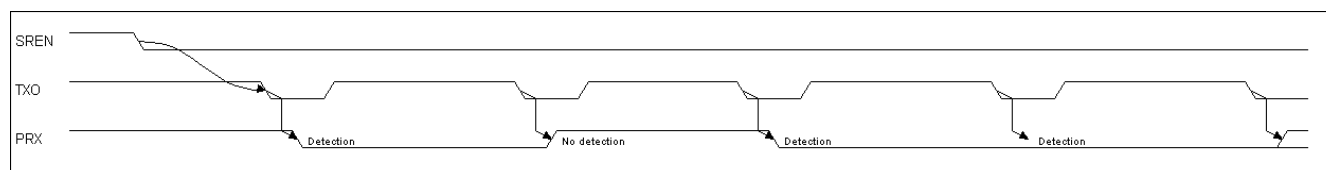

Figure 2. Timing Diagram

3.2. Choice of LED and LED Current

In order to maximize detection distance, the use of an infrared LED is recommended. However, red (visible) LEDs are viable in applications where a visible flashing LED may be useful and a shorter detection range is acceptable. White LEDs have slow response and do not match the Si1102's spectral response well; they are, therefore, not recommended.

To maximize proximity detection distance, an LED with a peak current handling of 400 mA is recommended. With careful system design, the duty cycle can be made low, enabling most LEDs to handle this peak current while keeping the LED's average current draw on the order of a few microamperes.

Another consideration when choosing an LED is the LED's half-angle. An LED with a narrow half-angle focuses the available infrared light using a narrower beam. When the concentrated infrared light encounters an object, the reflection is much brighter. Detection of human-size objects one meter away can be achieved when choosing an LED with a narrower half-angle and coupling it with an infrared filter on the enclosure.

3.3. Power-Supply Transients

Despite the Si1102's extreme sensitivity, it has good immunity from power-supply ripple, which should be kept below 50 mVpp for optimum performance. Power-supply transients (at the given amplitude, frequency, and phase) can cause either spurious detections or a reduction in sensitivity if they occur at any time within the 300 μ s prior to the LED being turned on. Supply transients occurring after the LED has been turned off have no effect since the proximity state is latched until the next cycle. The Si1102 itself produces sharp current transients on its VDD pin, and, for this reason, must also have a low-impedance capacitor on its supply pins. Current transients at the Si1102 supply can be up to 20 mA.

The typical LED current peak of 400 mA can induce supply transients well over 50 mVpp, but those transients are easy to decouple with a simple R-C filter because the duty-cycle-averaged LED current is quite low. The TXO output can be allowed to saturate without problem. Only the first 10 μ s of the LED turn-on time are critical to the detection range; this further lessens the need for large reservoir capacitors on the LED supply. In most applications, 10 μ F is adequate. If the LED is powered directly from a battery or limited-current source, it is desirable to minimize the load peak current by adding a resistor in series with the LED's supply capacitor.

If a regulated supply is available, the Si1102 should be connected to the regulator's output and the LED to the unregulated voltage, provided it is less than 7 V. There is no power-sequencing requirement between VDD and the LED supply.

3.4. Mechanical and Optical Implementation

It is important to have an optical barrier between the LED and the Si1102. The reflection from objects to be detected can be very weak since, for small objects within the LED's emission angle, the amplitude of the reflected signal decreases in proportion with the fourth power of the distance. The receiver can detect a signal with an irradiance of 1 μ W/cm². An efficient LED typically can drive to a radiant intensity of 100 mW/sr. Hypothetically, if this LED were to couple its light directly into the receiver, the receiver would be unable to detect any 1 μ W/cm² signal since the 100 mW/cm² leakage would saturate the receiver. Therefore, to detect the 1 μ W/cm² signal, the internal optical coupling (e.g. internal reflection) from the LED to the receiver must be minimized to the same order of magnitude (decrease by 10⁵) as the signal the receiver is attempting to detect. As it is also possible for some LEDs to drive a radiant intensity of 400 mW/sr, it is good practice to optically decouple the LED from the source by a factor of 10⁶.

If an existing enclosure is being reused and does not have dedicated openings for the LED and the Si1102, the proximity detector may still work if the optical loss factor through improvised windows (e.g. nearby microphone or fan holes) or semi-opaque material is not more than 90% in each direction. In addition, the internal reflection from an encased device's PMMA (acrylic glass) window (common in cellular telephones, PDAs, etc.) must be reduced through careful component placement. To reduce the optical coupling from the LED to the Si1102 receiver, the distance between the LED and the Si1102 should be maximized, and the distance between both components (LED and Si1102) to the PMMA window should be minimized. The detector can also work without a dedicated window if a semi-opaque plastic case is used.

For applications where R1 resistance values are small, the proximity range can vary as a function of the ambient IR condition. A product cover, which limits the visible light intensity, is helpful in reducing this range variation. It is recommended that the Si1102 be evaluated and tested in-product under the various light conditions it will encounter under normal product usage. Setting the potentiometer R1 = 0 is not recommended unless the ambient light condition is known and relatively constant.

At any given R1 threshold setting, there are many factors that determine the precise distance that the Si1102 reports. These factors include object reflectivity, object size, ambient light type and ambient light intensity. When used in applications where the ambient light is variable, it is recommended the Si1102 optical window be IR transmissive but visible light opaque.

Table 4. Summary of External Component Values and Operating Conditions

R1	R2	Strobe Frequency	Distance ¹	IDD Average Current Consumption ²
50 k Ω	0	250 Hz	12 to 22 cm	100 μ A
50 k Ω	Open	2.0 Hz	12 to 22 cm	5 μ A
15 k Ω	0	250 Hz	40 to 50 cm	100 μ A
30 k Ω	0	250 Hz	17 to 33 cm	100 μ A

Notes:

1. Distance measured with SFH4650 IR LED, with an IR filter, targeting an 18% gray card, 300 lux (Incandescent or CFL)
2. Average current consumption at VDD = 3.3 V, 25 °C and dark ambient conditions (<100 lx).

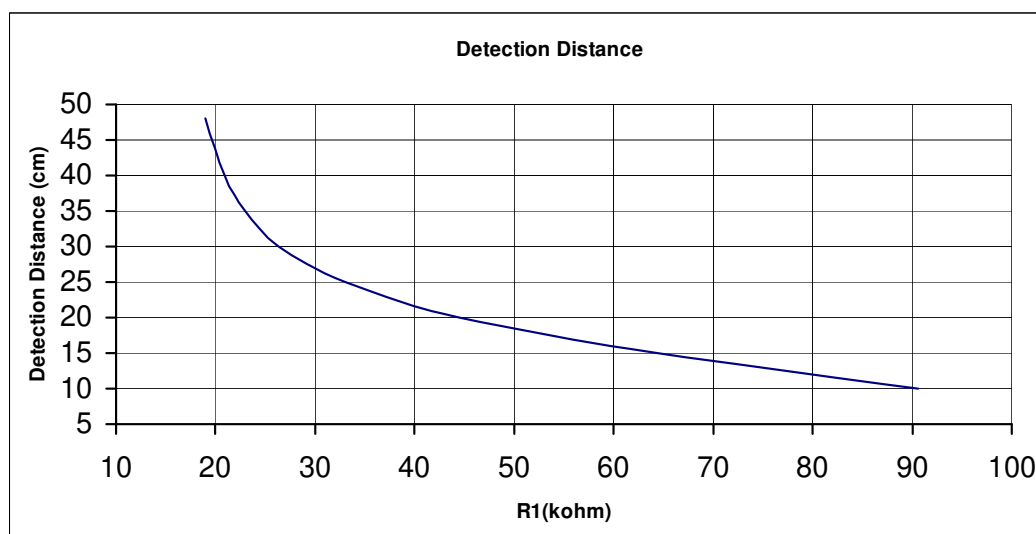

Figure 3. Proximity Detection Distance vs. R1 (SFH4650 IR LED 850 nm/40 mW)*

***Note:** Detection range measured using Kodak Gray cards (18% reflectance), no IR filter under dark ambient conditions (<1 lx).

3.5. Typical Characteristics

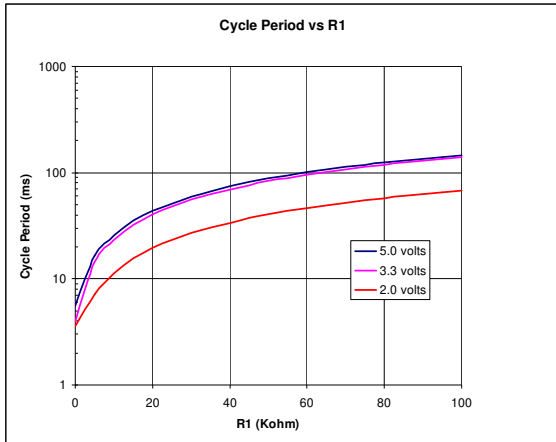

Figure 4. Cycle Period vs. R2
(R1 = 5.1 kΩ, Vtxo = 1 V)

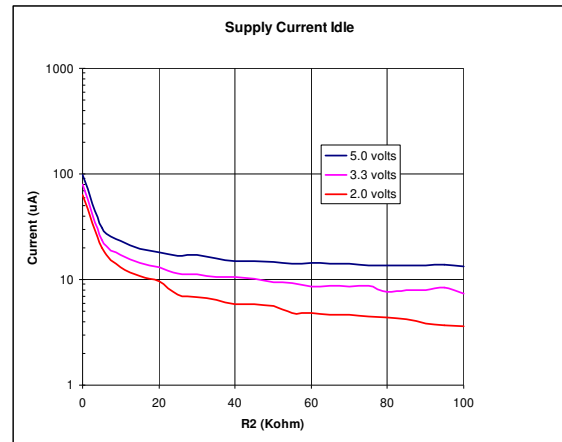

Figure 7. Idle Supply Current vs. R2
(R1 = 5.1 kΩ, Vtxo = 1 V)

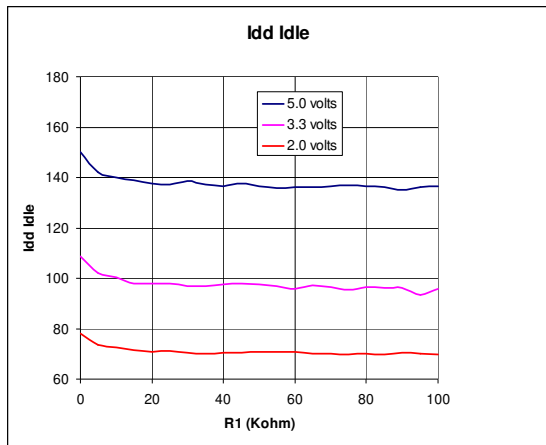

Figure 5. Idle Supply Current vs. R1
(R2 = 0 kΩ, Vtxo = 1 V)

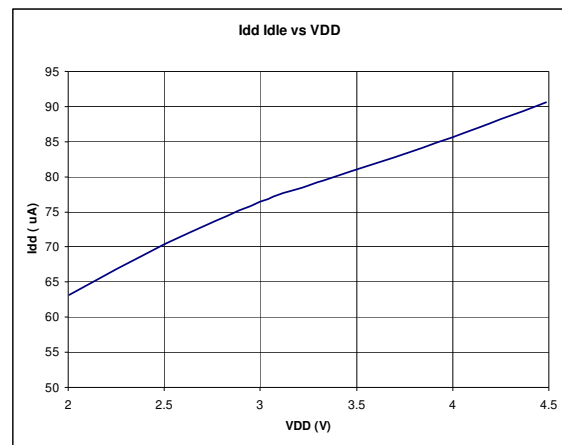

Figure 8. Idle Supply Current vs V_{DD}
(R1 = 5.1 kΩ, R2 = 0 Ω, Vtxo = 1 V)

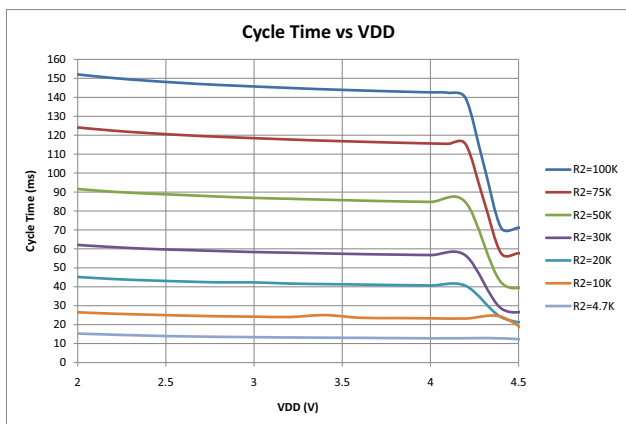

Figure 6. Cycle Period vs. V_{DD}
(R1 = 5.1 kΩ, Vtxo = 1 V)

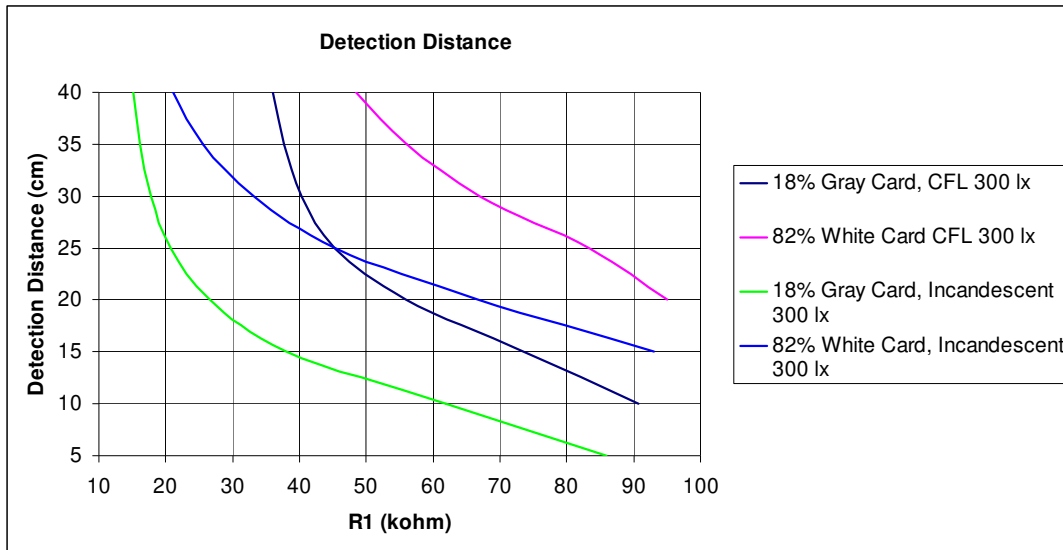

Figure 9. Proximity Detection Distance vs. Target Reflectivity (with IR Filter)

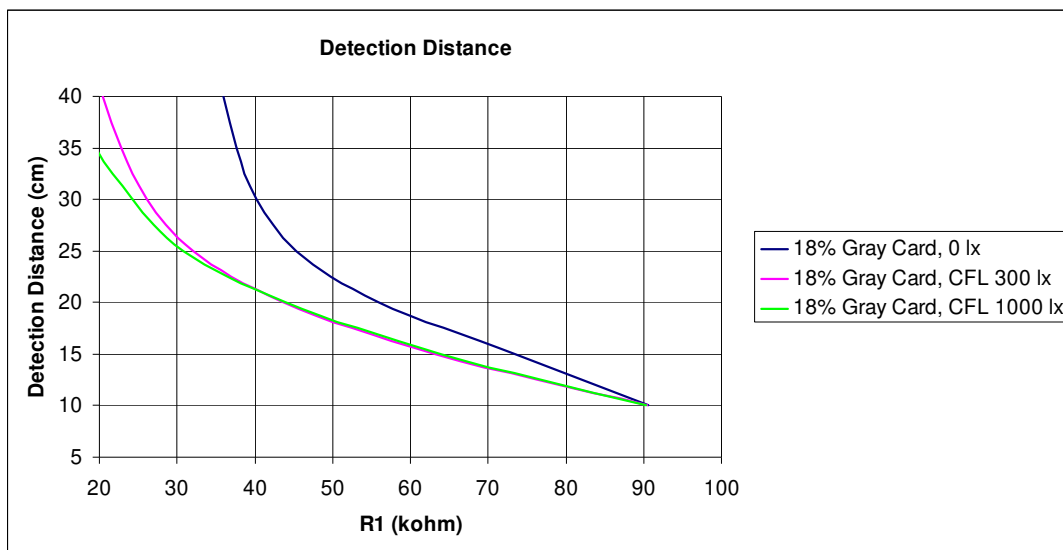

Figure 10. Proximity Detection Distance vs. Ambient Light (with IR Filter)

4. Pin Descriptions—Si1102

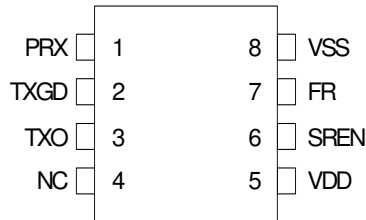

Figure 11. Pin Configuration

Table 5. Pin Descriptions

Pin	Name	Type	Description
1	PRX	Output	Proximity Output. Normally high; goes low when proximity is detected. When device is not enabled, the PRX pulls-up to V_{DD} .
2	TXGD	Ground	TXGD. Transmit ground (includes PRX return and other digital signals). Must be connected to VSS.
3	TXO	Output	Transmit Output Strobe. Normally connected to an infrared LED cathode. This output can be allowed to saturate, and output current can be limited by the addition of a resistor in series with the LED. It can also be connected to an independent unregulated LED supply even if the V_{DD} supply is at 0 V without either drawing current or causing latchup problems.
4	NC		Do not connect.
5	VDD	Input	Power Supply. 2 to 5.25 V voltage source
6	SREN	Input	Sensitivity Resistor/ENable. Driving SREN below 1 V or connecting resistance from SREN to VSS enables the chip and immediately starts a proximity measurement cycle. A potentiometer to VSS controls proximity sensitivity. $R1 = 0$ yields maximum detection distance. If SREN is high and FR is low ($SREN = V_{DD}$, $FR = 0$), part is in shutdown.
7	FR	Input	Frequency Resistor. A resistor to VSS controls the proximity-detection cycle frequency. With no resistor, the sample frequency is, at most, 5.0 Hz. With FR shorted to VSS the sample frequency is typically 250 Hz. With a 100 k Ω resistor, the sample frequency is typically 7 Hz, maximum 30 Hz. The voltage on FR relative to ground is only about 30 mV.
8	VSS	Ground	VSS. Ground (analog ground).

5. Ordering Guide

Part Ordering #	Temperature	Package
Si1102-A-GM	-40 to +85 °C	3x3 mm ODFN8

6. Photodiode Center

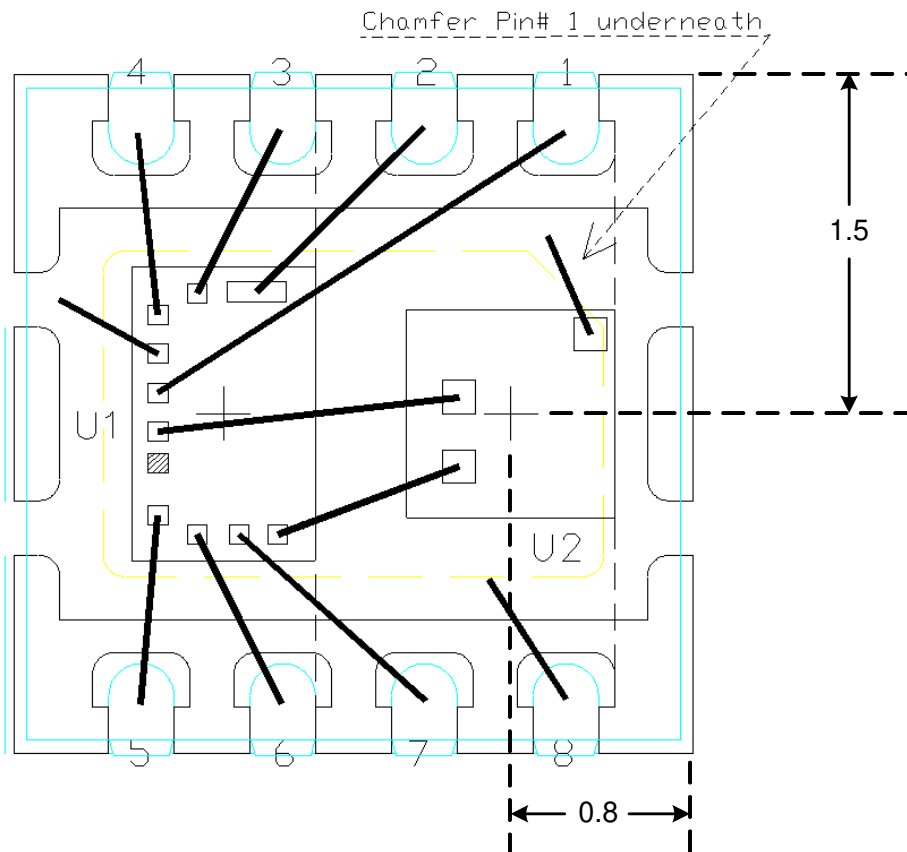

Figure 12. Photodiode Center

7. Package Outline (8-Pin ODFN)

Figure 13 illustrates the package details for the Si1102 ODFN package. Table 6 lists the values for the dimensions shown in the illustration.

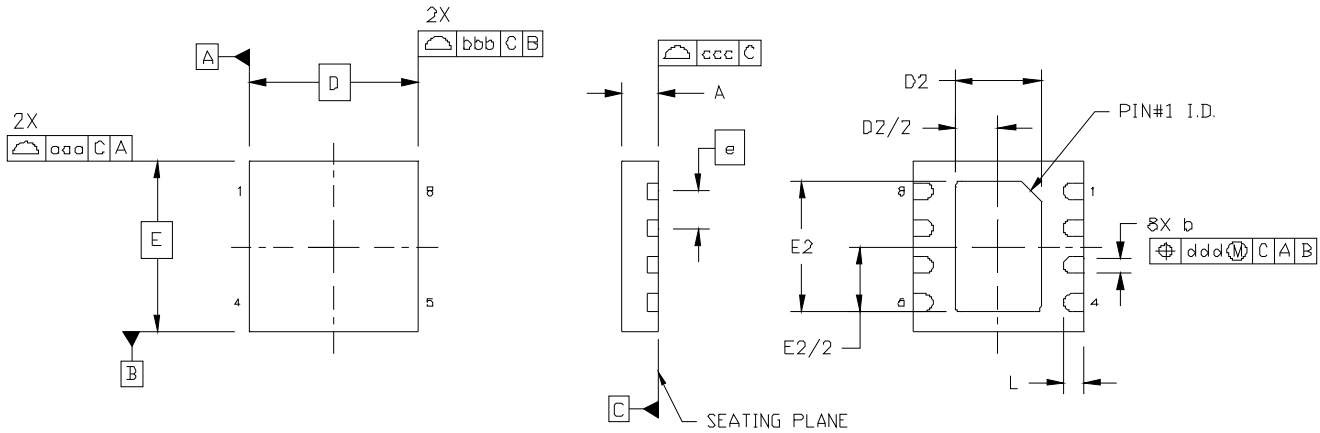

Figure 13. ODFN Package Diagram Dimensions

Table 6. Package Diagram Dimensions

Dimension	Min	Nom	Max
A	0.55	0.65	0.75
b	0.25	0.30	0.35
D	3.00 BSC.		
D2	1.40	1.50	1.60
e	0.65 BSC.		
E	3.00 BSC.		
E2	2.20	2.30	2.40
L	0.30	0.35	0.40
aaa	0.10		
bbb	0.10		
ccc	0.08		
ddd	0.10		
Notes:			
1. All dimensions shown are in millimeters (mm).			
2. Dimensioning and Tolerancing per ANSI Y14.5M-1994.			

DOCUMENT CHANGE LIST

Revision 0.6 to Revision 0.7

- Revised outline drawing for 3x3 ODFN.
 - Adjusted pin width to match true scale
 - Tightened tolerance on body dimensions

Revision 0.7 to Revision 0.8

- Updated Tables 1, 2, 3, 4, and 5.
- Updated Figures 1, 2, 3, 5, 11, and 12.

Revision 0.8 to Revision 1.0

- Updated Table 2, Table 3, and Table 5
- Updated Figure 1 and Figure 6.
- Updated Section 3.4 concerning usage of small R1 values.
- Added "6. Photodiode Center" on page 13.

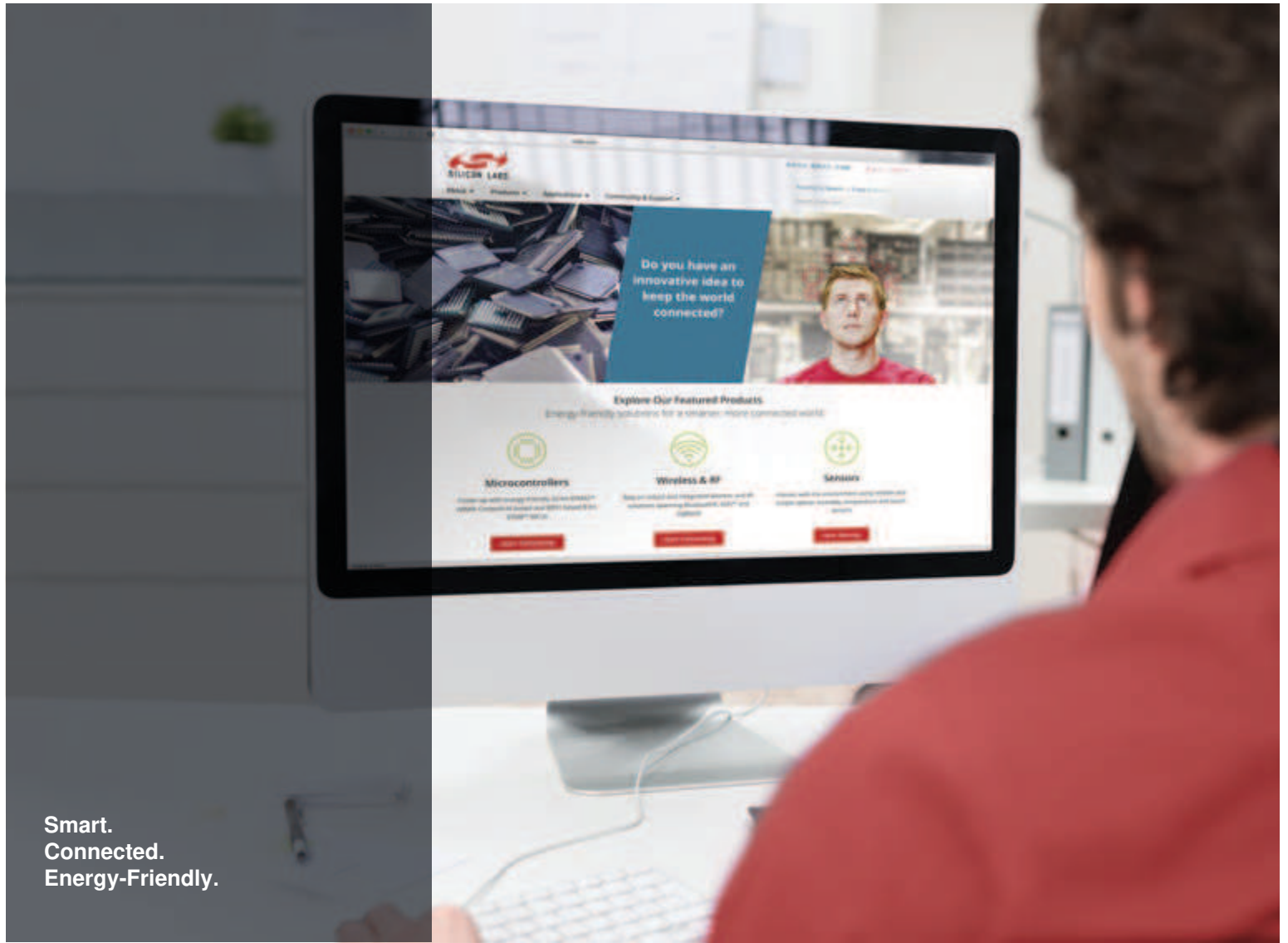

Smart.
Connected.
Energy-Friendly.



Products
www.silabs.com/products

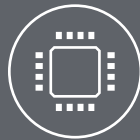

Quality
www.silabs.com/quality



Support and Community
community.silabs.com

Disclaimer

Silicon Laboratories intends to provide customers with the latest, accurate, and in-depth documentation of all peripherals and modules available for system and software implementers using or intending to use the Silicon Laboratories products. Characterization data, available modules and peripherals, memory sizes and memory addresses refer to each specific device, and "Typical" parameters provided can and do vary in different applications. Application examples described herein are for illustrative purposes only. Silicon Laboratories reserves the right to make changes without further notice and limitation to product information, specifications, and descriptions herein, and does not give warranties as to the accuracy or completeness of the included information. Silicon Laboratories shall have no liability for the consequences of use of the information supplied herein. This document does not imply or express copyright licenses granted hereunder to design or fabricate any integrated circuits. The products are not designed or authorized to be used within any Life Support System without the specific written consent of Silicon Laboratories. A "Life Support System" is any product or system intended to support or sustain life and/or health, which, if it fails, can be reasonably expected to result in significant personal injury or death. Silicon Laboratories products are not designed or authorized for military applications. Silicon Laboratories products shall under no circumstances be used in weapons of mass destruction including (but not limited to) nuclear, biological or chemical weapons, or missiles capable of delivering such weapons.

Trademark Information

Silicon Laboratories Inc.®, Silicon Laboratories®, Silicon Labs®, SiLabs® and the Silicon Labs logo®, Bluegiga®, Bluegiga Logo®, Clockbuilder®, CMEMS®, DSPLL®, EFM®, EFM32®, EFR®, Ember®, Energy Micro, Energy Micro logo and combinations thereof, "the world's most energy friendly microcontrollers™", Ember®, EZLink®, EZRadio®, EZRadioPRO®, Gecko®, ISOModem®, Precision32®, ProSLIC®, Simplicity Studio®, SiPHY®, Telegesis, the Telegesis Logo®, USBXpress® and others are trademarks or registered trademarks of Silicon Laboratories Inc. ARM, CORTEX, Cortex-M3 and THUMB are trademarks or registered trademarks of ARM Holdings. Keil is a registered trademark of ARM Limited. All other products or brand names mentioned herein are trademarks of their respective holders.



Silicon Laboratories Inc.
400 West Cesar Chavez
Austin, TX 78701
USA

<http://www.silabs.com>