



Chipsmall Limited consists of a professional team with an average of over 10 year of expertise in the distribution of electronic components. Based in Hongkong, we have already established firm and mutual-benefit business relationships with customers from,Europe,America and south Asia,supplying obsolete and hard-to-find components to meet their specific needs.

With the principle of “Quality Parts,Customers Priority,Honest Operation,and Considerate Service”,our business mainly focus on the distribution of electronic components. Line cards we deal with include Microchip,ALPS,ROHM,Xilinx,Pulse,ON,Everlight and Freescale. Main products comprise IC,Modules,Potentiometer,IC Socket,Relay,Connector.Our parts cover such applications as commercial,industrial, and automotives areas.

We are looking forward to setting up business relationship with you and hope to provide you with the best service and solution. Let us make a better world for our industry!



Contact us

Tel: +86-755-8981 8866 Fax: +86-755-8427 6832

Email & Skype: info@chipsmall.com Web: www.chipsmall.com

Address: A1208, Overseas Decoration Building, #122 Zhenhua RD., Futian, Shenzhen, China



Dual P-Channel 12 V (D-S) MOSFET

PRODUCT SUMMARY			
V_{DS} (V)	$R_{DS(on)}$ (Ω)	I_D (A)	Q_g (Typ.)
- 12	0.390 at $V_{GS} = - 4.5$ V	- 1.3 ^a	1.7 nC
	0.535 at $V_{GS} = - 2.5$ V	- 1.2	
	0.710 at $V_{GS} = - 1.8$ V	- 1.1	

FEATURES

- Halogen-free According to IEC 61249-2-21 Definition
- TrenchFET[®] Power MOSFET
- Compliant to RoHS Directive 2002/95/EC



RoHS
COMPLIANT
HALOGEN
FREE
Available

APPLICATIONS

- Load Switch for Portable Devices

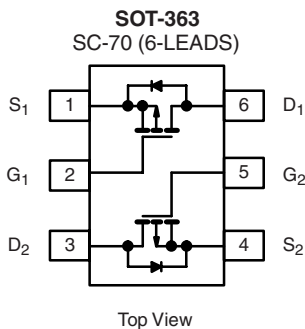

Marking Code

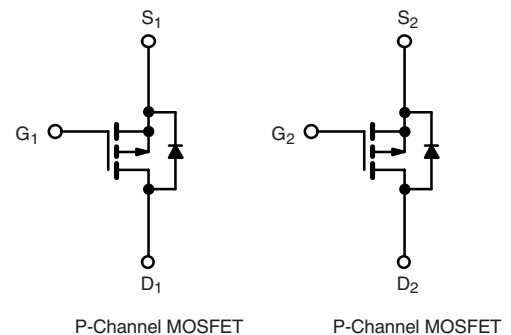
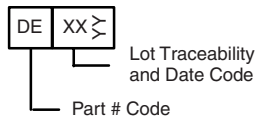

Ordering Information: Si1965DH-T1-E3 (Lead (Pb)-free)
Si1965DH-T1-GE3 (Lead (Pb)-free and Halogen-free)

ABSOLUTE MAXIMUM RATINGS $T_A = 25$ °C, unless otherwise noted				
Parameter	Symbol	Limit	Unit	
Drain-Source Voltage	V_{DS}	- 12	V	
Gate-Source Voltage	V_{GS}	± 8		
Continuous Drain Current ($T_J = 150$ °C)	I_D	$T_C = 25$ °C	- 1.3 ^a	A
		$T_C = 70$ °C	- 1.2	
		$T_A = 25$ °C	- 1.14 ^{b, c}	
		$T_A = 70$ °C	- 0.9 ^{b, c}	
Pulsed Drain Current	I_{DM}	- 3		
Continuous Source-Drain Diode Current	I_S	$T_C = 25$ °C	- 1	
		$T_A = 25$ °C	- 0.6 ^{b, c}	
Maximum Power Dissipation	P_D	$T_C = 25$ °C	1.25	W
		$T_C = 70$ °C	0.8	
		$T_A = 25$ °C	0.74 ^{b, c}	
		$T_A = 70$ °C	0.47 ^{b, c}	
Operating Junction and Storage Temperature Range	T_J, T_{stg}	- 55 to 150	°C	

THERMAL RESISTANCE RATINGS					
Parameter	Symbol	Typical	Maximum	Unit	
Maximum Junction-to-Ambient ^{b, d}	R_{thJA}	130	170	°C/W	
Maximum Junction-to-Foot (Drain)	R_{thJF}	80	100		

Notes:

- Package limited.
- Surface mounted on 1" x 1" FR4 board.
- $t = 5$ s.
- Maximum under steady state conditions is 220 °C/W.

SPECIFICATIONS $T_J = 25\text{ }^\circ\text{C}$, unless otherwise noted						
Parameter	Symbol	Test Conditions	Min.	Typ.	Max.	Unit
Static						
Drain-Source Breakdown Voltage	V_{DS}	$V_{GS} = 0\text{ V}, I_D = -250\text{ }\mu\text{A}$	- 12			V
V_{DS} Temperature Coefficient	$\Delta V_{DS}/T_J$	$I_D = -250\text{ }\mu\text{A}$		- 14		mV/ $^\circ\text{C}$
$V_{GS(th)}$ Temperature Coefficient	$\Delta V_{GS(th)}/T_J$		2			
Gate-Source Threshold Voltage	$V_{GS(th)}$	$V_{DS} = V_{GS}, I_D = -250\text{ }\mu\text{A}$	- 0.4		- 1.0	V
Gate-Source Leakage	I_{GSS}	$V_{DS} = 0\text{ V}, V_{GS} = \pm 8\text{ V}$			± 100	nA
Zero Gate Voltage Drain Current	I_{DSS}	$V_{DS} = -12\text{ V}, V_{GS} = 0\text{ V}$			- 1	μA
		$V_{DS} = -12\text{ V}, V_{GS} = 0\text{ V}, T_J = 85\text{ }^\circ\text{C}$			- 10	
On-State Drain Current ^a	$I_{D(on)}$	$V_{DS} \leq -5\text{ V}, V_{GS} = -4.5\text{ V}$	- 3			A
Drain-Source On-State Resistance ^a	$R_{DS(on)}$	$V_{GS} = -4.5\text{ V}, I_D = -1.0\text{ A}$		0.315	0.390	Ω
		$V_{GS} = -2.5\text{ V}, I_D = -0.86\text{ A}$		0.425	0.535	
		$V_{GS} = -1.8\text{ V}, I_D = -0.25\text{ A}$		0.550	0.710	
Forward Transconductance ^a	g_{fs}	$V_{DS} = -6\text{ V}, I_D = -1.0\text{ A}$		2.5		S
Dynamic^b						
Input Capacitance	C_{iss}	$V_{DS} = -6\text{ V}, V_{GS} = 0\text{ V}, f = 1\text{ MHz}$		120		μF
Output Capacitance	C_{oss}		41			
Reverse Transfer Capacitance	C_{rss}		25			
Total Gate Charge	Q_g	$V_{DS} = -6\text{ V}, V_{GS} = -8\text{ V}, I_D = -1.1\text{ A}$		2.8	4.2	nC
		$V_{DS} = -6\text{ V}, V_{GS} = -4.5\text{ V}, I_D = -1.1\text{ A}$		1.7	2.6	
Gate-Source Charge	Q_{gs}			0.3		
Gate-Drain Charge	Q_{gd}		0.4			
Gate Resistance	R_g	$f = 1\text{ MHz}$		7.5		Ω
Turn-On Delay Time	$t_{d(on)}$	$V_{DD} = -6\text{ V}, R_L = 6.7\text{ }\Omega$ $I_D \cong -0.9\text{ A}, V_{GEN} = -4.5\text{ V}, R_g = 1\text{ }\Omega$		12	20	ns
Rise Time	t_r			27	40	
Turn-Off Delay Time	$t_{d(off)}$			15	25	
Fall Time	t_f			10	15	
Turn-On Delay Time	$t_{d(on)}$	$V_{DD} = -6\text{ V}, R_L = 6.7\text{ }\Omega$ $I_D \cong -0.9\text{ A}, V_{GEN} = -8\text{ V}, R_g = 1\text{ }\Omega$		2	5	
Rise Time	t_r			12	20	
Turn-Off Delay Time	$t_{d(off)}$			12	20	
Fall Time	t_f			10	15	
Drain-Source Body Diode Characteristics						
Continuous Source-Drain Diode Current	I_S	$T_C = 25\text{ }^\circ\text{C}$			- 1.0	A
Pulse Diode Forward Current ^a	I_{SM}				- 3.0	
Body Diode Voltage	V_{SD}	$I_S = -0.9\text{ A}$		- 0.8	- 1.2	V
Body Diode Reverse Recovery Time	t_{rr}	$I_F = -0.9\text{ A}, di/dt = 100\text{ A}/\mu\text{s}, T_J = 25\text{ }^\circ\text{C}$		20	40	ns
Body Diode Reverse Recovery Charge	Q_{rr}			10	20	nC
Reverse Recovery Fall Time	t_a			9.5		ns
Reverse Recovery Rise Time	t_b			11.5		

Notes:

- a. Pulse test; pulse width $\leq 300\text{ }\mu\text{s}$, duty cycle $\leq 2\%$.
b. Guaranteed by design, not subject to production testing.

Stresses beyond those listed under "Absolute Maximum Ratings" may cause permanent damage to the device. These are stress ratings only, and functional operation of the device at these or any other conditions beyond those indicated in the operational sections of the specifications is not implied. Exposure to absolute maximum rating conditions for extended periods may affect device reliability.

TYPICAL CHARACTERISTICS 25 °C, unless otherwise noted

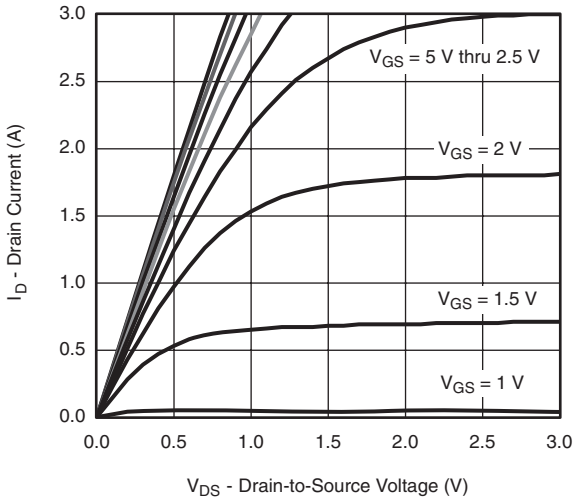

V_{DS} - Drain-to-Source Voltage (V)
Output Characteristics

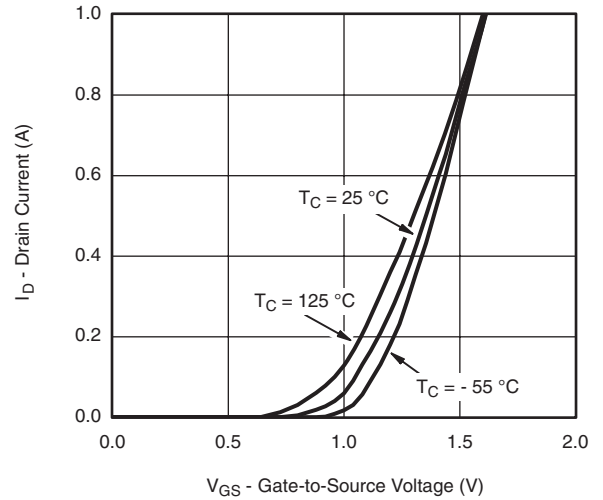

V_{GS} - Gate-to-Source Voltage (V)
Transfer Characteristics

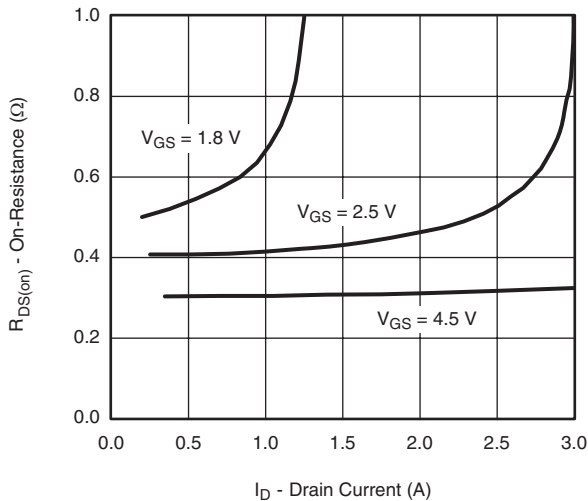

I_D - Drain Current (A)
On-Resistance vs. Drain Current and Gate Voltage

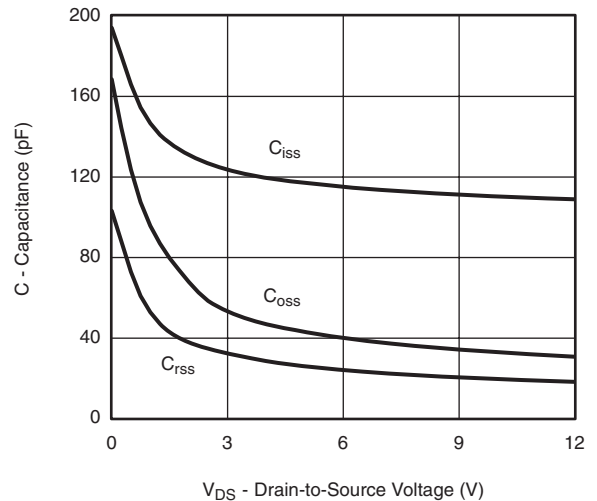

V_{DS} - Drain-to-Source Voltage (V)
Capacitance

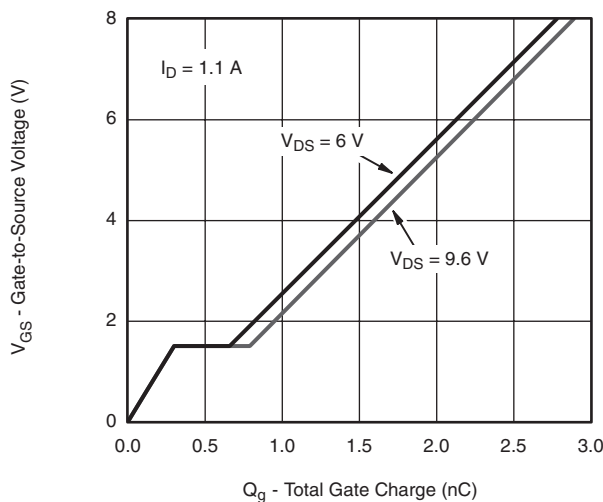

Q_g - Total Gate Charge (nC)
Gate Charge

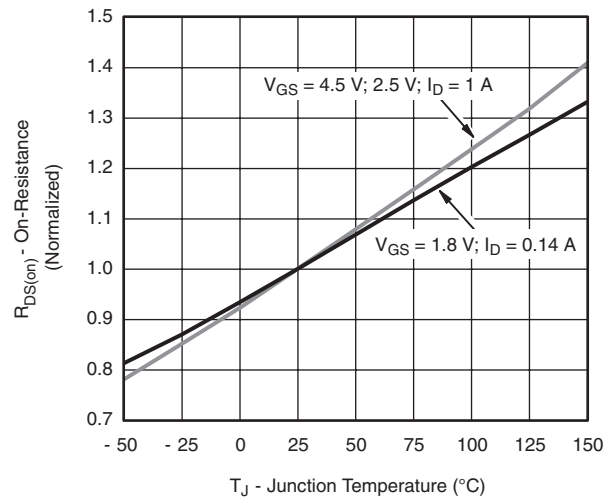

T_J - Junction Temperature ($^{\circ}\text{C}$)
On-Resistance vs. Junction Temperature

TYPICAL CHARACTERISTICS 25 °C, unless otherwise noted

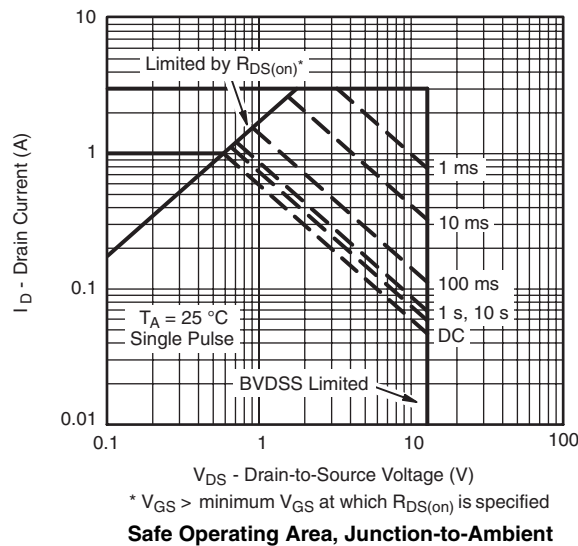
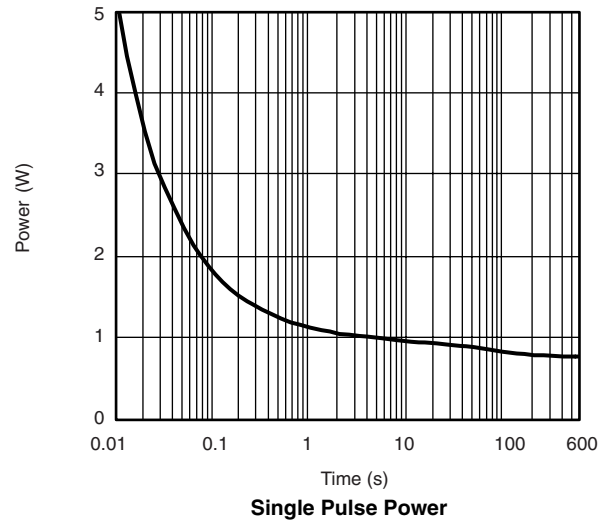
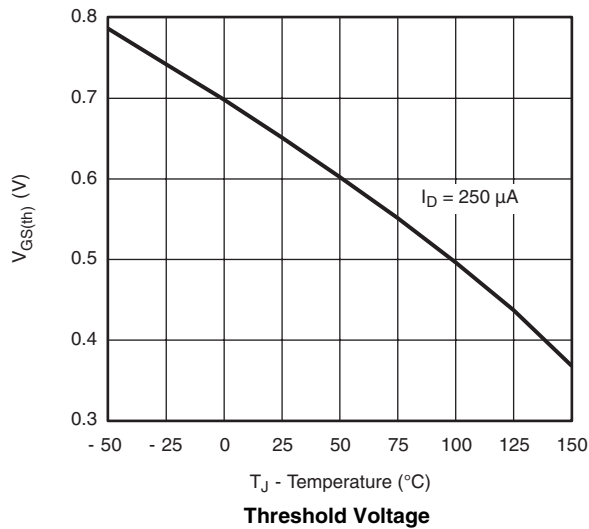
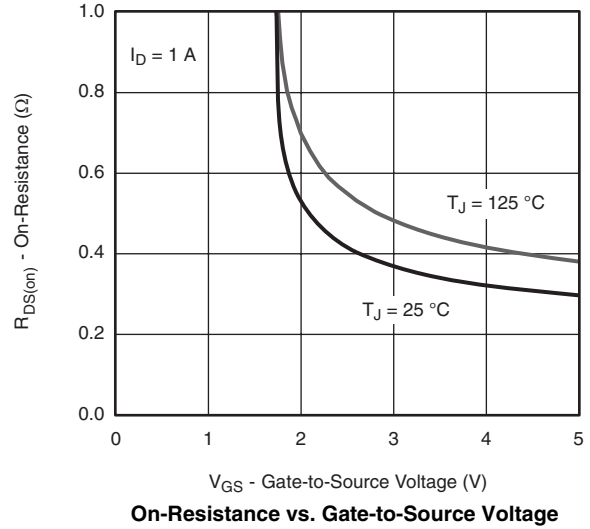
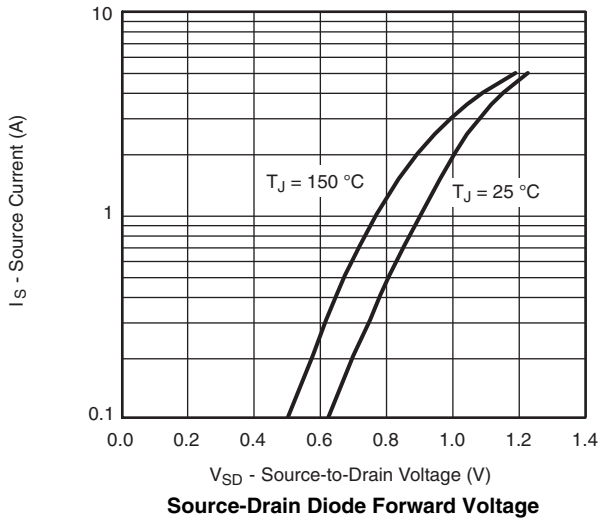

TYPICAL CHARACTERISTICS 25 °C, unless otherwise noted

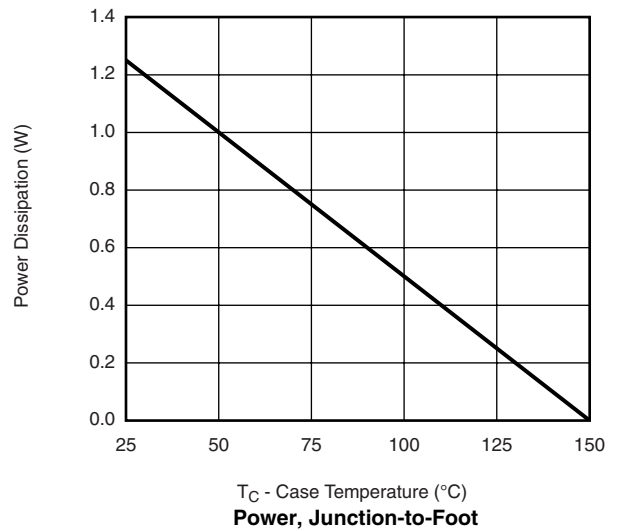
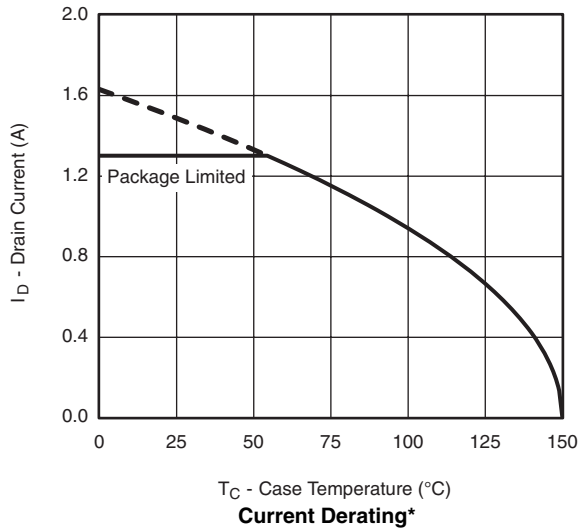

* The power dissipation P_D is based on $T_{J(max)} = 150$ °C, using junction-to-case thermal resistance, and is more useful in settling the upper dissipation limit for cases where additional heatsinking is used. It is used to determine the current rating, when this rating falls below the package limit.

TYPICAL CHARACTERISTICS 25 °C, unless otherwise noted

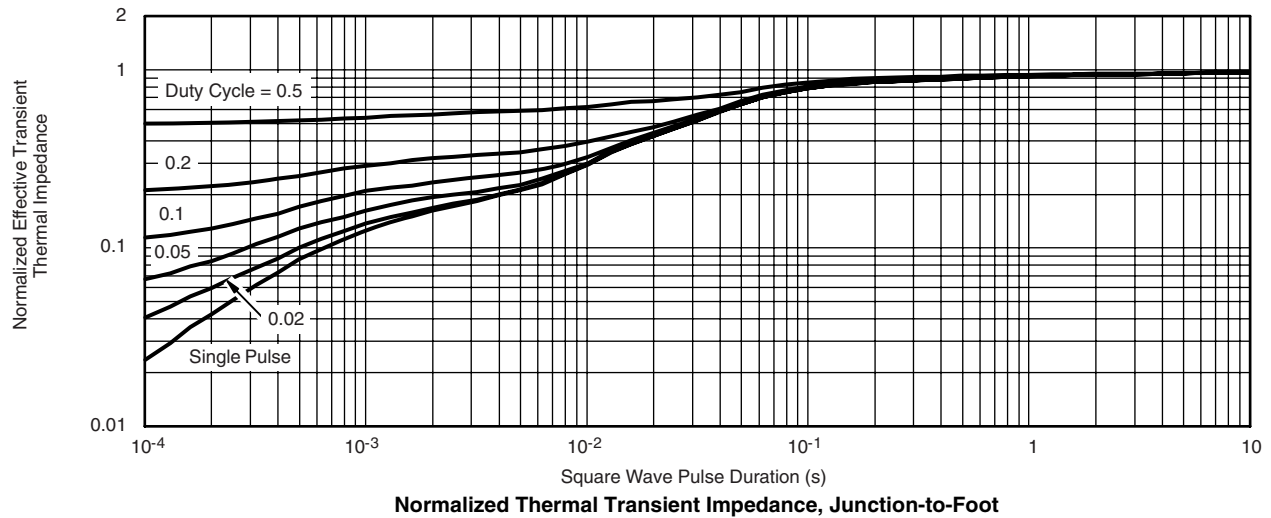
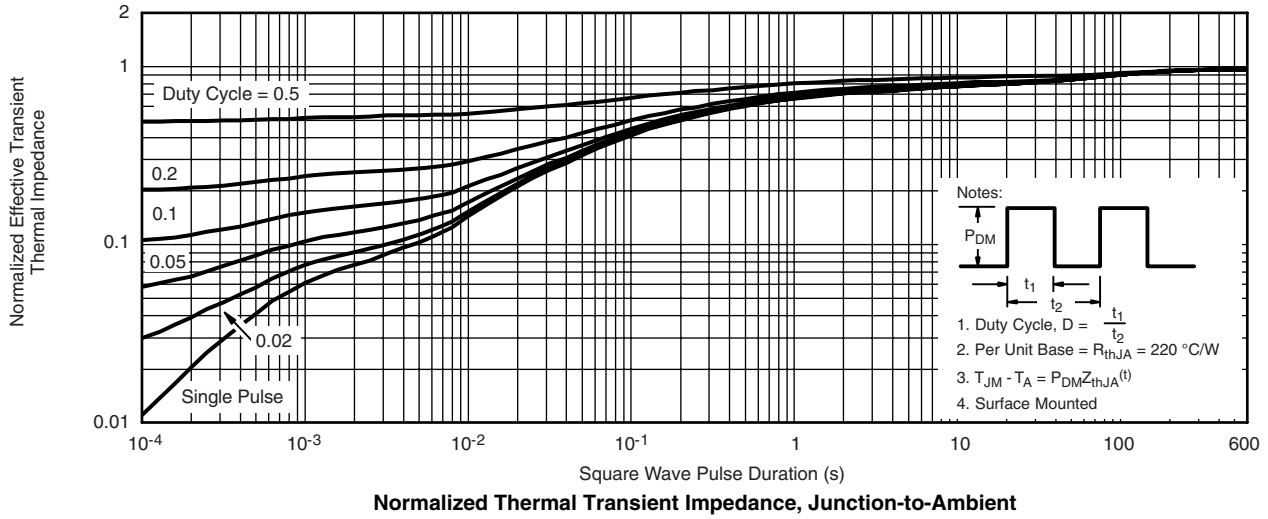

Vishay Siliconix maintains worldwide manufacturing capability. Products may be manufactured at one of several qualified locations. Reliability data for Silicon Technology and Package Reliability represent a composite of all qualified locations. For related documents such as package/tape drawings, part marking, and reliability data, see www.vishay.com/ppq?68765.



Disclaimer

All product specifications and data are subject to change without notice.

Vishay Intertechnology, Inc., its affiliates, agents, and employees, and all persons acting on its or their behalf (collectively, "Vishay"), disclaim any and all liability for any errors, inaccuracies or incompleteness contained herein or in any other disclosure relating to any product.

Vishay disclaims any and all liability arising out of the use or application of any product described herein or of any information provided herein to the maximum extent permitted by law. The product specifications do not expand or otherwise modify Vishay's terms and conditions of purchase, including but not limited to the warranty expressed therein, which apply to these products.

No license, express or implied, by estoppel or otherwise, to any intellectual property rights is granted by this document or by any conduct of Vishay.

The products shown herein are not designed for use in medical, life-saving, or life-sustaining applications unless otherwise expressly indicated. Customers using or selling Vishay products not expressly indicated for use in such applications do so entirely at their own risk and agree to fully indemnify Vishay for any damages arising or resulting from such use or sale. Please contact authorized Vishay personnel to obtain written terms and conditions regarding products designed for such applications.

Product names and markings noted herein may be trademarks of their respective owners.