



Chipsmall Limited consists of a professional team with an average of over 10 year of expertise in the distribution of electronic components. Based in Hongkong, we have already established firm and mutual-benefit business relationships with customers from,Europe,America and south Asia,supplying obsolete and hard-to-find components to meet their specific needs.

With the principle of “Quality Parts,Customers Priority,Honest Operation,and Considerate Service”,our business mainly focus on the distribution of electronic components. Line cards we deal with include Microchip,ALPS,ROHM,Xilinx,Pulse,ON,Everlight and Freescale. Main products comprise IC,Modules,Potentiometer,IC Socket,Relay,Connector.Our parts cover such applications as commercial,industrial, and automotives areas.

We are looking forward to setting up business relationship with you and hope to provide you with the best service and solution. Let us make a better world for our industry!



Contact us

Tel: +86-755-8981 8866 Fax: +86-755-8427 6832

Email & Skype: info@chipsmall.com Web: www.chipsmall.com

Address: A1208, Overseas Decoration Building, #122 Zhenhua RD., Futian, Shenzhen, China





Si861x/2x Data Sheet

Low-Power Single and Dual-Channel Digital Isolators

Silicon Lab's family of ultra-low-power digital isolators are CMOS devices offering substantial data rate, propagation delay, power, size, reliability, and external BOM advantages over legacy isolation technologies. The operating parameters of these products remain stable across wide temperature ranges and throughout device service life for ease of design and highly uniform performance. All device versions have Schmitt trigger inputs for high noise immunity and only require VDD bypass capacitors.

Data rates up to 150 Mbps are supported, and all devices achieve propagation delays of less than 10 ns. Ordering options include a choice of isolation ratings (2.5, 3.75 and 5 kV) and a selectable fail-safe operating mode to control the default output state during power loss. All products are safety certified by UL, CSA, VDE, and CQC, and products in wide-body packages support reinforced insulation withstanding up to 5 kV_{RMS}.

Applications

- Industrial automation systems
- Medical electronics
- Hybrid electric vehicles
- Isolated switch mode supplies
- Isolated ADC, DAC
- Motor control
- Power inverters
- Communications systems

Safety Regulatory Approvals

- UL 1577 recognized
 - Up to 5000 V_{RMS} for 1 minute
- CSA component notice 5A approval
 - IEC 60950-1, 61010-1, 60601-1 (reinforced insulation)
- VDE certification conformity
 - Si862xxT options certified to reinforced VDE 0884-10
 - All other options certified to IEC 60747-5-5 and reinforced 60950-1
- CQC certification approval
 - GB4943.1

KEY FEATURES

- High-speed operation
 - DC to 150 Mbps
- No start-up initialization required
- Wide Operating Supply Voltage
 - 2.5–5.5 V
- Up to 5000 V_{RMS} isolation
- Reinforced VDE 0884-10, 10 kV surge-capable (Si862xxT)
- 60-year life at rated working voltage
- High electromagnetic immunity
- Ultra low power (typical)

5 V Operation

- 1.6 mA per channel at 1 Mbps
- 5.5 mA per channel at 100 Mbps

2.5 V Operation

- 1.5 mA per channel at 1 Mbps
- 3.5 mA per channel at 100 Mbps

- Schmitt trigger inputs
- Selectable fail-safe mode
 - Default high or low output (ordering option)
- Precise timing (typical)
 - 10 ns propagation delay
 - 1.5 ns pulse width distortion
 - 0.5 ns channel-channel skew
 - 2 ns propagation delay skew
 - 5 ns minimum pulse width
- Transient Immunity 50 kV/μs
- AEC-Q100 qualification
- Wide temperature range
 - –40 to 125 °C
- RoHS-compliant packages
 - SOIC-16 wide body
 - SOIC-8 narrow body

1. Ordering Guide

Table 1.1. Ordering Guide for Valid OPNs^{1, 2}

Ordering Part Number (OPN)	Number of Inputs VDD1 Side	Number of Inputs VDD2 Side	Max Data Rate (Mbps)	Default Output State	Isolation Rating (kV)	Temp (C)	Package
Si8610BB-B-IS	1	0	150	Low	2.5	-40 to 125 °C	SOIC-8
Si8610BC-B-IS	1	0	150	Low	3.75	-40 to 125 °C	SOIC-8
Si8610EC-B-IS	1	0	150	High	3.75	-40 to 125 °C	SOIC-8
Si8610BD-B-IS	1	0	150	Low	5.0	-40 to 125 °C	WB SOIC-16
Si8610ED-B-IS	1	0	150	High	5.0	-40 to 125 °C	WB SOIC-16
Si8620BB-B-IS	2	0	150	Low	2.5	-40 to 125 °C	SOIC-8
Si8620EB-B-IS	2	0	150	High	2.5	-40 to 125 °C	SOIC-8
Si8620BC-B-IS	2	0	150	Low	3.75	-40 to 125 °C	SOIC-8
Si8620EC-B-IS	2	0	150	High	3.75	-40 to 125 °C	SOIC-8
Si8620BD-B-IS	2	0	150	Low	5.0	-40 to 125 °C	WB SOIC-16
Si8620ED-B-IS	2	0	150	High	5.0	-40 to 125 °C	WB SOIC-16
Si8621BB-B-IS	1	1	150	Low	2.5	-40 to 125 °C	SOIC-8
Si8621BC-B-IS	1	1	150	Low	3.75	-40 to 125 °C	SOIC-8
Si8621EC-B-IS	1	1	150	High	3.75	-40 to 125 °C	SOIC-8
Si8621BD-B-IS	1	1	150	Low	5.0	-40 to 125 °C	WB SOIC-16
Si8621ED-B-IS	1	1	150	High	5.0	-40 to 125 °C	WB SOIC-16
Si8622BB-B-IS	1	1	150	Low	2.5	-40 to 125 °C	SOIC-8
Si8622EB-B-IS	1	1	150	High	2.5	-40 to 125 °C	SOIC-8
Si8622BC-B-IS	1	1	150	Low	3.75	-40 to 125 °C	SOIC-8
Si8622EC-B-IS	1	1	150	High	3.75	-40 to 125 °C	SOIC-8
Si8622BD-B-IS	1	1	150	Low	5.0	-40 to 125 °C	WB SOIC-16
Si8622ED-B-IS	1	1	150	High	5.0	-40 to 125 °C	WB SOIC-16
Product Options with Reinforced VDE 0884-10 Rating with 10 kV Surge Capability							
Si8620BT-IS	2	0	150	Low	5.0	-40 to 125 °C	WB SOIC-16
Si8620ET-IS	2	0	150	High	5.0	-40 to 125 °C	WB SOIC-16
Si8621BT-IS	1	1	150	Low	5.0	-40 to 125 °C	WB SOIC-16
Si8621ET-IS	1	1	150	High	5.0	-40 to 125 °C	WB SOIC-16
Si8622BT-IS	1	1	150	Low	5.0	-40 to 125 °C	WB SOIC-16
Si8622ET-IS	1	1	150	High	5.0	-40 to 125 °C	WB SOIC-16

Ordering Part Number (OPN)	Number of Inputs VDD1 Side	Number of Inputs VDD2 Side	Max Data Rate (Mbps)	Default Output State	Isolation Rating (kV)	Temp (C)	Package
----------------------------	----------------------------	----------------------------	----------------------	----------------------	-----------------------	----------	---------

Note:

1. All packages are RoHS-compliant with peak reflow temperatures of 260 °C according to the JEDEC industry standard classifications and peak solder temperatures.
2. "Si" and "SI" are used interchangeably.
3. An "R" at the end of the part number denotes tape and reel packaging option.

2. System Overview

2.1 Theory of Operation

The operation of an Si861x/2x channel is analogous to that of an opto coupler, except an RF carrier is modulated instead of light. This simple architecture provides a robust isolated data path and requires no special considerations or initialization at start-up. A simplified block diagram for a single Si861x/2x channel is shown in the figure below.

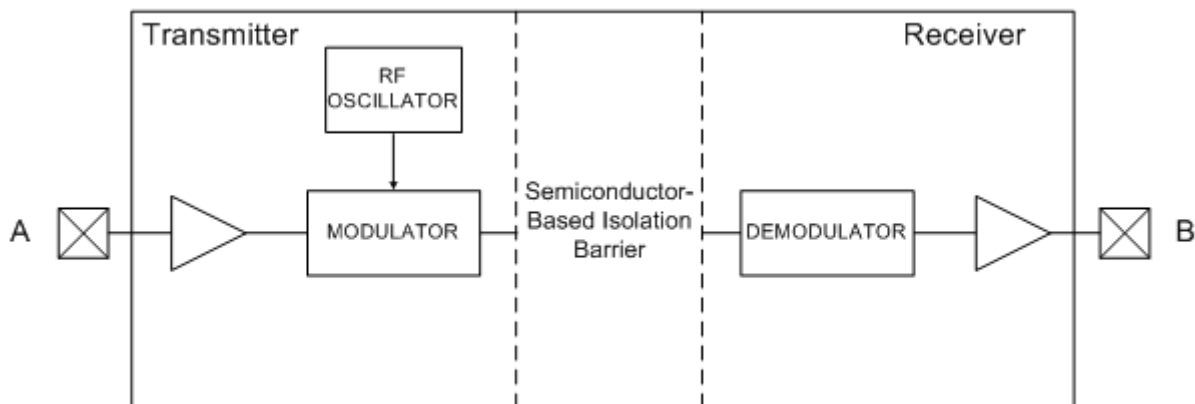

Figure 2.1. Simplified Channel Diagram

A channel consists of an RF Transmitter and RF Receiver separated by a semiconductor-based isolation barrier. Referring to the transmitter, input A modulates the carrier provided by an RF oscillator using on/off keying. The Receiver contains a demodulator that decodes the input state according to its RF energy content and applies the result to output B via the output driver. This RF on/off keying scheme is superior to pulse code schemes as it provides best-in-class noise immunity, low power consumption, and improved immunity to magnetic fields. See the following figure for more details.

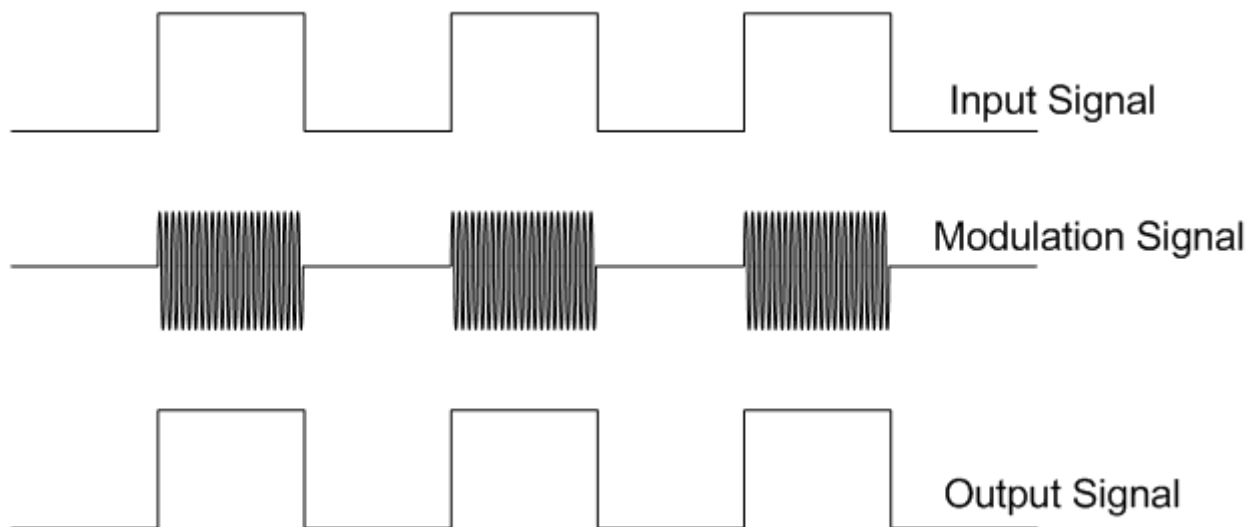

Figure 2.2. Modulation Scheme

2.2 Eye Diagram

The figure below illustrates an eye diagram taken on an Si8610. For the data source, the test used an Anritsu (MP1763C) Pulse Pattern Generator set to 1000 ns/div. The output of the generator's clock and data from an Si8610 were captured on an oscilloscope. The results illustrate that data integrity was maintained even at the high data rate of 150 Mbps. The results also show that 2 ns pulse width distortion and 350 ps peak jitter were exhibited.

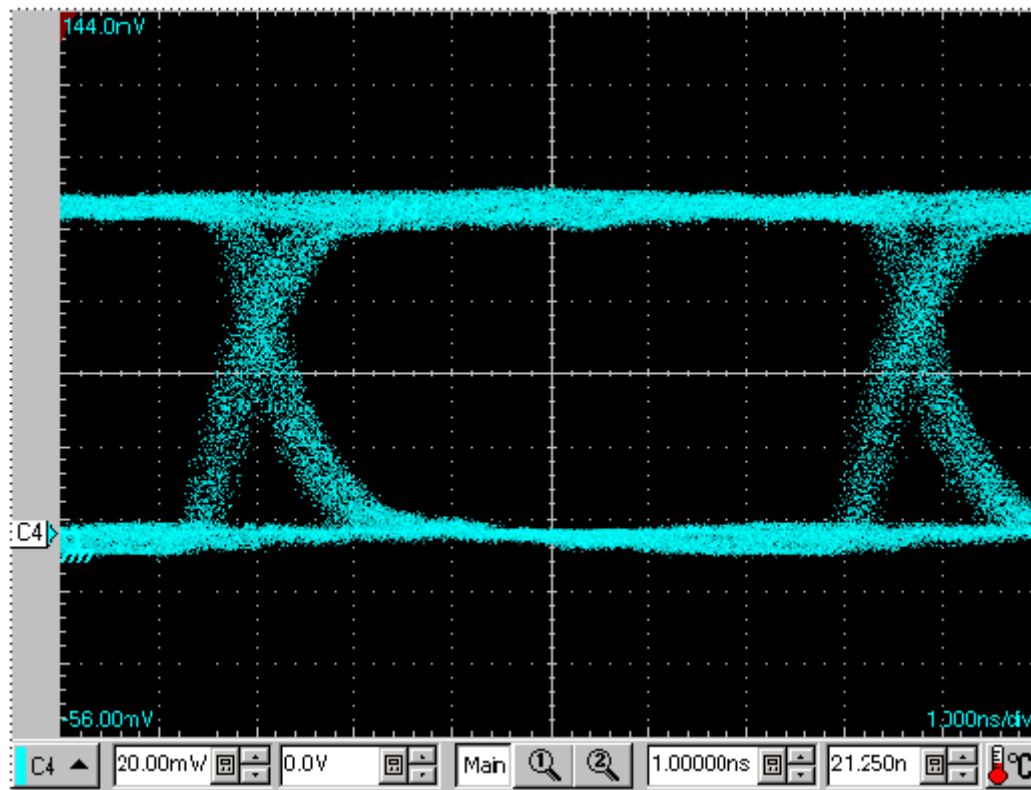

Figure 2.3. Eye Diagram

3. Device Operation

Device behavior during start-up, normal operation, and shutdown is shown in [Figure 3.1 Device Behavior during Normal Operation on page 6](#), where UVLO+ and UVLO– are the respective positive-going and negative-going thresholds. Refer to the following table to determine outputs when power supply (VDD) is not present.

Table 3.1. Si86xx Logic Operation

V _I Input ^{1, 2}	VDDI State ^{1, 3, 4}	VDDO State ^{1, 3, 4}	V _O Output ^{1, 2}	Comments
H	P	P	H	Normal operation.
L	P	P	L	
X ⁵	UP	P	L ⁶ H ⁶	Upon transition of VDDI from unpowered to powered, V _O returns to the same state as V _I in less than 1 μs.
X ⁵	P	UP	Undetermined	Upon transition of VDDO from unpowered to powered, V _O returns to the same state as V _I within 1 μs.

Note:

- VDDI and VDDO are the input and output power supplies. VI and VO are the respective input and output terminals.
- X = not applicable; H = Logic High; L = Logic Low; Hi-Z = High Impedance.
- “Powered” state (P) is defined as 2.5 V < VDD < 5.5 V.
- “Unpowered” state (UP) is defined as VDD = 0 V.
- Note that an I/O can power the die for a given side through an internal diode if its source has adequate current.
- See Ordering Guide for details. This is the selectable fail-safe operating mode (ordering option). Some devices have default output state = H, and some have default output state = L, depending on the ordering part number (OPN). For default high devices, the data channels have pull-ups on inputs/outputs. For default low devices, the data channels have pull-downs on inputs/outputs.

3.1 Device Startup

Outputs are held low during powerup until VDD is above the UVLO threshold for time period t_{START} . Following this, the outputs follow the states of inputs.

3.2 Undervoltage Lockout

Undervoltage Lockout (UVLO) is provided to prevent erroneous operation during device startup and shutdown or when VDD is below its specified operating circuits range. Both Side A and Side B each have their own undervoltage lockout monitors. Each side can enter or exit UVLO independently. For example, Side A unconditionally enters UVLO when V_{DD1} falls below $V_{DD1(UVLO-)}$ and exits UVLO when V_{DD1} rises above $V_{DD1(UVLO+)}$. Side B operates the same as Side A with respect to its V_{DD2} supply.

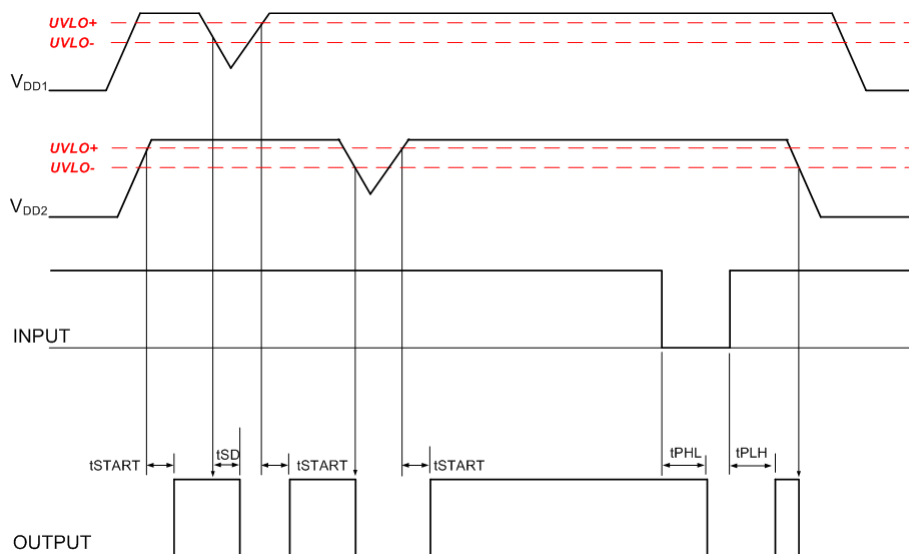

Figure 3.1. Device Behavior during Normal Operation

3.3 Layout Recommendations

To ensure safety in the end-user application, high-voltage circuits (i.e., circuits with $>30 V_{AC}$) must be physically separated from the safety extra-low-voltage circuits (SELV is a circuit with $<30 V_{AC}$) by a certain distance (creepage/clearance). If a component, such as a digital isolator, straddles this isolation barrier, it must meet those creepage/clearance requirements and also provide a sufficiently large high-voltage breakdown protection rating (commonly referred to as working voltage protection). [Table 4.6 Insulation and Safety-Related Specifications on page 22](#) and [Table 4.8 IEC 60747-5-5 Insulation Characteristics for Si86xxx¹ on page 23](#) detail the working voltage and creepage/clearance capabilities of the Si86xx. These tables also detail the component standards (UL1577, IEC60747, CSA 5A), which are readily accepted by certification bodies to provide proof for end-system specifications requirements. Refer to the end-system specification (61010-1, 60950-1, 60601-1, etc.) requirements before starting any design that uses a digital isolator.

3.3.1 Supply Bypass

The Si861x/2x family requires a 0.1 μF bypass capacitor between V_{DD1} and GND1 and V_{DD2} and GND2. The capacitor should be placed as close as possible to the package. To enhance the robustness of a design, the user may also include resistors (50–300 Ω) in series with the inputs and outputs if the system is excessively noisy.

3.3.2 Output Pin Termination

The nominal output impedance of an isolator driver channel is approximately 50 Ω , $\pm 40\%$, which is a combination of the value of the on-chip series termination resistor and channel resistance of the output driver FET. When driving loads where transmission line effects will be a factor, output pins should be appropriately terminated with controlled impedance PCB traces.

3.4 Fail-Safe Operating Mode

Si86xx devices feature a selectable (by ordering option) mode whereby the default output state (when the input supply is unpowered) can either be a logic high or logic low when the output supply is powered. See [Table 3.1 Si86xx Logic Operation on page 5](#) and [1. Ordering Guide](#) for more information.

3.5 Typical Performance Characteristics

The typical performance characteristics depicted in the following diagrams are for information purposes only. Refer to 4. [Electrical Specifications](#) for actual specification limits.

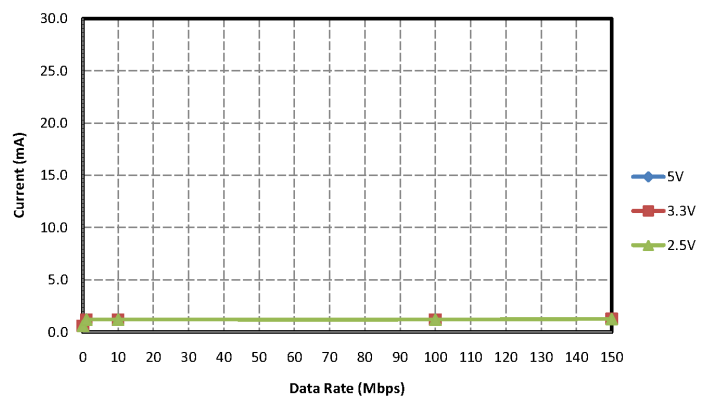

Figure 3.2. Si8610 Typical V_{DD1} Supply Current vs. Data Rate 5, 3.3, and 2.50 V Operation

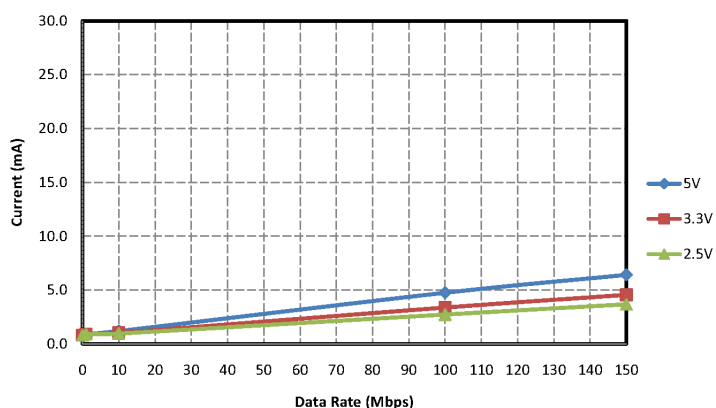

Figure 3.3. Si8610 Typical V_{DD2} Supply Current vs. Data Rate 5, 3.3, and 2.50 V Operation (15 pF Load)

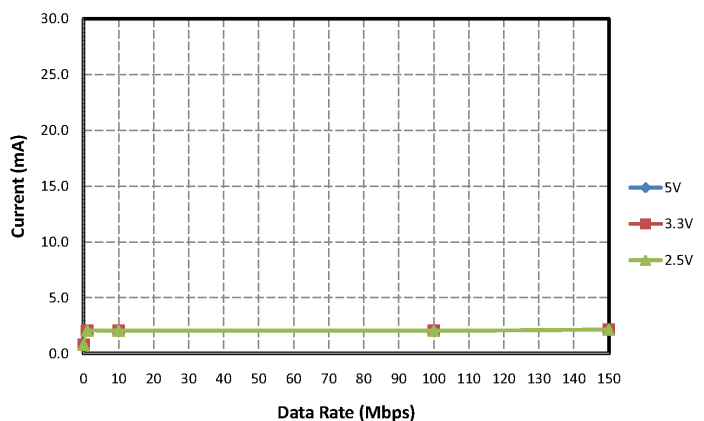

Figure 3.4. Si8620 Typical V_{DD1} Supply Current vs. Data Rate 5, 3.3, and 2.50 V Operation

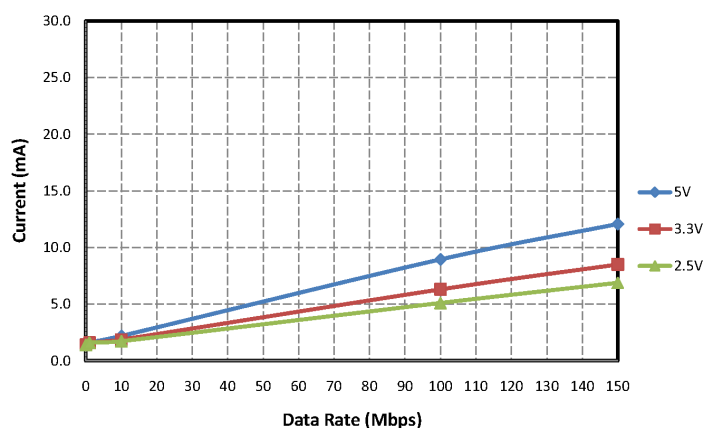

Figure 3.5. Si8620 Typical V_{DD2} Supply Current vs. Data Rate 5, 3.3, and 2.50 V Operation (15 pF Load)

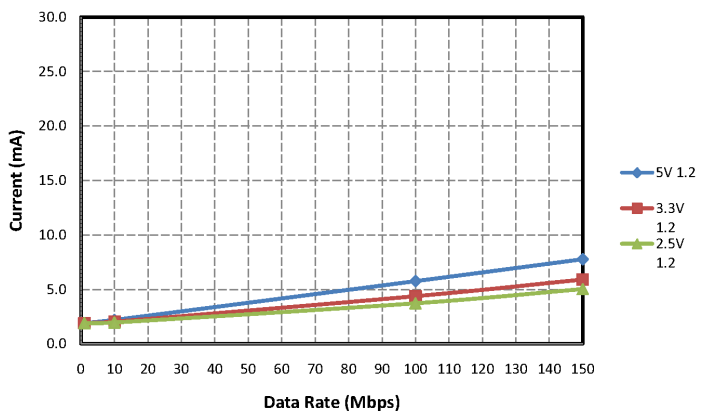

Figure 3.6. Si8621 Typical V_{DD1} or V_{DD2} Supply Current vs. Data Rate 5, 3.3, and 2.50 V Operation (15 pF Load)

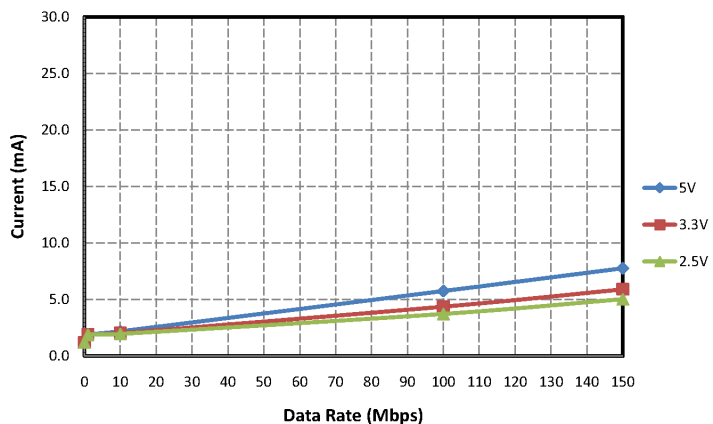

Figure 3.7. Si8622 Typical V_{DD1} or V_{DD2} Supply Current vs. Data Rate 5, 3.3, and 2.50 V Operation (15 pF Load)

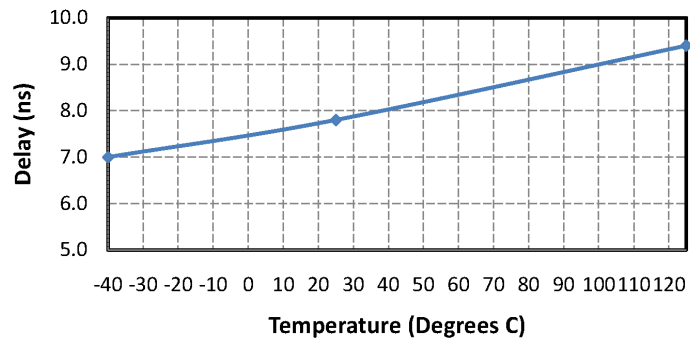

Figure 3.8. Propagation Delay vs. Temperature (5.0 V Data)

4. Electrical Specifications

Table 4.1. Recommended Operating Conditions

Parameter	Symbol	Min	Typ	Max	Unit
Ambient Operating Temperature ¹	TA	-40	25	125 ¹	°C
Supply Voltage	VDD1	2.5	—	5.5	V
	VDD2	2.5	—	5.5	V

Note:
1. The maximum ambient temperature is dependent on data frequency, output loading, number of operating channels, and supply voltage.

Table 4.2. Electrical Characteristics¹

Parameter	Symbol	Test Condition	Min	Typ	Max	Unit
VDD Undervoltage Threshold	VDD _{UV+}	V _{DD1} , V _{DD2} rising	1.95	2.24	2.375	V
VDD Undervoltage Threshold	VDD _{UV-}	V _{DD1} , V _{DD2} falling	1.88	2.16	2.325	V
VDD Undervoltage Hysteresis	VDD _{HYS}		50	70	95	mV
Positive-Going Input Threshold	VT+	All inputs rising	1.4	1.67	1.9	V
Negative-Going Input Threshold	VT-	All inputs falling	1.0	1.23	1.4	V
Input Hysteresis	V _{HYS}		0.38	0.44	0.50	V
High Level Input Voltage	V _{IH}		2.0	—	—	V
Low Level Input Voltage	V _{IL}		—	—	0.8	V
High Level Output Voltage	V _{OH}	I _{oh} = -4 mA	V _{DD1} , V _{DD2} - 0.4	4.8	—	V
Low Level Output Voltage	V _{OL}	I _{ol} = 4 mA	—	0.2	0.4	V
Input Leakage Current	I _L					
Si86xxxB/C/D			—	—	±10	μA
Si86xxxT		—	—	±15		
Output Impedance ²	Z _O		—	50	—	Ω
DC Supply Current (All Inputs 0 V or at Supply)						
Si8610Bx, Ex						
V _{DD1}		V _I = 0(Bx), 1(Ex)	—	0.6	1.2	mA
V _{DD2}		V _I = 0(Bx), 1(Ex)	—	0.8	1.5	
V _{DD1}		V _I = 1(Bx), 0(Ex)	—	1.8	2.9	
V _{DD2}		V _I = 1(Bx), 0(Ex)	—	0.8	1.5	

Parameter	Symbol	Test Condition	Min	Typ	Max	Unit
Si8620Bx, Ex						
V_{DD1}		$V_I = 0(\text{Bx}), 1(\text{Ex})$	—	0.8	1.4	mA
V_{DD2}		$V_I = 0(\text{Bx}), 1(\text{Ex})$	—	1.4	2.2	
V_{DD1}		$V_I = 1(\text{Bx}), 0(\text{Ex})$	—	3.3	5.3	
V_{DD2}		$V_I = 1(\text{Bx}), 0(\text{Ex})$	—	1.4	2.2	
Si8621Bx, Ex						
V_{DD1}		$V_I = 0(\text{Bx}), 1(\text{Ex})$	—	1.2	1.9	mA
V_{DD2}		$V_I = 0(\text{Bx}), 1(\text{Ex})$	—	1.2	1.9	
V_{DD1}		$V_I = 1(\text{Bx}), 0(\text{Ex})$	—	2.4	3.8	
V_{DD2}		$V_I = 1(\text{Bx}), 0(\text{Ex})$	—	2.4	3.8	
Si8622Bx, Ex						
V_{DD1}		$V_I = 0(\text{Bx}), 1(\text{Ex})$	—	2.6	4.2	mA
V_{DD2}		$V_I = 0(\text{Bx}), 1(\text{Ex})$	—	3.3	5.3	
V_{DD1}		$V_I = 1(\text{Bx}), 0(\text{Ex})$	—	4.0	6.4	
V_{DD2}		$V_I = 1(\text{Bx}), 0(\text{Ex})$	—	4.8	7.7	
1 Mbps Supply Current (All Inputs = 500 kHz Square Wave, CI = 15 pF on All Outputs)						
Si8610Bx, Ex						
V_{DD1}			—	1.2	2.0	mA
V_{DD2}			—	0.9	1.5	
Si8620Bx, Ex						
V_{DD1}			—	2.1	3.1	mA
V_{DD2}			—	1.6	2.4	
Si8621Bx, Ex						
V_{DD1}			—	1.9	2.9	mA
V_{DD2}			—	1.9	2.9	
Si8622Bx, Ex						
V_{DD1}			—	3.4	5.1	mA
V_{DD2}			—	4.2	6.2	
10 Mbps Supply Current (All Inputs = 5 MHz Square Wave, CI = 15 pF on All Outputs)						
Si8610Bx, Ex						
V_{DD1}			—	1.2	2.0	mA
V_{DD2}			—	1.2	2.0	
Si8620Bx, Ex						
V_{DD1}			—	2.1	3.1	mA
V_{DD2}			—	2.2	3.3	

Parameter	Symbol	Test Condition	Min	Typ	Max	Unit
Si8621Bx, Ex						
V_{DD1}			—	2.2	3.3	mA
V_{DD2}			—	2.2	3.3	
Si8622Bx, Ex						
V_{DD1}			—	3.7	5.5	mA
V_{DD2}			—	4.4	6.7	
100 Mbps Supply Current (All Inputs = 50 MHz Square Wave, CI = 15 pF on All Outputs)						
Si8610Bx, Ex						
V_{DD1}			—	1.2	2.0	mA
V_{DD2}			—	4.8	6.7	
Si8620Bx, Ex						
V_{DD1}			—	2.1	3.1	mA
V_{DD2}			—	8.9	12.5	
Si8621Bx, Ex						
V_{DD1}			—	5.8	8.1	mA
V_{DD2}			—	5.8	8.1	
Si8622Bx, Ex						
V_{DD1}			—	7.6	10.6	mA
V_{DD2}			—	8.2	11.4	
Timing Characteristics						
Si861x/2x Bx, Ex						
Maximum Data Rate			0	—	150	Mbps
Minimum Pulse Width			—	—	5.0	ns
Propagation Delay	t_{PHL} , t_{PLH}	See Figure 4.1 Propagation Delay Timing on page 13	5.0	8.0	13	ns
Pulse Width Distortion $ t_{PLH} - t_{PHL} $	PWD	See Figure 4.1 Propagation Delay Timing on page 13	—	0.2	4.5	ns
Propagation Delay Skew ³	$t_{PSK(P-P)}$		—	2.0	4.5	ns
Channel-Channel Skew	t_{PSK}		—	0.4	2.5	ns
All Models						
Output Rise Time	t_r	$C_L = 15$ pF See Figure 4.1 Propagation Delay Timing on page 13	—	2.5	4.0	ns

Parameter	Symbol	Test Condition	Min	Typ	Max	Unit
Output Fall Time	t_f	$C_L = 15 \text{ pF}$ See Figure 4.1 Propagation Delay Timing on page 13	—	2.5	4.0	ns
Peak Eye Diagram Jitter	$t_{\text{JIT(PK)}}$	See Figure 2.3 Eye Diagram on page 4	—	350	—	ps
Common Mode Transient Immunity Si86xxxB/C/D Si86xxxT	CMTI	$V_I = V_{\text{DD}}$ or 0 V $V_{\text{CM}} = 1500 \text{ V}$ See Figure 4.2 Common-Mode Transient Immunity Test Circuit on page 13	35 60	50 100	— —	kV/ μs
Start-up Time ⁴	t_{SU}		—	15	40	μs

Note:

- $V_{\text{DD1}} = 5 \text{ V} \pm 10\%$; $V_{\text{DD2}} = 5 \text{ V} \pm 10\%$, $T_A = -40$ to $125 \text{ }^\circ\text{C}$
- The nominal output impedance of an isolator driver channel is approximately $50 \text{ } \Omega$, $\pm 40\%$, which is a combination of the value of the on-chip series termination resistor and channel resistance of the output driver FET. When driving loads where transmission line effects will be a factor, output pins should be appropriately terminated with controlled-impedance PCB traces.
- $t_{\text{PSK(P-P)}}$ is the magnitude of the difference in propagation delay times measured between different units operating at the same supply voltages, load, and ambient temperature.
- Start-up time is the time period from the application of power to the appearance of valid data at the output.

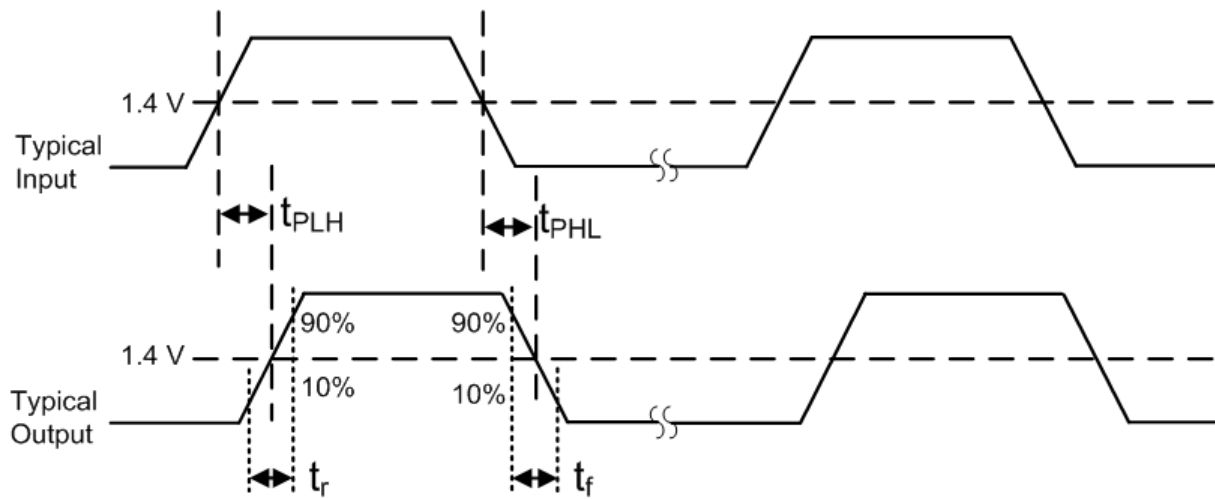

Figure 4.1. Propagation Delay Timing

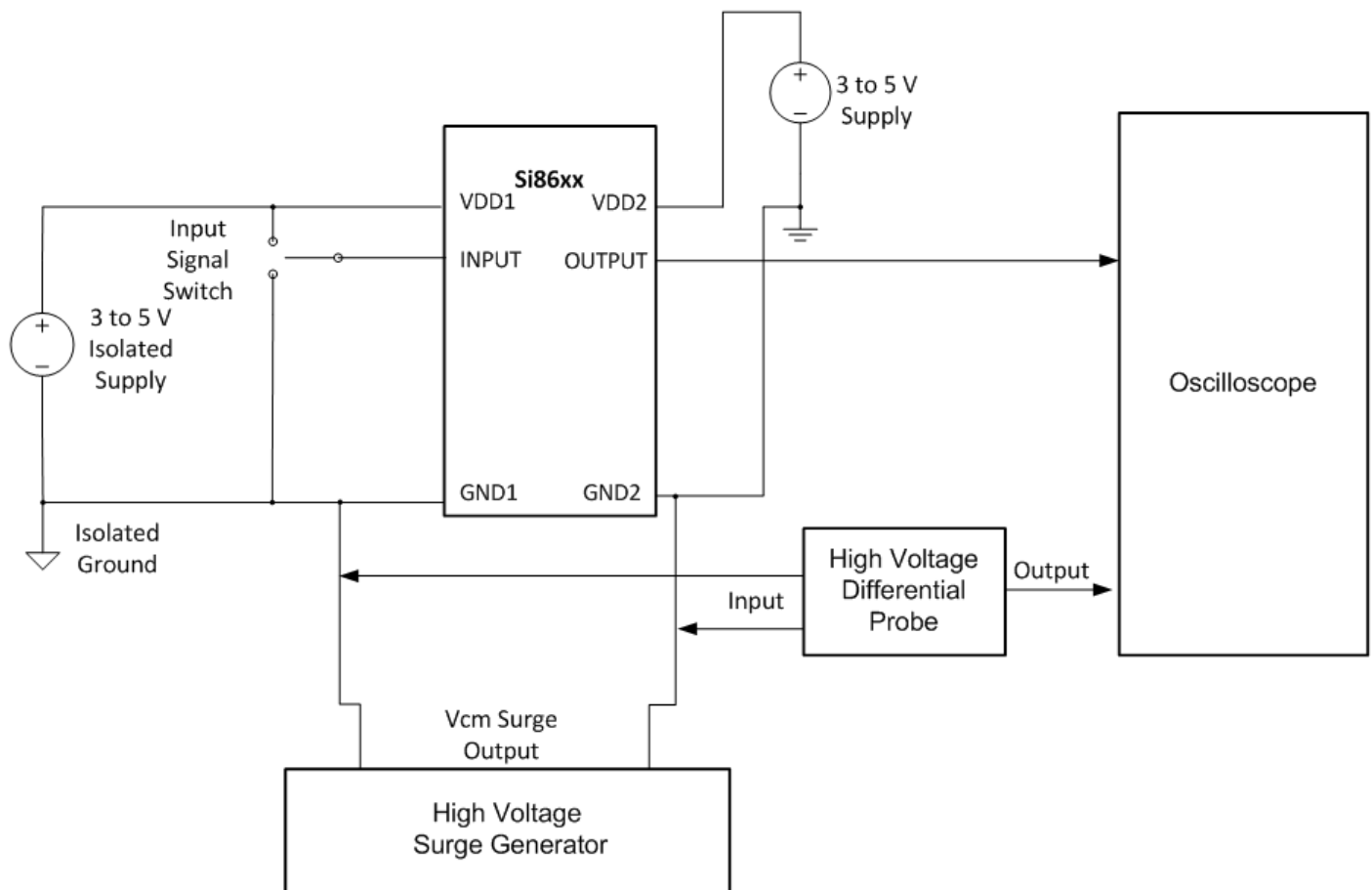

Figure 4.2. Common-Mode Transient Immunity Test Circuit

Table 4.3. Electrical Characteristics¹

Parameter	Symbol	Test Condition	Min	Typ	Max	Unit
VDD Undervoltage Threshold	VDD _{UV+}	V _{DD1} , V _{DD2} rising	1.95	2.24	2.375	V
VDD Undervoltage Threshold	VDD _{UV-}	V _{DD1} , V _{DD2} falling	1.88	2.16	2.325	V
VDD Undervoltage Hysteresis	VDD _{HYS}		50	70	95	mV
Positive-Going Input Threshold	V _{T+}	All inputs rising	1.4	1.67	1.9	V
Negative-Going Input Threshold	V _{T-}	All inputs falling	1.0	1.23	1.4	V
Input Hysteresis	V _{HYS}		0.38	0.44	0.50	V
High Level Input Voltage	V _{IH}		2.0	—	—	V
Low Level Input Voltage	V _{IL}		—	—	0.8	V
High Level Output Voltage	V _{OH}	I _{oh} = -4 mA	V _{DD1} , V _{DD2} - 0.4	3.1	—	V
Low Level Output Voltage	V _{OL}	I _{ol} = 4 mA	—	0.2	0.4	V
Input Leakage Current						
Si86xxxB/C/D	I _L		—	—	±10	μA
Si86xxxT			—	—	±15	
Output Impedance ²	Z _O		—	50	—	Ω
DC Supply Current (All Inputs 0 V or at Supply)						
Si8610Bx, Ex						
V _{DD1}		V _I = 0(Bx), 1(Ex)	—	0.6	1.2	mA
V _{DD2}		V _I = 0(Bx), 1(Ex)	—	0.8	1.5	
V _{DD1}		V _I = 1(Bx), 0(Ex)	—	1.8	2.9	
V _{DD2}		V _I = 1(Bx), 0(Ex)	—	0.8	1.5	
Si8620Bx, Ex						
V _{DD1}		V _I = 0(Bx), 1(Ex)	—	0.8	1.4	mA
V _{DD2}		V _I = 0(Bx), 1(Ex)	—	1.4	2.2	
V _{DD1}		V _I = 1(Bx), 0(Ex)	—	3.3	5.3	
V _{DD2}		V _I = 1(Bx), 0(Ex)	—	1.4	2.2	
Si8621Bx, Ex						
V _{DD1}		V _I = 0(Bx), 1(Ex)	—	1.2	1.9	mA
V _{DD2}		V _I = 0(Bx), 1(Ex)	—	1.2	1.9	
V _{DD1}		V _I = 1(Bx), 0(Ex)	—	2.4	3.8	
V _{DD2}		V _I = 1(Bx), 0(Ex)	—	2.4	3.8	

Parameter	Symbol	Test Condition	Min	Typ	Max	Unit
Si8622Bx, Ex						
V_{DD1}		$V_I = 0(\text{Bx}), 1(\text{Ex})$	—	2.6	4.2	mA
V_{DD2}		$V_I = 0(\text{Bx}), 1(\text{Ex})$	—	3.3	5.3	
V_{DD1}		$V_I = 1(\text{Bx}), 0(\text{Ex})$	—	4.0	6.4	
V_{DD2}		$V_I = 1(\text{Bx}), 0(\text{Ex})$	—	4.8	7.7	
1 Mbps Supply Current (All Inputs = 500 kHz Square Wave, CI = 15 pF on All Outputs)						
Si8610Bx, Ex						
V_{DD1}			—	1.2	2.0	mA
V_{DD2}			—	0.9	1.5	
Si8620Bx, Ex						
V_{DD1}			—	2.1	3.1	mA
V_{DD2}			—	1.6	2.4	
Si8621Bx, Ex						
V_{DD1}			—	1.9	2.9	mA
V_{DD2}			—	1.9	2.9	
Si8622Bx, Ex						
V_{DD1}			—	3.4	5.1	mA
V_{DD2}			—	4.2	6.2	
10 Mbps Supply Current (All Inputs = 5 MHz Square Wave, CI = 15 pF on All Outputs)						
Si8610Bx, Ex						
V_{DD1}			—	1.2	2.0	mA
V_{DD2}			—	1.0	1.8	
Si8620Bx, Ex						
V_{DD1}			—	2.1	3.1	mA
V_{DD2}			—	1.9	2.8	
Si8621Bx, Ex						
V_{DD1}			—	2.0	3.0	mA
V_{DD2}			—	2.0	3.0	
Si8622Bx, Ex						
V_{DD1}			—	3.5	5.3	mA
V_{DD2}			—	4.3	6.4	
100 Mbps Supply Current (All Inputs = 50 MHz Square Wave, CI = 15 pF on All Outputs)						
Si8610Bx, Ex						
V_{DD1}			—	1.2	2.0	mA
V_{DD2}			—	3.4	5.1	

Parameter	Symbol	Test Condition	Min	Typ	Max	Unit
Si8620Bx, Ex						
V_{DD1}			—	2.1	3.1	mA
V_{DD2}			—	6.3	8.8	
Si8621Bx, Ex						
V_{DD1}			—	4.4	6.1	mA
V_{DD2}			—	4.4	6.1	
Si8622Bx, Ex						
V_{DD1}			—	5.9	8.2	mA
V_{DD2}			—	6.6	9.3	
Timing Characteristics						
Si861x/2x Bx, Ex						
Maximum Data Rate			0	—	150	Mbps
Minimum Pulse Width			—	—	5.0	ns
Propagation Delay	t_{PHL}, t_{PLH}	See Figure 4.1 Propagation Delay Timing on page 13	5.0	8.0	13	ns
Pulse Width Distortion $ t_{PLH} - t_{PHL} $	PWD	See Figure 4.1 Propagation Delay Timing on page 13	—	0.2	4.5	ns
Propagation Delay Skew ³	$t_{PSK(P-P)}$		—	2.0	4.5	ns
Channel-Channel Skew	t_{PSK}		—	0.4	2.5	ns
All Models						
Output Rise Time	t_r	$C_L = 15\text{ pF}$ See Figure 4.1 Propagation Delay Timing on page 13	—	2.5	4.0	ns
Output Fall Time	t_f	$C_L = 15\text{ pF}$ See Figure 4.1 Propagation Delay Timing on page 13	—	2.5	4.0	ns
Peak Eye Diagram Jitter	$t_{JIT(PK)}$	See Figure 2.3 Eye Diagram on page 4	—	350	—	ps
Common Mode Transient Immunity Si86xxxB/C/D Si86xxxT	CMTI	$V_I = V_{DD}$ or 0 V $V_{CM} = 1500\text{ V}$ See Figure 4.2 Common-Mode Transient Immunity Test Circuit on page 13	35 60	50 100	— —	kV/ μ s
Start-up Time ⁴	t_{SU}		—	15	40	μ s

Parameter	Symbol	Test Condition	Min	Typ	Max	Unit
Note:						
1. $V_{DD1} = 3.3\text{ V} \pm 10\%$; $V_{DD2} = 3.3\text{ V} \pm 10\%$, $T_A = -40$ to $125\text{ }^\circ\text{C}$						
2. The nominal output impedance of an isolator driver channel is approximately $50\ \Omega$, $\pm 40\%$, which is a combination of the value of the on-chip series termination resistor and channel resistance of the output driver FET. When driving loads where transmission line effects will be a factor, output pins should be appropriately terminated with controlled-impedance PCB traces.						
3. $t_{PSK(P-P)}$ is the magnitude of the difference in propagation delay times measured between different units operating at the same supply voltages, load, and ambient temperature.						
4. Start-up time is the time period from the application of power to the appearance of valid data at the output.						

Table 4.4. Electrical Characteristics¹

Parameter	Symbol	Test Condition	Min	Typ	Max	Unit
VDD Undervoltage Threshold	V_{DDUV+}	V_{DD1} , V_{DD2} rising	1.95	2.24	2.375	V
VDD Undervoltage Threshold	V_{DDUV-}	V_{DD1} , V_{DD2} falling	1.88	2.16	2.325	V
VDD Undervoltage Hysteresis	V_{DDHYS}		50	70	95	mV
Positive-Going Input Threshold	V_{T+}	All inputs rising	1.6	—	1.9	V
Negative-Going Input Threshold	V_{T-}	All inputs falling	1.1	—	1.4	V
Input Hysteresis	V_{HYS}		0.40	0.45	0.50	V
High Level Input Voltage	V_{IH}		2.0	—	—	V
Low Level Input Voltage	V_{IL}		—	—	0.8	V
High Level Output Voltage	V_{OH}	$I_{OH} = -4\text{ mA}$	V_{DD1} , $V_{DD2} - 0.4$	2.3	—	V
Low Level Output Voltage	V_{OL}	$I_{OL} = 4\text{ mA}$	—	0.2	0.4	V
Input Leakage Current						
Si86xxxB/C/D	I_L		—	—	± 10	μA
Si86xxxT			—	—	± 15	
Output Impedance ²	Z_O		—	50	—	Ω
DC Supply Current (All Inputs 0 V or at Supply)						
Si8610Bx, Ex						
V_{DD1}		$V_I = 0(\text{Bx}), 1(\text{Ex})$	—	0.6	1.2	mA
V_{DD2}		$V_I = 0(\text{Bx}), 1(\text{Ex})$	—	0.8	1.5	
V_{DD1}		$V_I = 1(\text{Bx}), 0(\text{Ex})$	—	1.8	2.9	
V_{DD2}		$V_I = 1(\text{Bx}), 0(\text{Ex})$	—	0.8	1.5	
Si8620Bx, Ex						
V_{DD1}		$V_I = 0(\text{Bx}), 1(\text{Ex})$	—	0.8	1.4	mA
V_{DD2}		$V_I = 0(\text{Bx}), 1(\text{Ex})$	—	1.4	2.2	
V_{DD1}		$V_I = 1(\text{Bx}), 0(\text{Ex})$	—	3.3	5.3	
V_{DD2}		$V_I = 1(\text{Bx}), 0(\text{Ex})$	—	1.4	2.2	

Parameter	Symbol	Test Condition	Min	Typ	Max	Unit
Si8621Bx, Ex						
V_{DD1}		$V_I = 0(\text{Bx}), 1(\text{Ex})$	—	1.2	1.9	mA
V_{DD2}		$V_I = 0(\text{Bx}), 1(\text{Ex})$	—	1.2	1.9	
V_{DD1}		$V_I = 1(\text{Bx}), 0(\text{Ex})$	—	2.4	3.8	
V_{DD2}		$V_I = 1(\text{Bx}), 0(\text{Ex})$	—	2.4	3.8	
Si8622Bx, Ex						
V_{DD1}		$V_I = 0(\text{Bx}), 1(\text{Ex})$	—	2.6	4.2	mA
V_{DD2}		$V_I = 0(\text{Bx}), 1(\text{Ex})$	—	3.3	5.3	
V_{DD1}		$V_I = 1(\text{Bx}), 0(\text{Ex})$	—	4.0	6.4	
V_{DD2}		$V_I = 1(\text{Bx}), 0(\text{Ex})$	—	4.8	7.7	
1 Mbps Supply Current (All Inputs = 500 kHz Square Wave, CI = 15 pF on All Outputs)						
Si8610Bx, Ex						
V_{DD1}			—	1.2	2.0	mA
V_{DD2}			—	0.9	1.5	
Si8620Bx, Ex						
V_{DD1}			—	2.1	3.1	mA
V_{DD2}			—	1.6	2.4	
Si8621Bx, Ex						
V_{DD1}			—	1.9	2.9	mA
V_{DD2}			—	1.9	2.9	
Si8622Bx, Ex						
V_{DD1}			—	3.4	5.1	mA
V_{DD2}			—	4.2	6.2	
10 Mbps Supply Current (All Inputs = 5 MHz Square Wave, CI = 15 pF on All Outputs)						
Si8610Bx, Ex						
V_{DD1}			—	1.2	2.0	mA
V_{DD2}			—	1.0	1.6	
Si8620Bx, Ex						
V_{DD1}			—	2.1	3.1	mA
V_{DD2}			—	1.7	2.6	
Si8621Bx, Ex						
V_{DD1}			—	2.0	2.9	mA
V_{DD2}			—	2.0	2.9	

Parameter	Symbol	Test Condition	Min	Typ	Max	Unit
Si8622Bx, Ex						
V_{DD1}			—	3.5	5.2	mA
V_{DD2}			—	4.2	6.3	
100 Mbps Supply Current (All Inputs = 50 MHz Square Wave, CI = 15 pF on All Outputs)						
Si8610Bx, Ex						
V_{DD1}			—	1.2	2.0	mA
V_{DD2}			—	2.7	4.4	
Si8620Bx, Ex						
V_{DD1}			—	2.1	3.1	mA
V_{DD2}			—	5.1	7.1	
Si8621Bx, Ex						
V_{DD1}			—	3.7	5.2	mA
V_{DD2}			—	3.7	5.2	
Si8622Bx, Ex						
V_{DD1}			—	5.2	7.3	mA
V_{DD2}			—	6.0	8.4	
Timing Characteristics						
Si861x/2x Bx, Ex						
Maximum Data Rate			0	—	150	Mbps
Minimum Pulse Width			—	—	5.0	ns
Propagation Delay	t_{PHL}, t_{PLH}	See Figure 4.1 Propagation Delay Timing on page 13	5.0	8.0	14	ns
Pulse Width Distortion $ t_{PLH} - t_{PHL} $	PWD	See Figure 4.1 Propagation Delay Timing on page 13	—	0.2	5.0	ns
Propagation Delay Skew ³	$t_{PSK(P-P)}$		—	2.0	5.0	ns
Channel-Channel Skew	t_{PSK}		—	0.4	2.5	ns
All Models						
Output Rise Time	t_r	$C_L = 15$ pF See Figure 4.1 Propagation Delay Timing on page 13	—	2.5	4.0	ns
Output Fall Time	t_f	$C_L = 15$ pF See Figure 4.1 Propagation Delay Timing on page 13	—	2.5	4.0	ns
Peak Eye Diagram Jitter	$t_{JIT(PK)}$	See Figure 2.3 Eye Diagram on page 4	—	350	—	ps

Parameter	Symbol	Test Condition	Min	Typ	Max	Unit
Common Mode Transient Immunity Si86xxxB/C/D Si86xxxT	CMTI	$V_I = V_{DD}$ or 0 V $V_{CM} = 1500$ V See Figure 4.2 Common-Mode Transient Immunity Test Circuit on page 13	35 60	50 100	— —	kV/ μ s
Start-up Time ⁴	t_{SU}		—	15	40	μ s

Note:

- $V_{DD1} = 2.5$ V $\pm 5\%$; $V_{DD2} = 2.5$ V $\pm 5\%$, $T_A = -40$ to 125 °C
- The nominal output impedance of an isolator driver channel is approximately 50 Ω , $\pm 40\%$, which is a combination of the value of the on-chip series termination resistor and channel resistance of the output driver FET. When driving loads where transmission line effects will be a factor, output pins should be appropriately terminated with controlled-impedance PCB traces.
- $t_{PSK(P-P)}$ is the magnitude of the difference in propagation delay times measured between different units operating at the same supply voltages, load, and ambient temperature.
- Start-up time is the time period from the application of power to the appearance of valid data at the output.

Table 4.5. Regulatory Information^{1, 2, 3, 4}

For All Product Options Except Si86xxxT
CSA
The Si861x/2x is certified under CSA Component Acceptance Notice 5A. For more details, see File 232873.
61010-1: Up to 600 V _{RMS} reinforced insulation working voltage; up to 600 V _{RMS} basic insulation working voltage.
60950-1: Up to 600 V _{RMS} reinforced insulation working voltage; up to 1000 V _{RMS} basic insulation working voltage.
60601-1: Up to 125 V _{RMS} reinforced insulation working voltage; up to 380 V _{RMS} basic insulation working voltage.
VDE
The Si861x/2x is certified according to IEC 60747-5-5. For more details, see File 5006301-4880-0001.
60747-5-5: Up to 1200 V _{peak} for basic insulation working voltage.
60950-1: Up to 600 V _{RMS} reinforced insulation working voltage; up to 1000 V _{RMS} basic insulation working voltage.
UL
The Si861x/2x is certified under UL1577 component recognition program. For more details, see File E257455.
Rated up to 5000 V _{RMS} isolation voltage for basic protection.
CQC
The Si861x/2x is certified under GB4943.1-2011. For more details, see certificates CQC13001096110 and CQC13001096239.
Rated up to 600 V _{RMS} reinforced insulation working voltage; up to 1000 V _{RMS} basic insulation working voltage.
For All Si86xxxT Product Options
CSA
Certified under CSA Component Acceptance Notice 5A. For more details, see File 232873.
60950-1: Up to 600 V _{RMS} reinforced insulation working voltage; up to 1000 V _{RMS} basic insulation working voltage.
VDE
Certified according to VDE 0884-10.
UL
Certified under UL1577 component recognition program. For more details, see File E257455.
Rated up to 5000 V _{RMS} isolation voltage for basic protection.
CQC
Certified under GB4943.1-2011.
Rated up to 600 V _{RMS} reinforced insulation working voltage; up to 1000 V _{RMS} basic insulation working voltage.
Note:
<ol style="list-style-type: none"> 1. Regulatory Certifications apply to 2.5 kV_{RMS} rated devices, which are production tested to 3.0 kV_{RMS} for 1 s. 2. Regulatory Certifications apply to 3.75 kV_{RMS} rated devices, which are production tested to 4.5 kV_{RMS} for 1 s. 3. Regulatory Certifications apply to 5.0 kV_{RMS} rated devices, which are production tested to 6.0 kV_{RMS} for 1 s. 4. For more information, see 1. Ordering Guide.

Table 4.6. Insulation and Safety-Related Specifications

Parameter	Symbol	Test Condition	Value		Unit
			WB SOIC-16	NB SOIC-8	
Nominal Air Gap (Clearance) ¹	L(IO1)		8.0	4.9	mm
Nominal External Tracking ¹	L(IO2)		8.0	4.01	mm
Minimum Internal Gap (Internal Clearance)			0.014	0.014	mm
Tracking Resistance (Proof Tracking Index)	PTI	IEC60112	600	600	V _{RMS}
Erosion Depth	ED		0.019	0.019	mm
Resistance (Input-Output) ²	R _{IO}		10 ¹²	10 ¹²	W
Capacitance (Input-Output) ²	C _{IO}	f = 1 MHz	2.0	2.0	pF
Input Capacitance ³	C _I		4.0	4.0	pF

Note:

- The values in this table correspond to the nominal creepage and clearance values. VDE certifies the clearance and creepage limits as 4.7 mm minimum for the NB SOIC-16 package and 8.5 mm minimum for the WB SOIC-16 package. UL does not impose a clearance and creepage minimum for component-level certifications. CSA certifies the clearance and creepage limits as 3.9 mm minimum for the NB SOIC-16 and 7.6 mm minimum for the WB SOIC-16 package.
- To determine resistance and capacitance, the Si86xx is converted into a 2-terminal device. Pins 1–8 (1–4 on NB SOIC-8) are shorted together to form the first terminal, and pins 9–16 (5–8 on NB SOIC-8) are shorted together to form the second terminal. The parameters are then measured between these two terminals.
- Measured from input pin to ground.

Table 4.7. IEC 60664-1 Ratings

Parameter	Test Conditions	Specification	
		WB SOIC-16	NB SOIC-8
Basic Isolation Group	Material Group	I	I
Installation Classification	Rated Mains Voltages ≤ 150 V _{RMS}	I-IV	I-IV
	Rated Mains Voltages ≤ 300 V _{RMS}	I-IV	I-III
	Rated Mains Voltages ≤ 400 V _{RMS}	I-III	I-II
	Rated Mains Voltages ≤ 600 V _{RMS}	I-III	I-II

Table 4.8. IEC 60747-5-5 Insulation Characteristics for Si86xxxx¹

Parameter	Symbol	Test Condition	Characteristic		Unit
			WB SOIC-16	NB SOIC-8	
Maximum Working Insulation Voltage	V _{IORM}		1200	630	V _{peak}
Input to Output Test Voltage	V _{PR}	Method b1 (V _{IORM} × 1.875 = V _{PR} , 100% Production Test, t _m = 1 sec, Partial Discharge < 5 pC)	2250	1182	V _{peak}
Transient Overvoltage	V _{IOTM}	t = 60 sec	6000	6000	V _{peak}
Surge Voltage	V _{IOSM}	Tested per IEC 60065 with surge voltage of 1.2 μs/50 μs Si86xxxT tested with magnitude 6250 V × 1.6 = 10 kV Si86xxxB/C/D tested with 4000 V	6250	—	V _{peak}
			4000	4000	
Pollution Degree (DIN VDE 0110, Table 1)			2	2	
Insulation Resistance at T _S , V _{IO} = 500 V	R _S		>10 ⁹	>10 ⁹	Ω

Note:
1. Maintenance of the safety data is ensured by protective circuits. The Si86xxxx provides a climate classification of 40/125/21.

Table 4.9. IEC Safety Limiting Values¹

Parameter	Symbol	Test Condition	Max		Unit
			WB SOIC-16	NB SOIC-8	
Case Temperature	T _S		150	150	°C
Safety Input, Output, or Supply Current	I _S	θ _{JA} = 140 °C/W (NB SOIC-8) 100 °C/W (WB SOIC-16) V _I = 5.5 V, T _J = 150 °C, T _A = 25 °C	220	160	mA
Device Power Dissipation ²	P _D		150	150	mW

Note:
1. Maximum value allowed in the event of a failure; also see the thermal derating curve in [Figure 4.3 \(WB SOIC-16\) Thermal Derating Curve, Dependence of Safety Limiting Values with Case Temperature per DIN EN 60747-5-5/VDE 0884-10, as Applies on page 24](#) and [Figure 4.4 \(NB SOIC-8\) Thermal Derating Curve, Dependence of Safety Limiting Values with Case Temperature per DIN EN 60747-5-5/VDE 0884-10, as Applies on page 24](#).
2. The Si86xx is tested with VDD1 = VDD2 = 5.5 V; T_J = 150 °C; C_L = 15 pF, input a 150 Mbps 50% duty cycle square wave.

Table 4.10. Thermal Characteristics

Parameter	Symbol	WB SOIC-16	NB SOIC-8	Unit
IC Junction-to-Air Thermal Resistance	θ_{JA}	100	140	$^{\circ}\text{C}/\text{W}$

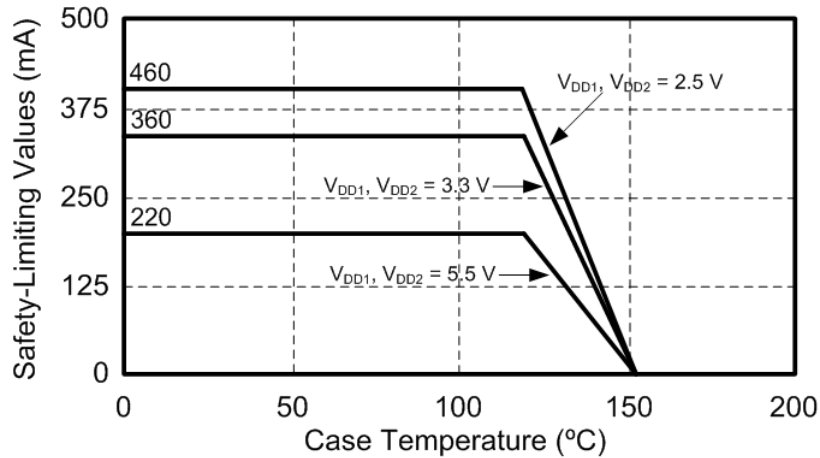

Figure 4.3. (WB SOIC-16) Thermal Derating Curve, Dependence of Safety Limiting Values with Case Temperature per DIN EN 60747-5-5/VDE 0884-10, as Applies

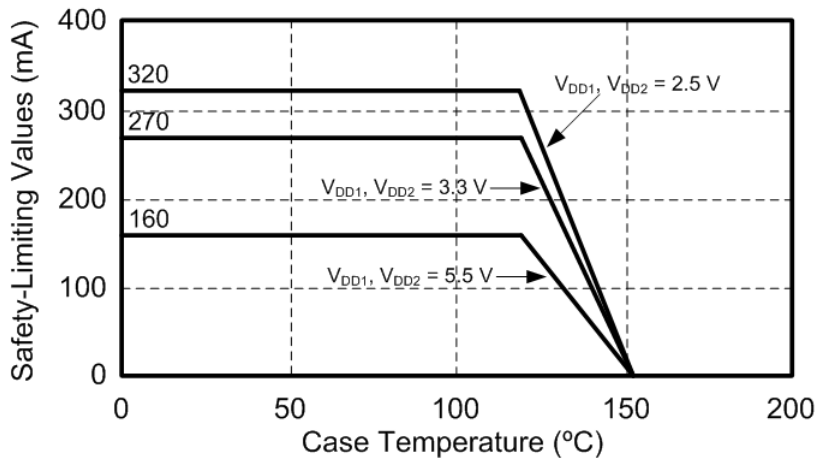

Figure 4.4. (NB SOIC-8) Thermal Derating Curve, Dependence of Safety Limiting Values with Case Temperature per DIN EN 60747-5-5/VDE 0884-10, as Applies