



Chipsmall Limited consists of a professional team with an average of over 10 year of expertise in the distribution of electronic components. Based in Hongkong, we have already established firm and mutual-benefit business relationships with customers from,Europe,America and south Asia,supplying obsolete and hard-to-find components to meet their specific needs.

With the principle of "Quality Parts,Customers Priority,Honest Operation,and Considerate Service",our business mainly focus on the distribution of electronic components. Line cards we deal with include Microchip,ALPS,ROHM,Xilinx,Pulse,ON,Everlight and Freescale. Main products comprise IC,Modules,Potentiometer,IC Socket,Relay,Connector.Our parts cover such applications as commercial,industrial, and automotives areas.

We are looking forward to setting up business relationship with you and hope to provide you with the best service and solution. Let us make a better world for our industry!



Contact us

Tel: +86-755-8981 8866 Fax: +86-755-8427 6832

Email & Skype: info@chipsmall.com Web: www.chipsmall.com

Address: A1208, Overseas Decoration Building, #122 Zhenhua RD., Futian, Shenzhen, China





Si8650/51/52/55 Data Sheet

Low Power Five-Channel Digital Isolator

Silicon Lab's family of ultra-low-power digital isolators are CMOS devices offering substantial data rate, propagation delay, power, size, reliability, and external BOM advantages over legacy isolation technologies. The operating parameters of these products remain stable across wide temperature ranges and throughout device service life for ease of design and highly uniform performance. All device versions have Schmitt trigger inputs for high noise immunity and only require VDD bypass capacitors.

Data rates up to 150 Mbps are supported, and all devices achieve propagation delays of less than 10 ns. Enable inputs provide a single point control for enabling and disabling output drive. Ordering options include a choice of isolation ratings (2.5, 3.75 and 5 kV) and a selectable fail-safe operating mode to control the default output state during power loss. All products >1 kV_{RMS} are safety certified by UL, CSA, VDE, and CQC, and products in wide-body packages support reinforced insulation withstanding up to 5 kV_{RMS}.

Applications

- Industrial automation systems
- Medical electronics
- Hybrid electric vehicles
- Isolated switch mode supplies
- Isolated ADC, DAC
- Motor control
- Power inverters
- Communication systems

Safety Regulatory Approvals

- UL 1577 recognized
 - Up to 5000 V_{RMS} for 1 minute
- CSA component notice 5A approval
 - IEC 60950-1, 61010-1, 60601-1 (reinforced insulation)
- VDE certification conformity
 - IEC 60747-5-2 (VDE0884 Part 2)
 - EN60950-1 (reinforced insulation)
- CQC certification approval
 - GB4943.1

KEY FEATURES

- High-speed operation
 - DC to 150 Mbps
- No start-up initialization required
- Wide Operating Supply Voltage
 - 2.5–5.5 V
- Up to 5000 V_{RMS} isolation
- 60-year life at rated working voltage
- High electromagnetic immunity
- Ultra low power (typical)
 - 5 V Operation
 - 1.6 mA per channel at 1 Mbps
 - 5.5 mA per channel at 100 Mbps
 - 2.5 V Operation
 - 1.5 mA per channel at 1 Mbps
 - 3.5 mA per channel at 100 Mbps
- Tri-state outputs with ENABLE
- Schmitt trigger inputs
- Selectable fail-safe mode
 - Default high or low output (ordering option)
- Precise timing (typical)
 - 10 ns propagation delay
 - 1.5 ns pulse width distortion
 - 0.5 ns channel-channel skew
 - 2 ns propagation delay skew
 - 5 ns minimum pulse width
- Transient Immunity 50 kV/μs
- AEC-Q100 qualification
- Wide temperature range
 - –40 to 125 °C
- RoHS-compliant packages
 - SOIC-16 wide body
 - SOIC-16 narrow body
 - QSOP-16

1. Feature List

- High-speed operation
 - DC to 150 Mbps
- No start-up initialization required
- Wide Operating Supply Voltage
 - 2.5–5.5 V
- Up to 5000 V_{RMS} isolation
- 60-year life at rated working voltage
- High electromagnetic immunity
- Ultra low power (typical)
 - 5 V Operation
 - 1.6 mA per channel at 1 Mbps
 - 5.5 mA per channel at 100 Mbps
 - 2.5 V Operation
 - 1.5 mA per channel at 1 Mbps
 - 3.5 mA per channel at 100 Mbps
- Tri-state outputs with ENABLE
- Schmitt trigger inputs
- Selectable fail-safe mode
 - Default high or low output (ordering option)
- Precise timing (typical)
 - 10 ns propagation delay
 - 1.5 ns pulse width distortion
 - 0.5 ns channel-channel skew
 - 2 ns propagation delay skew
 - 5 ns minimum pulse width
- Transient Immunity 50 kV/ μ s
- AEC-Q100 qualification
- Wide temperature range
 - –40 to 125 °C
- RoHS-compliant packages
 - SOIC-16 wide body
 - SOIC-16 narrow body
 - QSOP-16

2. Ordering Guide

Table 2.1. Ordering Guide for Valid OPNs^{1,2}

Ordering Part Number (OPN)	Number of Inputs VDD1 Side	Number of Inputs VDD2 Side	Max Data Rate (Mbps)	Default Output State	Isolation rating (kV)	Temp (°C)	Package
Si8650BB-B-IS1	5	0	150	Low	2.5	–40 to 125 °C	NB SOIC-16
Si8650EC-B-IS1	5	0	150	High	3.75	–40 to 125 °C	NB SOIC-16
Si8650BD-B-IS	5	0	150	Low	5.0	–40 to 125 °C	WB SOIC-16
Si8650ED-B-IS	5	0	150	High	5.0	–40 to 125 °C	WB SOIC-16
Si8651BB-B-IS1	4	1	150	Low	2.5	–40 to 125 °C	NB SOIC-16
Si8651BC-B-IS1	4	1	150	Low	3.75	–40 to 125 °C	NB SOIC-16
Si8651EC-B-IS1	4	1	150	High	3.75	–40 to 125 °C	NB SOIC-16
Si8651BD-B-IS	4	1	150	Low	5.0	–40 to 125 °C	WB SOIC-16
Si8651ED-B-IS	4	1	150	High	5.0	–40 to 125 °C	WB SOIC-16
Si8652BB-B-IS1	3	2	150	Low	2.5	–40 to 125 °C	NB SOIC-16
Si8652BC-B-IS1	3	2	150	Low	3.75	–40 to 125 °C	NB SOIC-16
Si8652EC-B-IS1	3	2	150	High	3.75	–40 to 125 °C	NB SOIC-16
Si8652BD-B-IS	3	2	150	Low	5.0	–40 to 125 °C	WB SOIC-16
Si8652ED-B-IS	3	2	150	High	5.0	–40 to 125 °C	WB SOIC-16
Si8655BA-B-IU	5	0	150	Low	1.0	–40 to 125 °C	QSOP-16
Si8655BA-C-IU	5	0	150	Low	1.0	–40 to 125 °C	QSOP-16
Si8655BA-B-IS	5	0	150	Low	1.0	–40 to 125 °C	WB SOIC-16
Si8655BB-B-IS1	5	0	150	Low	2.5	–40 to 125 °C	NB SOIC-16
Si8655BD-B-IS	5	0	150	Low	5.0	–40 to 125 °C	WB SOIC-16

Notes:

1. All packages are RoHS-compliant with peak reflow temperatures of 260 °C according to the JEDEC industry standard classifications and peak solder temperatures.
2. “Si” and “SI” are used interchangeably.
3. An “R” at the end of the part number denotes tape and reel packaging option.

3. Functional Description

3.1 Theory of Operation

The operation of an Si865x channel is analogous to that of an opto coupler, except an RF carrier is modulated instead of light. This simple architecture provides a robust isolated data path and requires no special considerations or initialization at start-up. A simplified block diagram for a single Si865x channel is shown in the figure below.

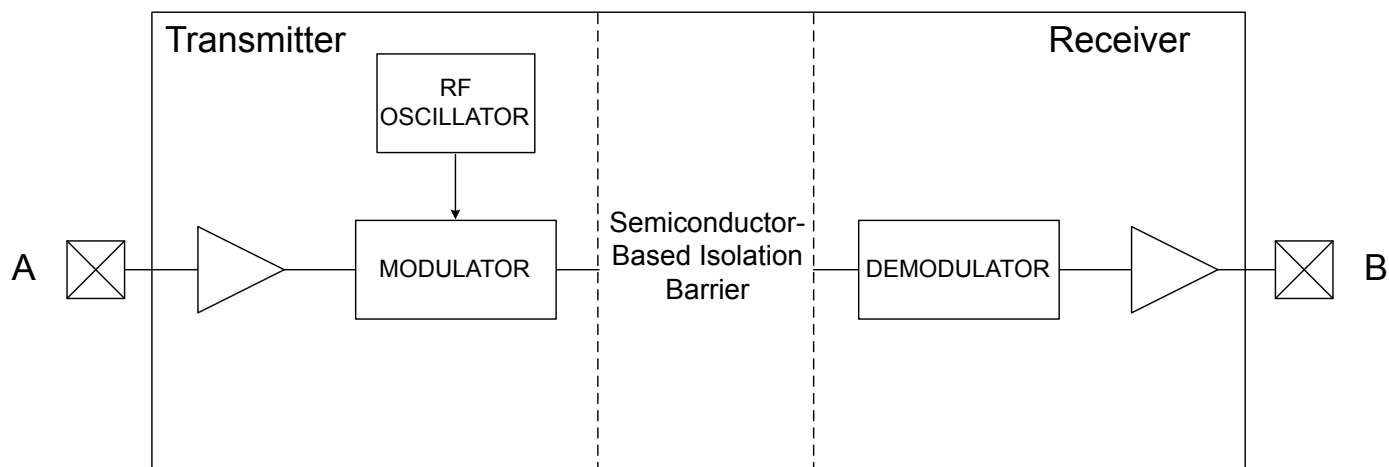

Figure 3.1. Simplified Channel Diagram

A channel consists of an RF Transmitter and RF Receiver separated by a semiconductor-based isolation barrier. Referring to the Transmitter, input A modulates the carrier provided by an RF oscillator using on/off keying. The Receiver contains a demodulator that decodes the input state according to its RF energy content and applies the result to output B via the output driver. This RF on/off keying scheme is superior to pulse code schemes as it provides best-in-class noise immunity, low power consumption, and better immunity to magnetic fields. See the figure below for more details.

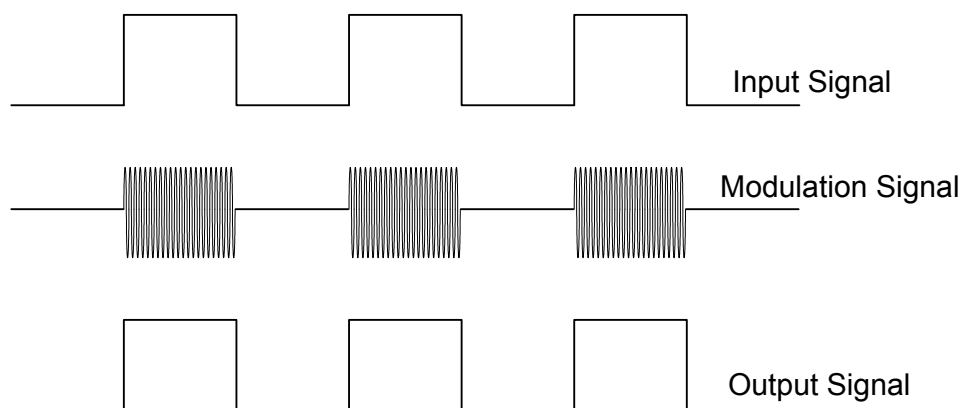

Figure 3.2. Modulation Scheme

3.2 Eye Diagram

The figure below illustrates an eye-diagram taken on an Si8650. For the data source, the test used an Anritsu (MP1763C) Pulse Pattern Generator set to 1000 ns/div. The output of the generator's clock and data from an Si8650 were captured on an oscilloscope. The results illustrate that data integrity was maintained even at the high data rate of 150 Mbps. The results also show that 2 ns pulse width distortion and 350 ps peak jitter were exhibited.

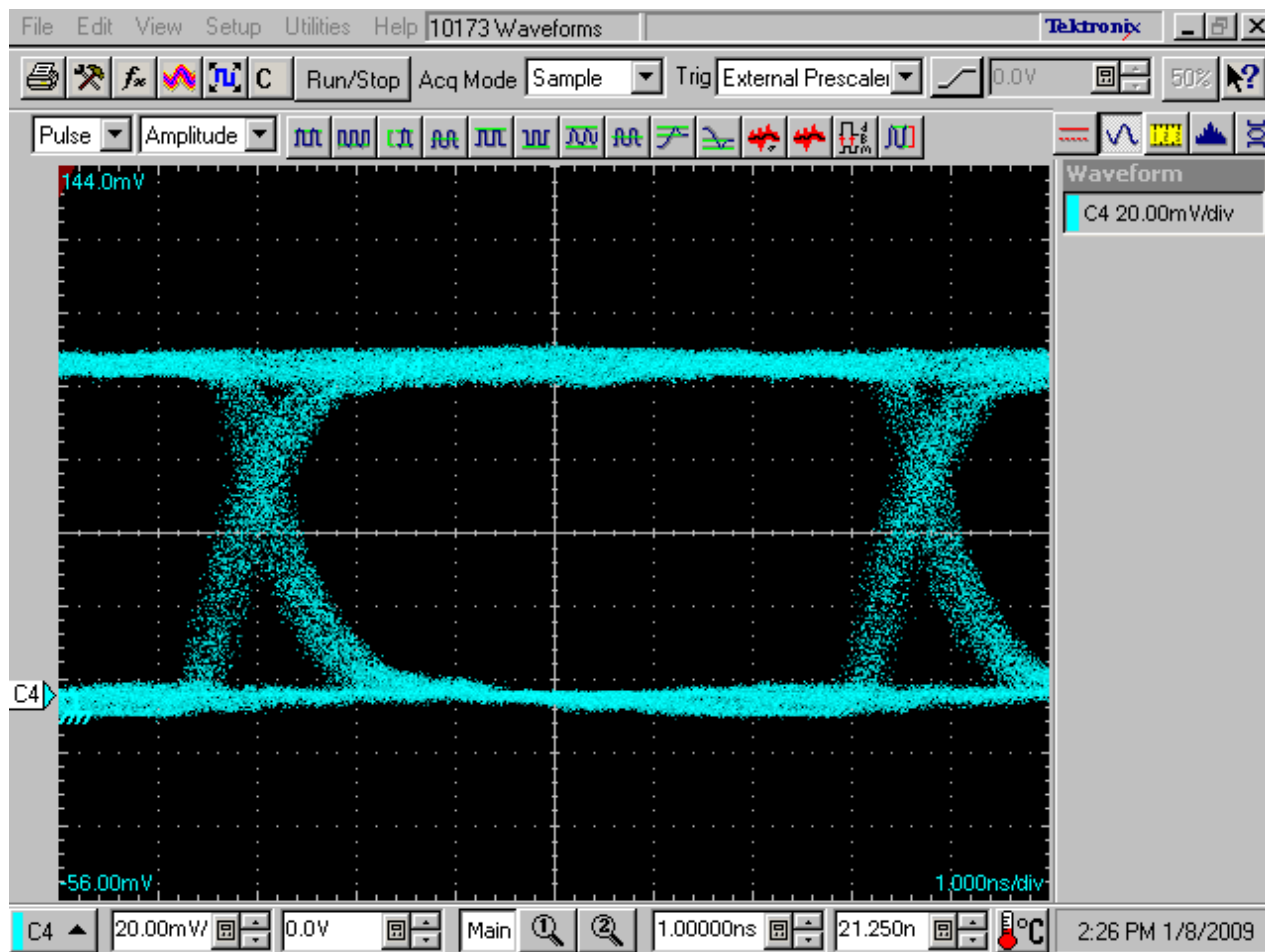

Figure 3.3. Eye Diagram

4. Device Operation

Device behavior during start-up, normal operation, and shutdown is shown in [Figure 4.1 Device Behavior during Normal Operation on page 7](#), where UVLO+ and UVLO- are the positive-going and negative-going thresholds respectively. Refer to the table below to determine outputs when power supply (VDD) is not present. Additionally, refer to the table on the following page for logic conditions when enable pins are used.

Table 4.1. Si865x Logic Operation

V _I Input ^{1,2}	EN Input ^{1,2,3,4}	VDDI State ^{1,5,6}	VDDO State ^{1,5,6}	V _O Output ^{1,2}	Comments
H	H or NC	P	P	H	Enabled, normal operation.
L	H or NC	P	P	L	
X ⁷	L	P	P	Hi-Z ⁸	Disabled.
X ⁷	H or NC	UP	P	L ⁹ H ⁹	Upon transition of VDDI from unpowered to powered, V _O returns to the same state as V _I in less than 1 μs.
X ⁷	L	UP	P	Hi-Z ⁸	Disabled.
X ⁷	X ⁷	P	UP	Undetermined	Upon transition of VDDO from unpowered to powered, V _O returns to the same state as V _I within 1 μs, if EN is in either the H or NC state. Upon transition of VDDO from unpowered to powered, V _O returns to Hi-Z within 1 μs if EN is L.

Notes:

- VDDI and VDDO are the input and output power supplies. V_I and V_O are the respective input and output terminals. EN is the enable control input located on the same output side.
- X = not applicable; H = Logic High; L = Logic Low; Hi-Z = High Impedance.
- It is recommended that the enable inputs be connected to an external logic high or low level when the Si865x is operating in noisy environments.
- No Connect (NC) replaces EN1 on Si8650. No Connects are not internally connected and can be left floating, tied to VDD, or tied to GND.
- “Powered” state (P) is defined as 2.5 V < VDD < 5.5 V.
- “Unpowered” state (UP) is defined as VDD = 0 V.
- Note that an I/O can power the die for a given side through an internal diode if its source has adequate current.
- When using the enable pin (EN) function, the output pin state is driven into a high-impedance state when the EN pin is disabled (EN = 0).
- See [2. Ordering Guide](#) for details. This is the selectable fail-safe operating mode (ordering option). Some devices have default output state = H, and some have default output state = L, depending on the ordering part number (OPN). For default high devices, the data channels have pull-ups on inputs/outputs. For default low devices, the data channels have pull-downs on inputs/outputs.

Table 4.2. Enable Input Truth ¹

P/N	EN1 ^{1,2}	EN2 ^{1,2}	Operation
Si8650	—	H	Outputs B1, B2, B3, B4, B5 are enabled and follow input state.
	—	L	Outputs B1, B2, B3, B4, B5 are disabled and Logic Low or in high impedance state. ³
Si8651	H	X	Output A5 enabled and follow input state.
	L	X	Output A5 disabled and in high impedance state. ³
	X	H	Outputs B1, B2, B3, B4 are enabled and follow input state.
	X	L	Outputs B1, B2, B3, B4 are disabled and in high impedance state. ³
Si8652	H	X	Outputs A4 and A5 are enabled and follow input state.
	L	X	Outputs A4 and A5 are disabled and in high impedance state. ³
	X	H	Outputs B1, B2, B3 are enabled and follow input state.
	X	L	Outputs B1, B2, B3 are disabled and in high impedance state. ³
Si8655	—	—	Outputs B1, B2, B3, B4, B5 are enabled and follow input state.

Notes:

1. Enable inputs EN1 and EN2 can be used for multiplexing, for clock sync, or other output control. These inputs are internally pulled-up to local VDD by a 2 μ A current source allowing them to be connected to an external logic level (high or low) or left floating. To minimize noise coupling, do not connect circuit traces to EN1 or EN2 if they are left floating. If EN1, EN2 are unused, it is recommended they be connected to an external logic level, especially if the Si865x is operating in a noisy environment.
2. X = not applicable; H = Logic High; L = Logic Low.
3. When using the enable pin (EN) function, the output pin state is driven into a high-impedance state when the EN pin is disabled (EN = 0).

4.1 Device Startup

Outputs are held low during powerup until VDD is above the UVLO threshold for time period tSTART. Following this, the outputs follow the states of inputs.

4.2 Undervoltage Lockout

Undervoltage Lockout (UVLO) is provided to prevent erroneous operation during device startup and shutdown or when VDD is below its specified operating circuits range. Both Side A and Side B each have their own undervoltage lockout monitors. Each side can enter or exit UVLO independently. For example, Side A unconditionally enters UVLO when V_{DD1} falls below $V_{DD1(UVLO-)}$ and exits UVLO when V_{DD1} rises above $V_{DD1(UVLO+)}$. Side B operates the same as Side A with respect to its V_{DD2} supply.

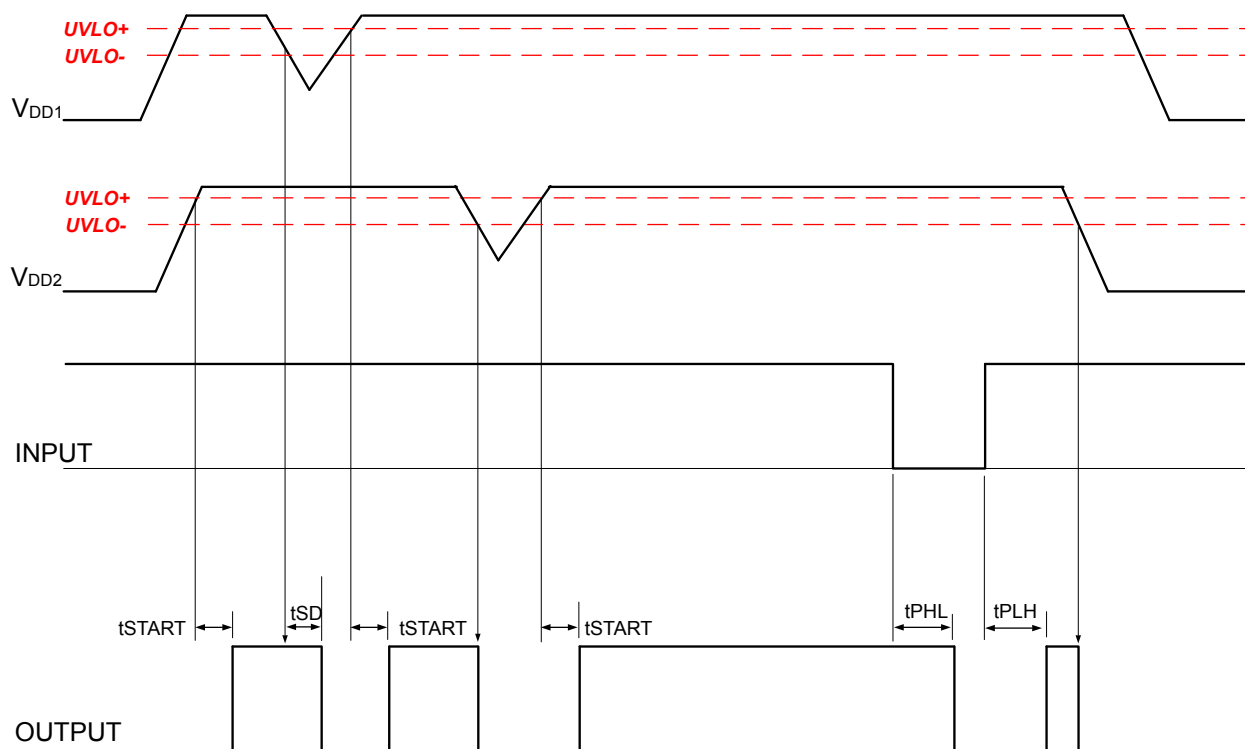

Figure 4.1. Device Behavior during Normal Operation

4.3 Layout Recommendations

To ensure safety in the end user application, high voltage circuits (i.e., circuits with $>30 V_{AC}$) must be physically separated from the safety extra-low voltage circuits (SELV is a circuit with $<30 V_{AC}$) by a certain distance (creepage/clearance). If a component, such as a digital isolator, straddles this isolation barrier, it must meet those creepage/clearance requirements and also provide a sufficiently large high-voltage breakdown protection rating (commonly referred to as working voltage protection). [Table 5.5 Regulatory Information¹ on page 20](#) and [Table 5.6 Insulation and Safety-Related Specifications on page 21](#) detail the working voltage and creepage/clearance capabilities of the Si86xx. These tables also detail the component standards (UL1577, IEC60747, CSA 5A), which are readily accepted by certification bodies to provide proof for end-system specifications requirements. Refer to the end-system specification (61010-1, 60950-1, 60601-1, etc.) requirements before starting any design that uses a digital isolator.

4.3.1 Supply Bypass

The Si865x family requires a $0.1 \mu F$ bypass capacitor between V_{DD1} and GND1 and V_{DD2} and GND2. The capacitor should be placed as close as possible to the package. To enhance the robustness of a design, the user may also include resistors ($50\text{--}300 \Omega$) in series with the inputs and outputs if the system is excessively noisy.

4.3.2 Output Pin Termination

The nominal output impedance of an isolator driver channel is approximately 50Ω , $\pm 40\%$, which is a combination of the value of the on-chip series termination resistor and channel resistance of the output driver FET. When driving loads where transmission line effects will be a factor, output pins should be appropriately terminated with controlled impedance PCB traces.

4.4 Fail-Safe Operating Mode

Si86xx devices feature a selectable (by ordering option) mode whereby the default output state (when the input supply is unpowered) can either be a logic high or logic low when the output supply is powered. See [Table 4.1 Si865x Logic Operation on page 5](#) and [2. Ordering Guide](#) for more information.

4.5 Typical Performance Characteristics

The typical performance characteristics depicted in the following diagrams are for information purposes only. Refer to [Table 5.2 Electrical Characteristics on page 10](#) through [Table 5.4 Electrical Characteristics on page 17](#) for actual specification limits.

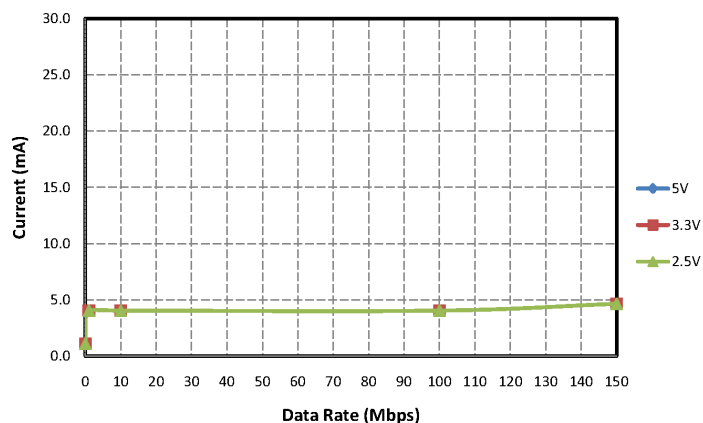

Figure 4.2. Si8650/55 Typical V_{DD1} Supply Current vs. Data Rate 5, 3.3, and 2.5 V Operation

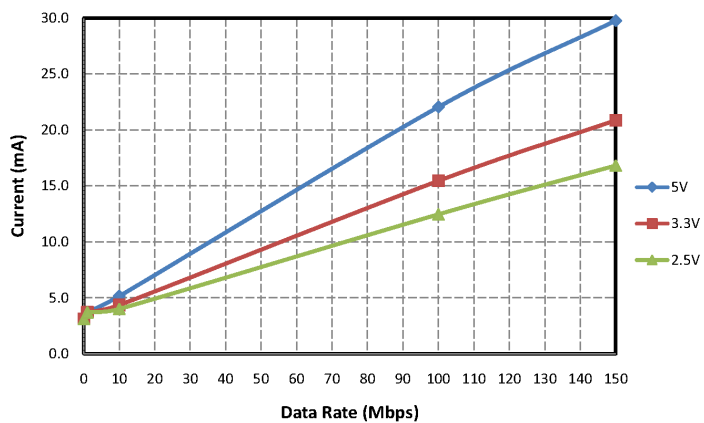

Figure 4.3. Si8650/55 Typical V_{DD2} Supply Current vs. Data Rate 5, 3.3, and 2.5 V Operation (15 pF Load)

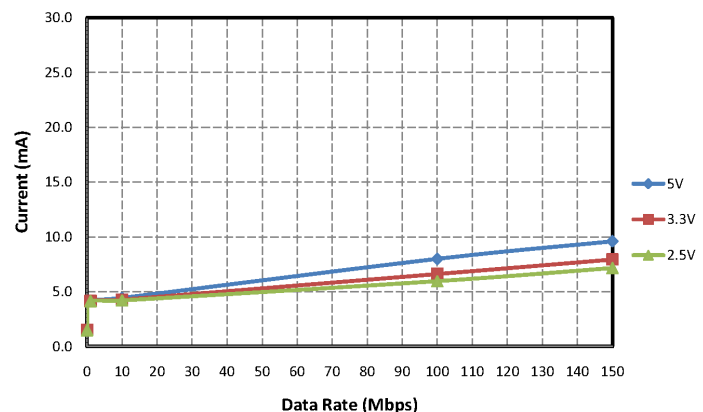

Figure 4.4. Si8651 Typical V_{DD1} Supply Current vs. Data Rate 5, 3.3, and 2.5 V Operation (15 pF Load)

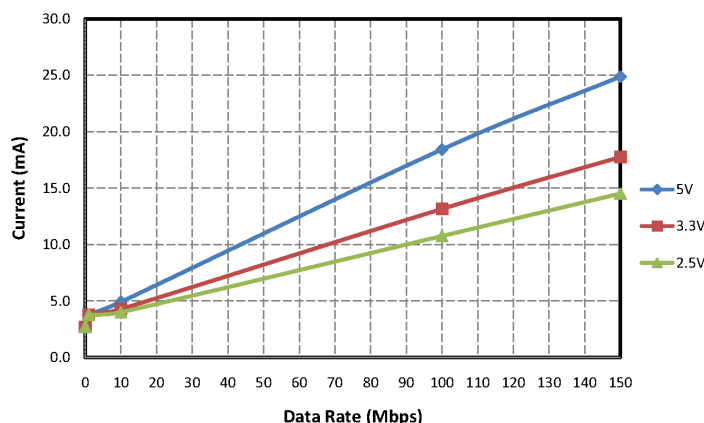

Figure 4.5. Si8651 Typical V_{DD2} Supply Current vs. Data Rate 5, 3.3, and 2.5 V Operation (15 pF Load)

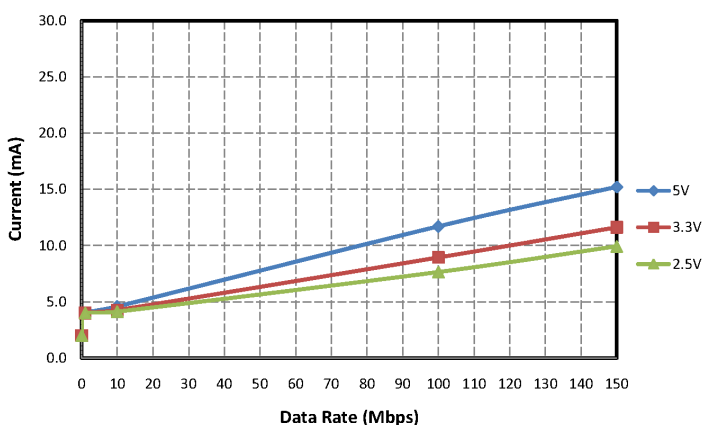

Figure 4.6. Si8652 Typical V_{DD1} Supply Current vs. Data Rate 5, 3.3, and 2.5 V Operation (15 pF Load)

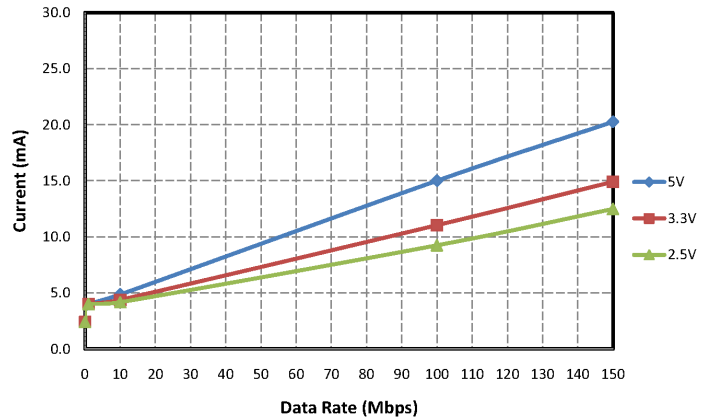

Figure 4.7. Si8652 Typical V_{DD2} Supply Current vs. Data Rate 5, 3.3, and 2.5 V Operation (15 pF Load)

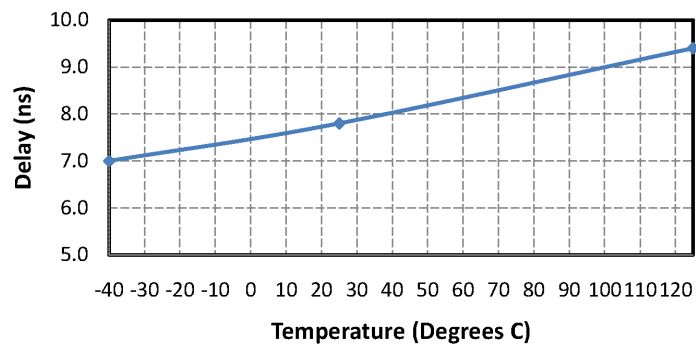

Figure 4.8. Propagation Delay vs. Temperature

5. Electrical Specifications

Table 5.1. Recommended Operating Conditions

Parameter	Symbol	Min	Typ	Max	Unit
Ambient Operating Temperature ¹	T_A	-40	25	125	°C
Supply Voltage	V_{DD1}	2.5	—	5.5	V
	V_{DD2}	2.5	—	5.5	V

Note:
1. The maximum ambient temperature is dependent on data frequency, output loading, number of operating channels, and supply voltage.

Table 5.2. Electrical Characteristics

($V_{DD1} = 5 V \pm 10\%$, $V_{DD2} = 5 V \pm 10\%$, $T_A = -40$ to 125 °C)

Parameter	Symbol	Test Condition	Min	Typ	Max	Unit
VDD Undervoltage Threshold	V_{DDUV+}	V_{DD1}, V_{DD2} rising	1.95	2.24	2.375	V
VDD Undervoltage Threshold	V_{DDUV-}	V_{DD1}, V_{DD2} falling	1.88	2.16	2.325	V
VDD Undervoltage Hysteresis	V_{DDHYS}		50	70	95	mV
Positive-Going Input Threshold	V_{T+}	All inputs rising	1.4	1.67	1.9	V
Negative-Going Input Threshold	V_{T-}	All inputs falling	1.0	1.23	1.4	V
Input Hysteresis	V_{HYS}		0.38	0.44	0.50	V
High Level Input Voltage	V_{IH}		2.0	—	—	V
Low Level input voltage	V_{IL}		—	—	0.8	V
High Level Output Voltage	V_{OH}	$I_{OH} = -4$ mA	$V_{DD1}, V_{DD2} - 0.4$	4.8	—	V
Low Level Output Voltage	V_{OL}	$I_{OL} = 4$ mA	—	0.2	0.4	V
Input Leakage Current	I_L		—	—	± 10	μA
Output Impedance ¹	Z_O		—	50	—	Ω
Enable Input High Current	I_{ENH}	$V_{ENx} = V_{IH}$	—	2.0	—	μA
Enable Input Low Current	I_{ENL}	$V_{ENx} = V_{IL}$	—	2.0	—	μA
DC Supply Current (All inputs 0 V or at Supply)						
Si8650Bx, Ex, Si8655Bx						
V_{DD1}		$V_I = 0(Bx), 1(Ex)$	—	1.1	1.8	mA
V_{DD2}		$V_I = 0(Bx), 1(Ex)$	—	3.1	4.7	
V_{DD1}		$V_I = 1(Bx), 0(Ex)$	—	7.0	9.8	
V_{DD2}		$V_I = 1(Bx), 0(Ex)$	—	3.3	5.0	

Parameter	Symbol	Test Condition	Min	Typ	Max	Unit
Si8651Bx, Ex						
V _{DD1}		V _I = 0(Bx), 1(Ex)	—	1.5	2.4	mA
V _{DD2}		V _I = 0(Bx), 1(Ex)	—	2.7	4.1	
V _{DD1}		V _I = 1(Bx), 0(Ex)	—	6.6	9.2	
V _{DD2}		V _I = 1(Bx), 0(Ex)	—	4.0	6.0	
Si8652Bx, Ex						
V _{DD1}		V _I = 0(Bx), 1(Ex)	—	2.0	3.0	mA
V _{DD2}		V _I = 0(Bx), 1(Ex)	—	2.4	3.6	
V _{DD1}		V _I = 1(Bx), 0(Ex)	—	5.6	7.8	
V _{DD2}		V _I = 1(Bx), 0(Ex)	—	5.0	7.5	
1 Mbps Supply Current (All inputs = 500 kHz square wave, CI = 15 pF on all outputs)						
Si8650Bx, Ex, Si8655Bx						
V _{DD1}			—	4.1	5.7	mA
V _{DD2}			—	3.7	5.2	
Si8651Bx, Ex						
V _{DD1}			—	4.2	5.8	mA
V _{DD2}			—	3.8	5.3	
Si8652Bx, Ex						
V _{DD1}			—	4.0	5.6	mA
V _{DD2}			—	4.0	5.6	
10 Mbps Supply Current (All inputs = 5 MHz square wave, CI = 15 pF on all outputs)						
Si8650Bx, Ex, Si8655Bx						
V _{DD1}			—	4.1	5.7	mA
V _{DD2}			—	5.2	7.2	
Si8651Bx, Ex						
V _{DD1}			—	4.4	6.2	mA
V _{DD2}			—	4.9	6.9	
Si8652Bx, Ex						
V _{DD1}			—	4.6	6.4	mA
V _{DD2}			—	4.9	6.8	
100 Mbps Supply Current (All inputs = 50 MHz square wave, CI = 15 pF on all outputs)						
Si8650Bx, Ex, Si8655Bx						
V _{DD1}			—	4.1	5.7	mA
V _{DD2}			—	22.1	28.7	
Si8651Bx, Ex						

Parameter	Symbol	Test Condition	Min	Typ	Max	Unit
V_{DD1}			—	8.0	10.8	mA
V_{DD2}			—	18.4	24	
Si8652Bx, Ex						
V_{DD1}			—	11.7	15.2	mA
V_{DD2}			—	15	19.5	
Timing Characteristics						
Si865xBx, Ex						
Maximum Data Rate			0	—	150	Mbps
Minimum Pulse Width			—	—	5.0	ns
Propagation Delay	t_{PHL}, t_{PLH}	See Figure 5.2 Propagation Delay Timing on page 13	5.0	8.0	13	ns
Pulse Width Distortion $ t_{PLH} - t_{PHL} $	PWD	See Figure 5.2 Propagation Delay Timing on page 13	—	0.2	4.5	ns
Propagation Delay Skew ²	$t_{PSK(P-P)}$		—	2.0	4.5	ns
Channel-Channel Skew	t_{PSK}		—	0.4	2.5	ns
All Models						
Output Rise Time	t_r	$C_L = 15 \text{ pF}$ See Figure 5.2 Propagation Delay Timing on page 13	—	2.5	4.0	ns
Output Fall Time	t_f	$C_L = 15 \text{ pF}$ See Figure 5.2 Propagation Delay Timing on page 13	—	2.5	4.0	ns
Peak eye diagram jitter	$t_{JIT(PK)}$	See Figure 3.3 Eye Diagram on page 4	—	350	—	ps
Common Mode Transient Immunity	CMTI	$V_I = V_{DD} \text{ or } 0 \text{ V}$ $V_{CM} = 1500 \text{ V}$ (see Figure 5.3 Common Mode Transient Immunity Test Circuit on page 14)	35	50	—	kV/ μ s
Enable to Data Valid	t_{en1}	See Figure 5.1 ENABLE Timing Diagram on page 13	—	6.0	11	ns
Enable to Data Tri-State	t_{en2}	See Figure 5.1 ENABLE Timing Diagram on page 13	—	8.0	12	ns
Start-up Time ³	t_{SU}		—	15	40	μ s
Notes:						
1. The nominal output impedance of an isolator driver channel is approximately 50Ω , $\pm 40\%$, which is a combination of the value of the on-chip series termination resistor and channel resistance of the output driver FET. When driving loads where transmission line effects will be a factor, output pins should be appropriately terminated with controlled impedance PCB traces.						
2. $t_{PSK(P-P)}$ is the magnitude of the difference in propagation delay times measured between different units operating at the same supply voltages, load, and ambient temperature.						
3. Start-up time is the time period from the application of power to valid data at the output.						

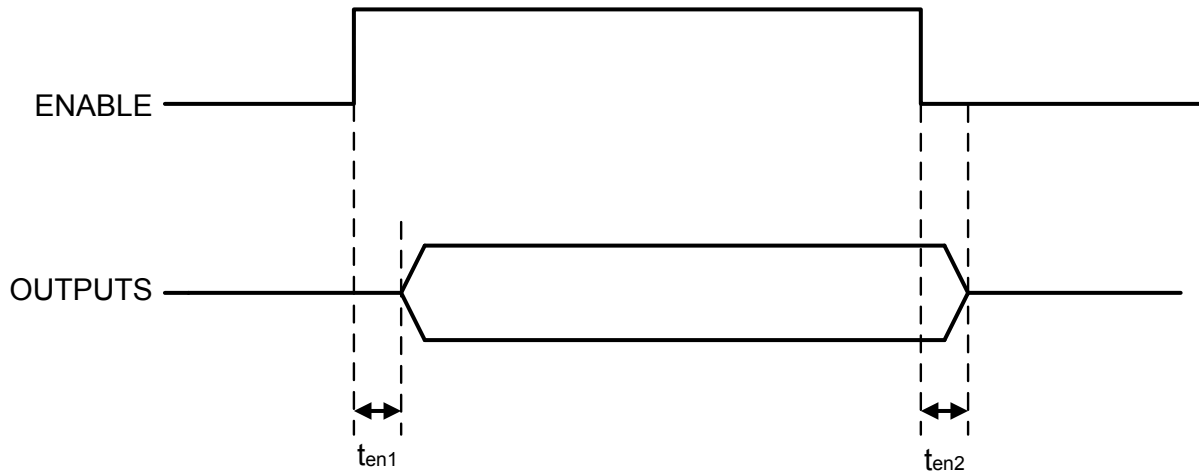

Figure 5.1. ENABLE Timing Diagram

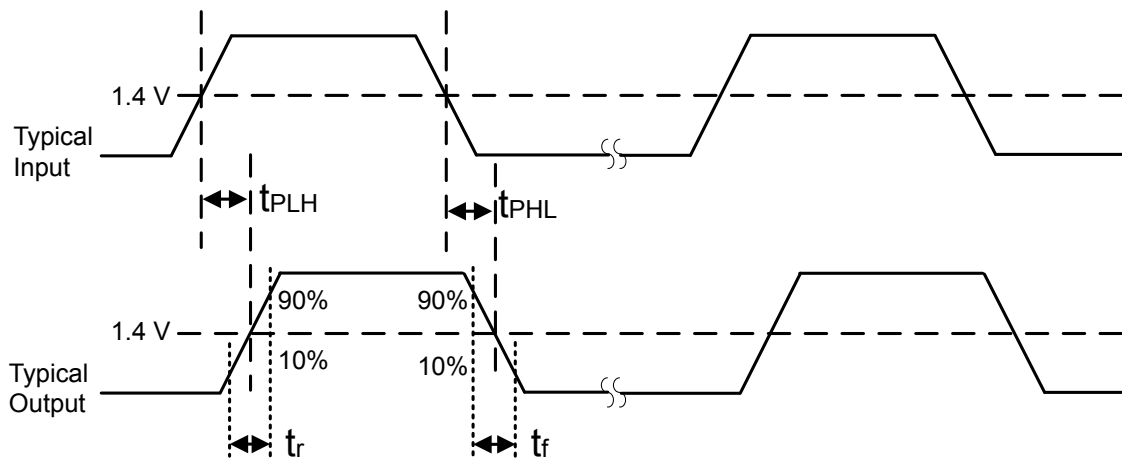

Figure 5.2. Propagation Delay Timing

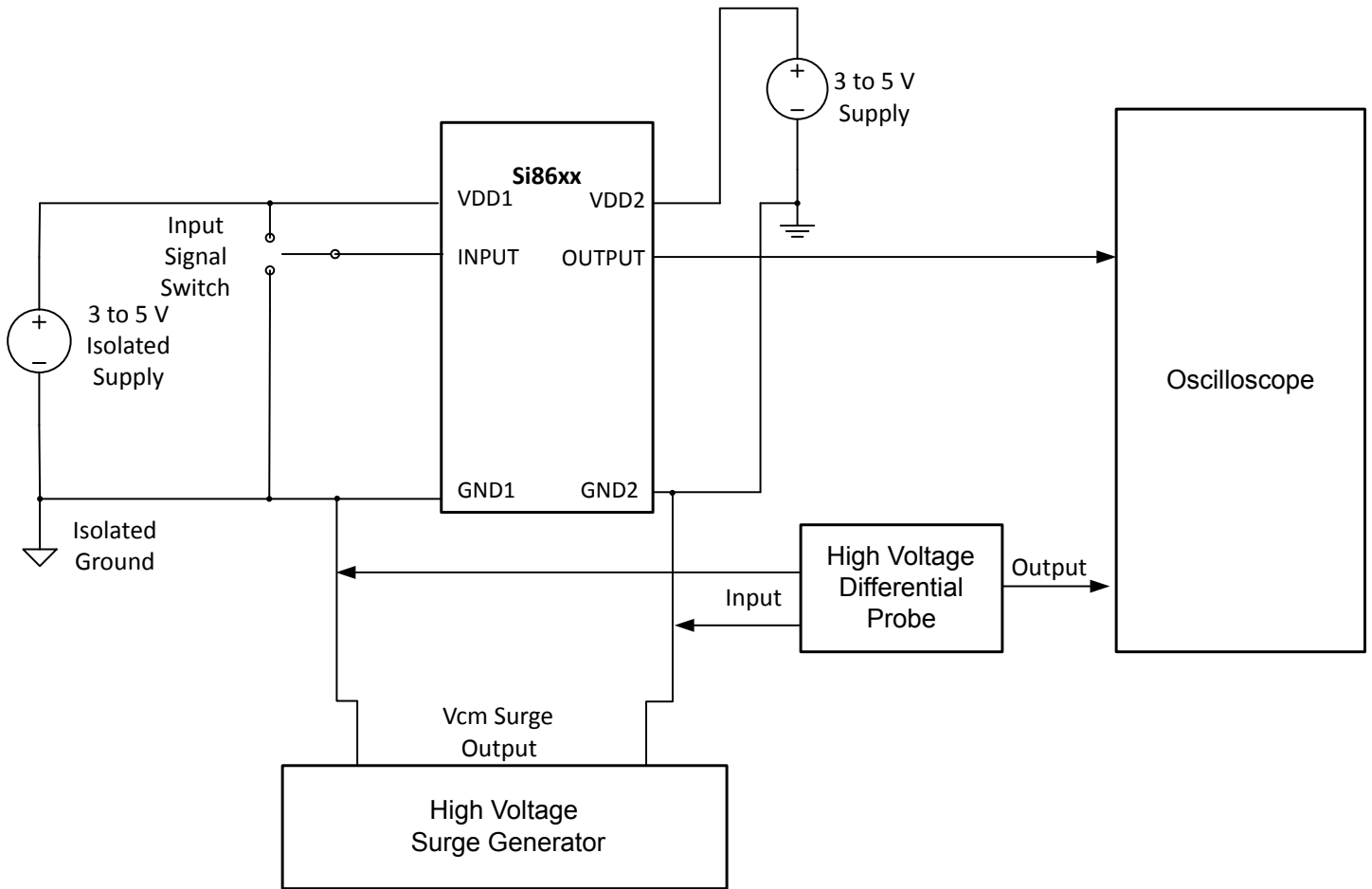

Figure 5.3. Common Mode Transient Immunity Test Circuit

Table 5.3. Electrical Characteristics

(V_{DD1} = 3.3 V±10%, V_{DD2} = 3.3 V±10%, T_A = -40 to 125 °C)

Parameter	Symbol	Test Condition	Min	Typ	Max	Unit
VDD Undervoltage Threshold	VDDUV+	V _{DD1} , V _{DD2} rising	1.95	2.24	2.375	V
VDD Undervoltage Threshold	VDDUV-	V _{DD1} , V _{DD2} falling	1.88	2.16	2.325	V
VDD Undervoltage Hysteresis	VDD _{HYS}		50	70	95	mV
Positive-Going Input Threshold	VT+	All inputs rising	1.4	1.67	1.9	V
Negative-Going Input Threshold	VT-	All inputs falling	1.0	1.23	1.4	V
Input Hysteresis	V _{HYS}		0.38	0.44	0.50	V
High Level Input Voltage	V _{IH}		2.0	—	—	V
Low Level Input Voltage	V _{IL}		—	—	0.8	V
High Level Output Voltage	V _{OH}	I _{oh} = -4 mA	V _{DD1} , V _{DD2} - 0.4	3.1	—	V
Low Level Output Voltage	V _{OL}	I _{ol} = 4 mA	—	0.2	0.4	V
Input Leakage Current	I _L		—	—	±10	µA
Output Impedance ¹	Z _O		—	50	—	Ω
Enable Input High Current	I _{ENH}	V _{ENx} = V _{IH}	—	2.0	—	µA
Enable Input Low Current	I _{ENL}	V _{ENx} = V _{IL}	—	2.0	—	µA
DC Supply Current (All inputs 0 V or at supply)						
Si8650Bx, Ex, Si8655Bx						
V _{DD1}		V _I = 0(Bx), 1(Ex)	—	1.1	1.8	mA
V _{DD2}		V _I = 0(Bx), 1(Ex)	—	3.1	4.7	
V _{DD1}		V _I = 1(Bx), 0(Ex)	—	7.0	9.8	
V _{DD2}		V _I = 1(Bx), 0(Ex)	—	3.3	5.0	
Si8651Bx, Ex						
V _{DD1}		V _I = 0(Bx), 1(Ex)	—	1.5	2.4	mA
V _{DD2}		V _I = 0(Bx), 1(Ex)	—	2.7	4.1	
V _{DD1}		V _I = 1(Bx), 0(Ex)	—	6.6	9.2	
V _{DD2}		V _I = 1(Bx), 0(Ex)	—	4.0	6.0	
Si8652Bx, Ex						
V _{DD1}		V _I = 0(Bx), 1(Ex)	—	2.0	3.0	mA
V _{DD2}		V _I = 0(Bx), 1(Ex)	—	2.4	3.6	
V _{DD1}		V _I = 1(Bx), 0(Ex)	—	5.6	7.8	
V _{DD2}		V _I = 1(Bx), 0(Ex)	—	5.0	7.5	
1 Mbps Supply Current (All inputs = 500 kHz square wave, CI = 15 pF on all outputs)						
Si8650Bx, Ex, Si8655Bx						

Parameter	Symbol	Test Condition	Min	Typ	Max	Unit
V_{DD1}			—	4.1	5.7	mA
V_{DD2}			—	3.7	5.2	
Si8651Bx, Ex						
V_{DD1}			—	4.2	5.8	mA
V_{DD2}			—	3.8	5.3	
Si8652Bx, Ex						
V_{DD1}			—	4.0	5.6	mA
V_{DD2}			—	4.0	5.6	
10 Mbps Supply Current (All inputs = 5 MHz square wave, CI = 15 pF on all outputs)						
Si8650Bx, Ex, Si8655Bx						
V_{DD1}			—	4.1	5.7	mA
V_{DD2}			—	4.4	6.1	
Si8651Bx, Ex						
V_{DD1}			—	4.3	6.0	mA
V_{DD2}			—	4.3	6.0	
Si8652Bx, Ex						
V_{DD1}			—	4.3	6.0	mA
V_{DD2}			—	4.4	6.1	
100 Mbps Supply Current (All inputs = 50 MHz square wave, CI = 15 pF on all outputs)						
Si8650Bx, Ex, Si8655Bx						
V_{DD1}			—	4.1	5.7	mA
V_{DD2}			—	15.5	20.1	
Si8651Bx, Ex						
V_{DD1}			—	6.6	8.9	mA
V_{DD2}			—	13.2	17.1	
Si8652Bx, Ex						
V_{DD1}			—	8.9	11.6	mA
V_{DD2}			—	11.1	14.4	
Timing Characteristics						
Si865xBx, Ex						
Maximum Data Rate			0	—	150	Mbps
Minimum Pulse Width			—	—	5.0	ns
Propagation Delay	t_{PHL}, t_{PLH}	See Figure 5.2 Propagation Delay Timing on page 13	5.0	8.0	13	ns
Pulse Width Distortion $ t_{PLH} - t_{PHL} $	PWD	See Figure 5.2 Propagation Delay Timing on page 13	—	0.2	4.5	ns
Propagation Delay Skew ²	$t_{PSK(P-P)}$		—	2.0	4.5	ns

Parameter	Symbol	Test Condition	Min	Typ	Max	Unit
Channel-Channel Skew	t_{PSK}		—	0.4	2.5	ns
All Models						
Output Rise Time	t_r	$C_L = 15\text{ pF}$ See Figure 5.2 Propagation Delay Timing on page 13	—	2.5	4.0	ns
Output Fall Time	t_f	$C_L = 15\text{ pF}$ (See Figure 5.2 Propagation Delay Timing on page 13)	—	2.5	4.0	ns
Peak eye diagram jitter	$t_{JIT(PK)}$	See Figure 3.3 Eye Diagram on page 4	—	350	—	ps
Common Mode Transient Immunity	CMTI	$V_I = V_{DD}$ or 0 V $V_{CM} = 1500\text{ V}$ (See Figure 5.3 Common Mode Transient Immunity Test Circuit on page 14)	35	50	—	kV/ μ s
Enable to Data Valid	t_{en1}	See Figure 5.1 ENABLE Timing Diagram on page 13	—	6.0	11	ns
Enable to Data Tri-State	t_{en2}	See Figure 5.1 ENABLE Timing Diagram on page 13	—	8.0	12	ns
Start-Up Time ³	t_{SU}		—	15	40	μ s
Notes:						
1. The nominal output impedance of an isolator driver channel is approximately 50 Ω , $\pm 40\%$, which is a combination of the value of the on-chip series termination resistor and channel resistance of the output driver FET. When driving loads where transmission line effects will be a factor, output pins should be appropriately terminated with controlled impedance PCB traces.						
2. $t_{PSK(P-P)}$ is the magnitude of the difference in propagation delay times measured between different units operating at the same supply voltages, load, and ambient temperature.						
3. Start-up time is the time period from the application of power to valid data at the output.						

Table 5.4. Electrical Characteristics $(V_{DD1} = 2.5\text{ V} \pm 5\%, V_{DD2} = 2.5\text{ V} \pm 5\%, T_A = -40\text{ to }125\text{ }^\circ\text{C})$

Parameter	Symbol	Test Condition	Min	Typ	Max	Unit
VDD Undervoltage Threshold	VDDUV+	V_{DD1}, V_{DD2} rising	1.95	2.24	2.375	V
VDD Undervoltage Threshold	VDDUV-	V_{DD1}, V_{DD2} falling	1.88	2.16	2.325	V
VDD Undervoltage Hysteresis	VDDHYS		50	70	95	mV
Positive-Going Input Threshold	VT+	All inputs rising	1.4	1.67	1.9	V
Negative-Going Input Threshold	VT-	All inputs falling	1.0	1.23	1.4	V
Input Hysteresis	V_{HYS}		0.38	0.44	0.50	V
High Level Input Voltage	V_{IH}		2.0	—	—	V
Low Level Input Voltage	V_{IL}		—	—	0.8	V
High Level Output Voltage	V_{OH}	$I_{OH} = -4\text{ mA}$	$V_{DD1}, V_{DD2} - 0.4$	2.3	—	V
Low Level Output Voltage	V_{OL}	$I_{OL} = 4\text{ mA}$	—	0.2	0.4	V

Parameter	Symbol	Test Condition	Min	Typ	Max	Unit
Input Leakage Current	I_L		—	—	±10	μA
Output Impedance ¹	Z_O		—	50	—	Ω
Enable Input High Current	I_{ENH}	$V_{ENx} = V_{IH}$	—	2.0	—	μA
Enable Input Low Current	I_{ENL}	$V_{ENx} = V_{IL}$	—	2.0	—	μA
DC Supply Current (All inputs 0 V or at supply)						
Si8650Bx, Ex, Si8655Bx						
V_{DD1}		$V_I = 0(\text{Bx}), 1(\text{Ex})$	—	1.1	1.8	mA
V_{DD2}		$V_I = 0(\text{Bx}), 1(\text{Ex})$	—	3.1	4.7	
V_{DD1}		$V_I = 1(\text{Bx}), 0(\text{Ex})$	—	7.0	9.8	
V_{DD2}		$V_I = 1(\text{Bx}), 0(\text{Ex})$	—	3.3	5.0	
Si8651Bx, Ex						
V_{DD1}		$V_I = 0(\text{Bx}), 1(\text{Ex})$	—	1.5	2.4	mA
V_{DD2}		$V_I = 0(\text{Bx}), 1(\text{Ex})$	—	2.7	4.1	
V_{DD1}		$V_I = 1(\text{Bx}), 0(\text{Ex})$	—	6.6	9.2	
V_{DD2}		$V_I = 1(\text{Bx}), 0(\text{Ex})$	—	4.0	6.0	
Si8652Bx, Ex						
V_{DD1}		$V_I = 0(\text{Bx}), 1(\text{Ex})$	—	2.0	3.0	mA
V_{DD2}		$V_I = 0(\text{Bx}), 1(\text{Ex})$	—	2.4	3.6	
V_{DD1}		$V_I = 1(\text{Bx}), 0(\text{Ex})$	—	5.6	7.8	
V_{DD2}		$V_I = 1(\text{Bx}), 0(\text{Ex})$	—	5.0	7.5	
1 Mbps Supply Current (All inputs = 500 kHz square wave, CI = 15 pF on all outputs)						
Si8650Bx, Ex, Si8655Bx						
V_{DD1}			—	4.1	5.7	mA
V_{DD2}			—	3.7	5.2	
Si8651Bx, Ex						
V_{DD1}			—	4.2	5.8	mA
V_{DD2}			—	3.8	5.3	
Si8652Bx, Ex						
V_{DD1}			—	4.0	5.6	mA
V_{DD2}			—	4.0	5.6	
10 Mbps Supply Current (All inputs = 5 MHz square wave, CI = 15 pF on all outputs)						
Si8650Bx, Ex, Si8655Bx						
V_{DD1}			—	4.1	5.7	mA
V_{DD2}			—	4.0	5.6	
Si8651Bx, Ex						

Parameter	Symbol	Test Condition	Min	Typ	Max	Unit
V_{DD1}			—	4.2	5.9	mA
V_{DD2}			—	4.0	5.6	
Si8652Bx, Ex						
V_{DD1}			—	4.1	5.8	mA
V_{DD2}			—	4.2	5.9	
100 Mbps Supply Current (All inputs = 50 MHz square wave, CI = 15 pF on all outputs)						
Si8650Bx, Ex, Si8655Bx						
V_{DD1}			—	4.1	5.7	mA
V_{DD2}			—	12.5	16.2	
Si8651Bx, Ex						
V_{DD1}			—	6.0	8.1	mA
V_{DD2}			—	10.8	14	
Si8652Bx, Ex						
V_{DD1}			—	7.6	9.9	mA
V_{DD2}			—	9.3	12.0	
Timing Characteristics						
Si865xBx, Ex						
Maximum Data Rate			0	—	150	Mbps
Minimum Pulse Width			—	—	5.0	ns
Propagation Delay	t_{PHL}, t_{PLH}	See Figure 5.2 Propagation Delay Timing on page 13	5.0	8.0	14	ns
Pulse Width Distortion ($t_{PLH} - t_{PHL}$)	PWD	See Figure 5.2 Propagation Delay Timing on page 13	—	0.2	5.0	ns
Propagation Delay Skew ²	$t_{PSK(P-P)}$		—	2.0	5.0	ns
Channel-Channel Skew	t_{PSK}		—	0.4	2.5	ns
All Models						
Output Rise Time	t_r	$C_L = 15$ pF See Figure 5.2 Propagation Delay Timing on page 13	—	2.5	4.0	ns
Output Fall Time	t_f	$C_L = 15$ pF See Figure 5.2 Propagation Delay Timing on page 13	—	2.5	4.0	ns
Peak Eye Diagram Jitter	$t_{JIT(PK)}$	See Figure 3.3 Eye Diagram on page 4	—	350	—	ps
Common Mode Transient Immunity	CMTI	$V_I = V_{DD}$ or 0 V $V_{CM} = 1500$ V (See Figure 5.3 Common Mode Transient Immunity Test Circuit on page 14)	35	50	—	kV/ μ s

Parameter	Symbol	Test Condition	Min	Typ	Max	Unit
Enable to Data Valid	t_{en1}	See Figure 5.1 ENABLE Timing Diagram on page 13	—	6.0	11	ns
Enable to Data Tri-State	t_{en2}	See Figure 5.1 ENABLE Timing Diagram on page 13	—	8.0	12	ns
Startup Time ³	t_{SU}		—	15	40	μ s

Notes:

- The nominal output impedance of an isolator driver channel is approximately 50 Ω , $\pm 40\%$, which is a combination of the value of the on-chip series termination resistor and channel resistance of the output driver FET. When driving loads where transmission line effects will be a factor, output pins should be appropriately terminated with controlled impedance PCB traces.
- $t_{PSK(P-P)}$ is the magnitude of the difference in propagation delay times measured between different units operating at the same supply voltages, load, and ambient temperature.
- Start-up time is the time period from the application of power to valid data at the output.

Table 5.5. Regulatory Information ¹

CSA
The Si865x is certified under CSA Component Acceptance Notice 5A. For more details, see File 232873.
61010-1: Up to 600 V _{RMS} reinforced insulation working voltage; up to 600 V _{RMS} basic insulation working voltage.
60950-1: Up to 600 V _{RMS} reinforced insulation working voltage; up to 1000 V _{RMS} basic insulation working voltage.
60601-1: Up to 125 V _{RMS} reinforced insulation working voltage; up to 380 V _{RMS} basic insulation working voltage.
VDE
The Si865x is certified according to IEC 60747-5-2. For more details, see File 5006301-4880-0001.
60747-5-2: Up to 1200 V _{peak} for basic insulation working voltage.
60950-1: Up to 600 V _{RMS} reinforced insulation working voltage; up to 1000 V _{RMS} basic insulation working voltage.
UL
The Si865x is certified under UL1577 component recognition program. For more details, see File E257455.
Rated up to 5000 V _{RMS} isolation voltage for basic protection.
CQC
The Si865x is certified under GB4943.1-2011. For more details, see certificates CQC13001096110 and CQC13001096239.
Rated up to 600 V _{RMS} reinforced insulation working voltage; up to 1000 V _{RMS} basic insulation working voltage.
Note:
1. Regulatory Certifications apply to 2.5 kV _{RMS} rated devices which are production tested to 3.0 kV _{RMS} for 1 sec. Regulatory Certifications apply to 3.75 kV _{RMS} rated devices which are production tested to 4.5 kV _{RMS} for 1 sec. Regulatory Certifications apply to 5.0 kV _{RMS} rated devices which are production tested to 6.0 kV _{RMS} for 1 sec. For more information, see 2. Ordering Guide .

Table 5.6. Insulation and Safety-Related Specifications

Parameter	Symbol	Test Condition	Value			Unit
			WB SO-IC-16	NB SO-IC-16	QSOP-16	
Nominal Air Gap (Clearance) ¹	L(IO1)		8.0	4.9	3.6	mm
Nominal External Tracking (Creepage) ¹	L(IO2)		8.0	4.01	3.6	mm
Minimum Internal Gap (Internal Clearance)			0.014	0.014	0.014	mm
Tracking Resistance (Proof Tracking Index)	PTI	IEC60112	600	600	600	V _{RMS}
Erosion Depth	ED		0.019	0.019	0.031	mm
Resistance (Input-Output) ²	R _{IO}		10 ¹²	10 ¹²	10 ¹²	Ω
Capacitance (Input-Output) ²	X _{IO}	f = 1 MHz	2.0	2.0	2.0	pF
Input Capacitance ³	X _I		4.0	4.0	4.0	pF

Notes:

- The values in this table correspond to the nominal creepage and clearance values. VDE certifies the clearance and creepage limits as 4.7 mm minimum for the NB SOIC-16 and QSOP-16 packages and 8.5 mm minimum for the WB SOIC-16 package. UL does not impose a clearance and creepage minimum for component-level certifications. CSA certifies the clearance and creepage limits as 3.9 mm minimum for the NB SOIC-16, 3.6 mm minimum for the QSOP-16 packages and 7.6 mm minimum for the WB SOIC-16 package.
- To determine resistance and capacitance, the Si86xx is converted into a 2-terminal device. Pins 1–8 are shorted together to form the first terminal and pins 9–16 are shorted together to form the second terminal. The parameters are then measured between these two terminals.
- Measured from input pin to ground.

Table 5.7. IEC 60664-1 (VDE 0844 Part 2) Ratings

Parameter	Test Conditions	Specification	
		NB SOIC-16	WB SOIC-16
Basic Isolation Group	Material Group	I	I
Installation Classification	Rated Mains Voltages < 150 V _{RMS}	I-IV	I-IV
	Rated Mains Voltages < 300 V _{RMS}	I-III	I-IV
	Rated Mains Voltages < 400 V _{RMS}	I-II	I-III
	Rated Mains Voltages < 600 V _{RMS}	I-II	I-III

Table 5.8. IEC 60747-5-2 Insulation Characteristics for Si86xxxx ¹

Parameter	Symbol	Test Condition	Characteristic		Unit
			WB SOIC-16	NB SOIC-16	
Maximum Working Insulation Voltage	V_{IORM}		1200	630	Vpeak
Input to Output Test Voltage	V_{PR}	Method b1 ($V_{IORM} \times 1.875 = V_{PR}$, 100% Production Test, $t_m = 1$ sec, Partial Discharge < 5 pC)	2250	1182	
Transient Overvoltage	V_{IOTM}	$t = 60$ sec	6000	6000	Vpeak
Pollution Degree (DIN VDE 0110, Table 1)			2	2	
Insulation Resistance at T_S , $V_{IO} = 500$ V	R_S		$>10^9$	$>10^9$	Ω

Note:

- Maintenance of the safety data is ensured by protective circuits. The Si86xxxx provides a climate classification of 40/125/21.

Table 5.9. IEC Safety Limiting Values ¹

Parameter	Symbol	Test Condition	Max		Unit
			WB SOIC-16	NB SOIC-16	
Case Temperature	T_S		150	150	$^{\circ}\text{C}$
Safety Input, Output, or Supply Current	I_S	$\theta_{JA} = 100$ $^{\circ}\text{C}/\text{W}$ (WB SO-IC-16), 105 $^{\circ}\text{C}/\text{W}$ (NB SOIC-16, QSOP-16), $V_I = 5.5$ V, $T_J = 150$ $^{\circ}\text{C}$, $T_A = 25$ $^{\circ}\text{C}$	220	215	mA
Device Power Dissipation ²	P_D		415	415	mW

Notes:

- Maximum value allowed in the event of a failure; also see the thermal derating curve in [Figure 5.4 \(WB SOIC-16\) Thermal Derating Curve, Dependence of Safety Limiting Values with Case Temperature per DIN EN 60747-5-2 on page 23](#) and [Figure 5.5 \(NB SOIC-16\) Thermal Derating Curve, Dependence of Safety Limiting Values with Case Temperature per DIN EN 60747-5-2 on page 23](#).
- The Si86xx is tested with $VDD1 = VDD2 = 5.5$ V, $T_J = 150$ $^{\circ}\text{C}$, $C_L = 15$ pF, input a 150 Mbps 50% duty cycle square wave.

Table 5.10. Thermal Characteristics

Parameter	Symbol	WB SOIC-16	NB SOIC-16 QSOP-16	Unit
IC Junction-to-Air Thermal Resistance	θ_{JA}	100	105	$^{\circ}\text{C}/\text{W}$

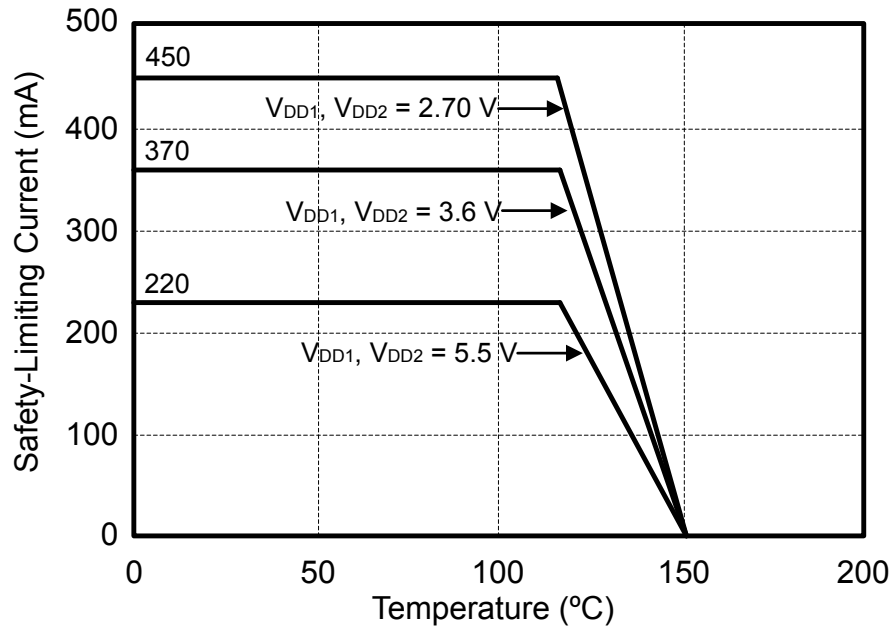

Figure 5.4. (WB SOIC-16) Thermal Derating Curve, Dependence of Safety Limiting Values with Case Temperature per DIN EN 60747-5-2

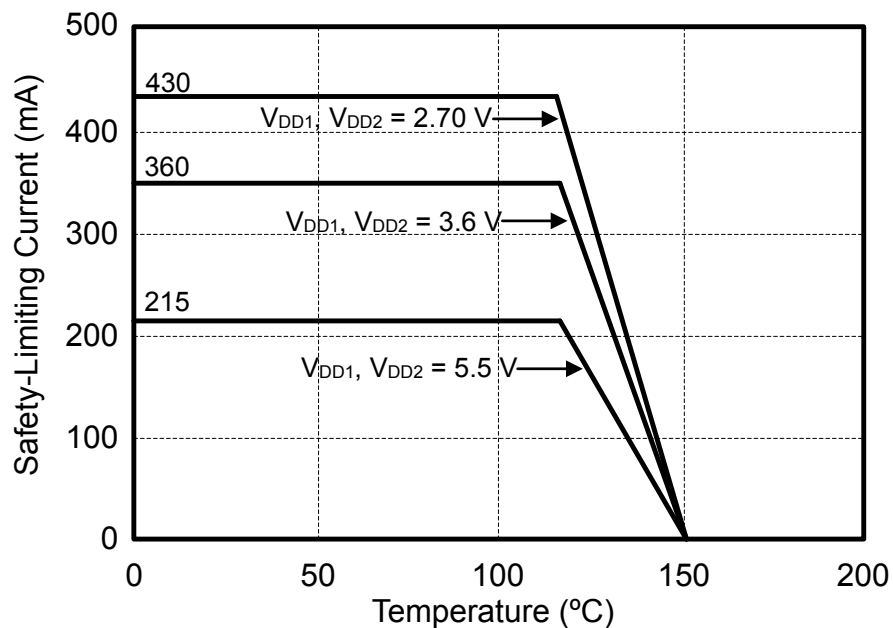

Figure 5.5. (NB SOIC-16) Thermal Derating Curve, Dependence of Safety Limiting Values with Case Temperature per DIN EN 60747-5-2

Table 5.11. Absolute Maximum Ratings ¹

Parameter	Symbol	Min	Max	Unit
Storage Temperature ²	T_{STG}	-65	150	°C
Ambient Temperature Under Bias	T_A	-40	125	°C
Junction Temperature	T_J	—	150	°C
Supply Voltage	V_{DD1}, V_{DD2}	-0.5	7.0	V
Input Voltage	V_I	-0.5	$V_{DD} + 0.5$	V
Output Voltage	V_O	-0.5	$V_{DD} + 0.5$	V
Output Current Drive Channel (All devices unless otherwise stated)	I_O	—	10	mA
Output Current Drive Channel (All Si865xxA-x-xx devices)	I_O	—	22	mA
Latchup Immunity ³		—	100	V/ns
Lead Solder Temperature (10 s)		—	260	°C
Maximum Isolation (Input to Output) (1 sec) NB SOIC-16, QSOP-16		—	4500	V_{RMS}
Maximum Isolation (Input to Output) (1 sec) WB SOIC-16		—	6500	V_{RMS}

Notes:

1. Permanent device damage may occur if the absolute maximum ratings are exceeded. Functional operation should be restricted to conditions as specified in the operational sections of this data sheet.
2. VDE certifies storage temperature from -40 to 150 °C.
3. Latchup immunity specification is for slew rate applied across GND1 and GND2.