



Chipsmall Limited consists of a professional team with an average of over 10 year of expertise in the distribution of electronic components. Based in Hongkong, we have already established firm and mutual-benefit business relationships with customers from,Europe,America and south Asia,supplying obsolete and hard-to-find components to meet their specific needs.

With the principle of “Quality Parts,Customers Priority,Honest Operation,and Considerate Service”,our business mainly focus on the distribution of electronic components. Line cards we deal with include Microchip,ALPS,ROHM,Xilinx,Pulse,ON,Everlight and Freescale. Main products comprise IC,Modules,Potentiometer,IC Socket,Relay,Connector.Our parts cover such applications as commercial,industrial, and automotives areas.

We are looking forward to setting up business relationship with you and hope to provide you with the best service and solution. Let us make a better world for our industry!



## Contact us

Tel: +86-755-8981 8866 Fax: +86-755-8427 6832

Email & Skype: info@chipsmall.com Web: www.chipsmall.com

Address: A1208, Overseas Decoration Building, #122 Zhenhua RD., Futian, Shenzhen, China



## Integrated DrMOS Power Stage

### DESCRIPTION

The SiC769ACD is an integrated solution that contains PWM optimized n-channel MOSFETs (high side and low side) and a full featured MOSFET driver IC. The device complies with the Intel DrMOS standard for desktop and server  $V_{core}$  power stages. The SiC769ACD delivers up to 35 A continuous output current and operates from an input voltage range of 3 V to 16 V. The integrated MOSFETs are optimized for output voltages in the ranges of 0.8 V to 2.0 V with a nominal input voltage of 12 V. The device can also deliver very high power at 5 V output for ASIC applications.

The SiC769ACD incorporates an advanced MOSFET gate driver IC. This IC accepts a single PWM input from the  $V_R$  controller and converts it into the high side and low side MOSFET gate drive signals. The driver IC is designed to implement the skip mode (SMOD) function for light load efficiency improvement. Adaptive dead time control also works to improve efficiency at all load points. The SiC769ACD has a thermal warning (THDN) that alerts the system of excessive junction temperature. The driver IC includes an enable pin, UVLO and shoot through protection. The SiC769ACD is optimized for high frequency buck applications. Operating frequencies in excess of 1 MHz can easily be achieved.

The SiC769ACD is packaged in Vishay Siliconix high performance PowerPAK MLP6 x 6 package. Compact co-packaging of components helps to reduce stray inductance, and hence increases efficiency.

### FEATURES

- Integrated Gen III MOSFETs and DrMOS compliant gate driver IC
- Enables  $V_{core}$  switching at 1 MHz
- Easily achieve > 90 % efficiency in multi-phase, low output voltage solutions
- Low ringing on the VSWH pin reduces EMI
- Pin compatible with DrMOS 6 x 6 version 3.0
- Tri-state PWM input function prevents negative output voltage swing
- 3.3 V logic levels on PWM
- MOSFET threshold voltage optimized for 5 V driver bias supply
- Automatic skip mode operation (SMOD) for light load efficiency
- Under-voltage lockout
- Built-in bootstrap Schottky diode
- Adaptive deadtime and shoot through protection
- Thermal shutdown warning flag
- Low profile, thermally enhanced PowerPAK® MLP 6 x 6 40 pin package
- **Halogen-free according to IEC 61249-2-21 definition**
- **Compliant to RoHS directive 2002/95/EC**



### APPLICATIONS

- CPU and GPU core voltage regulation
- Server, computer, workstation, game console, graphics boards, PC

### SiC769ACD APPLICATION DIAGRAMM

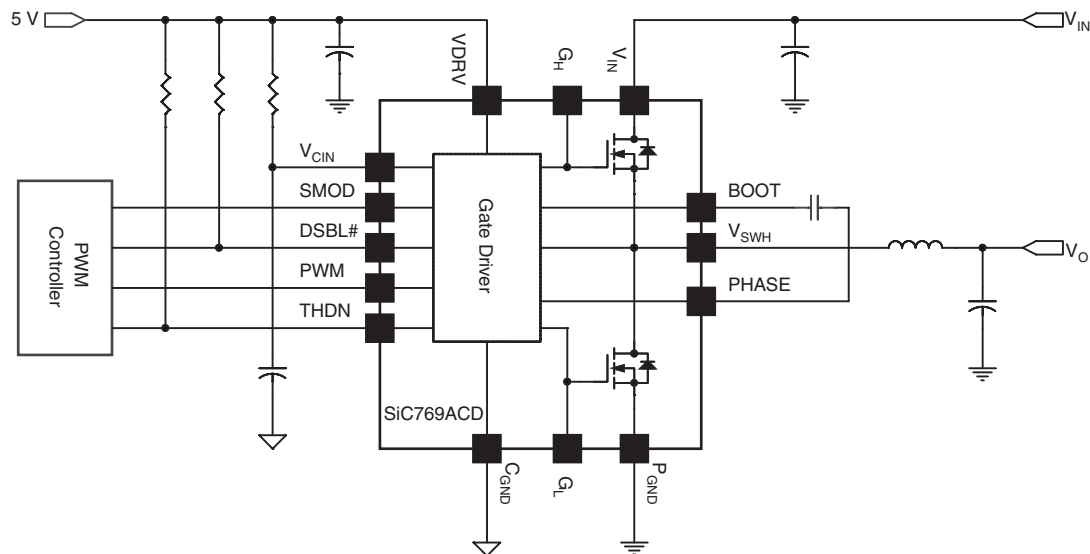

Figure 1

**ORDERING INFORMATION**

Part Number	Package
SiC769ACD-T1-GE3	PowerPAK MLP66-40
SiC769ADB	Reference board

**ABSOLUTE MAXIMUM RATINGS**  $T_A = 25\text{ }^\circ\text{C}$ , unless otherwise noted

Parameter	Symbol	Min.	Max.	Unit
Input Voltage	$V_{IN}$	- 0.3	20	V
Switch Node Voltage (DC)	$V_{SW}$	- 0.3	20	
Drive Input Voltage	$V_{DRV}$	- 0.3	7.0	
Control Input Voltage	$V_{CIN}$	- 0.3	7.0	
Logic Pins	$V_{PWM}, V_{DSBL\#}, V_{THDN}, V_{SMOD}$	- 0.3	$V_{CIN} + 0.3$	
Boot Voltage DC (referenced to $C_{GND}$ )	$V_{BS}$	- 0.3	27	
Boot Voltage < 200 ns Transient (referenced to $C_{GND}$ )		- 0.3	29	
Boot to Phase Voltage DC	$V_{BS\_PH}$	- 0.3	7	
Boot to Phase Voltage < 200 ns		- 0.3	9	
Ambient Temperature Range	$T_A$	- 40	125	
Maximum Junction Temperature	$T_J$		150	$^\circ\text{C}$
Storage Junction Temperature	$T_{STG}$	- 65	150	
Soldering Peak Temperature			260	

Note:

- a.  $T_A = 25\text{ }^\circ\text{C}$  and all voltages referenced to  $P_{GND} = C_{GND}$  unless otherwise noted.

Stresses beyond those listed under "Absolute Maximum Ratings" may cause permanent damage to the device. These are stress ratings only, and functional operation of the device at these or any other conditions beyond those indicated in the operational sections of the specifications is not implied. Exposure to absolute maximum rating/conditions for extended periods may affect device reliability.

**RECOMMENDED OPERATING CONDITIONS**

Parameter	Symbol	Min.	Typ.	Max.	Unit
Input Voltage	$V_{IN}$	3.0	12	16	V
Control Input Voltage	$V_{CIN}$	4.5		5.5	
Drive Input Voltage	$V_{DRV}$	4.5		5.5	
Switch Node	$V_{SW\_DC}$		12	16	

Note:

- a. Recommended operating conditions are specified over the entire temperature range, and all voltages referenced to  $P_{GND} = C_{GND}$  unless otherwise noted.

**THERMAL RESISTANCE RATINGS**

Parameter	Symbol	Typ.	Max.	Unit
Maximum Power Dissipation at $T_{PCB} = 25\text{ }^\circ\text{C}$	$P_{D\_25C}$		25	W
Maximum Power Dissipation at $T_{PCB} = 100\text{ }^\circ\text{C}$	$P_{D\_100C}$		10	
Thermal Resistance from Junction to Top	$R_{th\_J\_TOP}$		15	$^\circ\text{C}/\text{W}$
Thermal Resistance from Junction to PCB	$R_{th\_J\_PCB}$		5	





<b>ELECTRICAL SPECIFICATIONS</b>						
Parameter	Symbol	Test Conditions Unless Specified $V_{DSBL\#} = V_{SMOD} = 5\text{ V}$ , $V_{IN} = 12\text{ V}$ , $V_{VDRV} = V_{VCIN} = 5\text{ V}$ , $T_A = 25\text{ }^\circ\text{C}$	Min.	Typ. <sup>a</sup>	Max.	Unit
<b>Power Supplies</b>						
$V_{CIN}$ Control Input Current	$I_{VCIN}$	$V_{DSBL\#} = 0\text{ V}$ , no switching		20		$\mu\text{A}$
		$V_{DSBL\#} = 5\text{ V}$ , no switching		400		
		$V_{DSBL\#} = 5\text{ V}$ , $f_s = 300\text{ kHz}$ , $D = 0.1$		600		
Drive Input Current (Dynamic)	$I_{VDRV}$	$f_s = 300\text{ kHz}$ , $D = 0.1$		14	18	$\text{mA}$
		$f_s = 1000\text{ kHz}$ , $D = 0.1$		40	54	
<b>Bootstrap Supply</b>						
Bootstrap Switch Forward Voltage	$V_{BS}$ Diode	$V_{VCIN} = 5\text{ V}$ , forward bias current 2 mA		0.60	0.75	V
<b>Control Inputs (PWM, DSBL#, SMOD)</b>						
PWM Rising Threshold	$V_{th\_pwm\_r}$		1.8	2	2.3	V
PWM Falling Threshold	$V_{th\_pwm\_f}$		0.8	1.0	1.2	
PWM Tristate Rising Threshold	$V_{th\_tri\_r}$		0.9	1.3	1.8	
PWM Tristate Falling Threshold	$V_{th\_tri\_f}$		1.6	1.8	2	
PWM Tristate Rising Threshold Hysteresis	$V_{hys\_tri\_r}$			220		$\text{mV}$
PWM Tristate Falling Threshold Hysteresis	$V_{hys\_tri\_f}$			240		
Tristate Hold-Off Time <sup>b</sup>	$t_{TSHO}$			150		ns
PWM Input Current	$I_{PWM}$	$V_{PWM} = 3.3\text{ V}$		22		$\mu\text{A}$
		$V_{PWM} = 0\text{ V}$		- 17		
SMOD, DSBL# Logic Input Voltage	$V_{LOGIC\_LH}$	Rising (low to high)	2.0			V
	$V_{LOGIC\_LH}$	Falling (high to low)			0.8	
Pull Down Impedance	$R_{THDN}$	5 k $\Omega$ resistor pull-up to $V_{CIN}$		40		$\Omega$
THDN Output Low	$V_{THDNL}$			0.04		V
<b>Protection</b>						
Thermal Warning Flag Set				150		$^\circ\text{C}$
Thermal Warning Flag Clear				135		
Thermal Warning Flag Hysteresis				15		
Under Voltage Lockout ( $V_{CIN}$ )	$V_{UVLO}$	Rising, on threshold		3.3	3.9	V
Under Voltage Lockout ( $V_{CIN}$ )		Falling, off threshold	2.5	2.9		
Under Voltage Lockout Hysteresis ( $V_{CIN}$ )	$V_{UVLO\_HYST}$			400		$\text{mV}$
High Side Gate Discharge Resistor <sup>b</sup>	$R_{HS\_DSCRG}$	$V_{VDRV} = V_{VCIN} = 0\text{ V}$ ; $V_{IN} = 12\text{ V}$		20.2		k $\Omega$

Notes:

- a. Typical limits are established by characterization and are not production tested.
- b. Guaranteed by design.

<b>MOSFET SPECIFICATIONS</b>						
Parameter	Symbol	Test Conditions Unless Specified $V_{VCIN} = V_{DSBL\#} = 5\text{ V}$ , $V_{VIN} = 12\text{ V}$ , $T_A = 25\text{ }^\circ\text{C}$	Min.	Typ. <sup>a</sup>	Max.	Unit
High Side	$V_{DS}$	$V_{GS} = 0\text{ V}$ , $I_{DS} = 250\text{ }\mu\text{A}$	20			V
	$R_{DS(on)_H}$	$V_{GH} = 5\text{ V}$ , resistance measured at package pins		6.0		$\text{m}\Omega$
Low Side	$V_{DS}$	$V_{GS} = 0\text{ V}$ , $I_{DS} = 250\text{ }\mu\text{A}$	20			V
	$R_{DS(on)_L}$	$V_{GL} = 5\text{ V}$ , resistance measured at package pins		1.7		$\text{m}\Omega$

Note:

- a. Typical MOSFET parameters are provided as a design guide.

## TIMING SPECIFICATIONS

Parameter	Symbol	Test Conditions Unless Specified $V_{VDRV} = V_{VCIN} = V_{DSBL\#} = 5\text{ V}$ , $V_{VIN} = 12\text{ V}$ , $T_A = 25\text{ }^\circ\text{C}$	Min.	Typ.	Max.	Unit
Turn Off Propagation Delay High Side <sup>a</sup>	$t_{d\_off\_HS}$	25 % of PWM to 90 % of GH	10	20	30	ns
Rise Time High Side	$t_{r\_HS}$	10 % to 90 % of GH		8		
Fall Time High Side	$t_{f\_HS}$	90 % to 10 % of GH		8		
Turn Off Propagation Delay Low Side <sup>a</sup>	$t_{d\_off\_LS}$	75 % of PWM to 90 % of GL	10	20	30	
Rise Time Low Side	$t_{r\_LS}$	10 % to 90 % of GL		8		
Fall Time Low Side	$t_{f\_LS}$	90 % to 10 % of GL		8		
Dead Time Rising	$t_{dead\_on}$	10 % of GL to 10 % of GH		15		
Dead Time Falling	$t_{dead\_off}$	10 % of GH to 10 % of GL		15		

Note:

a. Min. and Max. are not 100 % production tested.

## TIMING DEFINITIONS

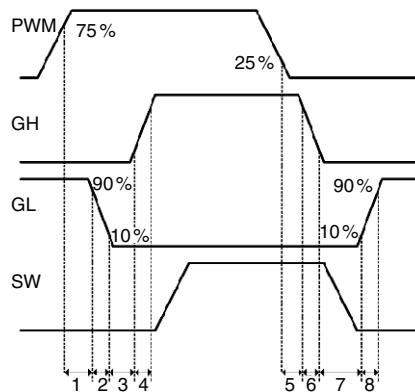

Region	Definition	Symbol
1	Turn off propagation delay LS	$t_{d\_off\_LS}$
2	Fall time LS	$t_{f\_LS}$
3	Dead time rising	$t_{dead\_on}$
4	Rise time HS	$t_{r\_HS}$
5	Turn off propagation delay HS	$t_{d\_off\_HS}$
6	Fall time HS	$t_{f\_HS}$
7	Dead time falling	$t_{dead\_off}$
8	Rise time LS	$t_{r\_LS}$

Note:

GH is referenced to the high side source. GL is referenced to the low side source.

**SiC769ACD BLOCK DIAGRAM**

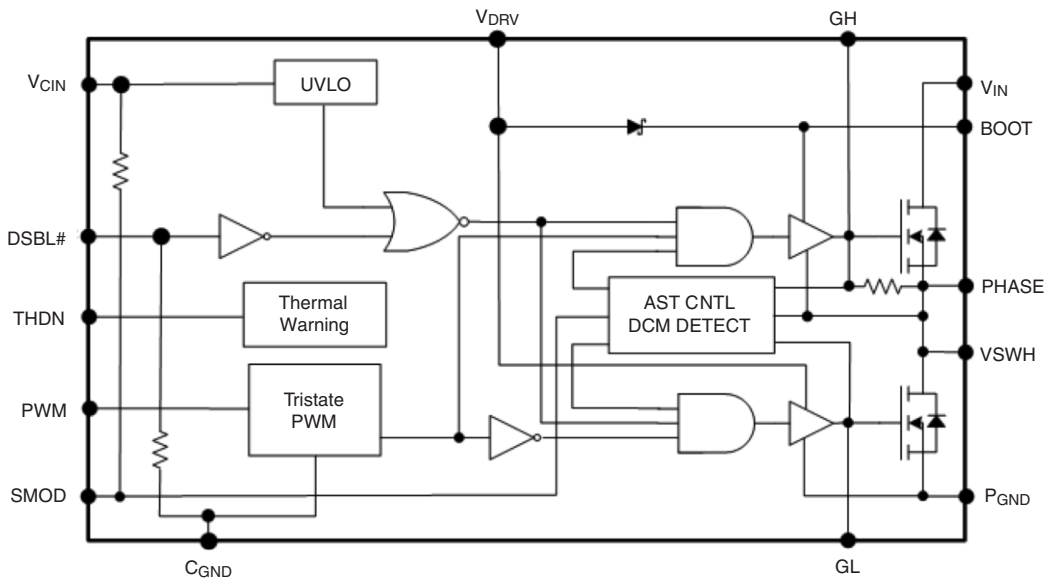

**Figure 2**

## DETAILED OPERATIONAL DESCRIPTION

### PWM Input with Tristate Function

The PWM input receives the PWM control signal from the  $V_R$  controller IC. The PWM input is designed to be compatible with standard controllers using two state logic (H and L) and advanced controllers that incorporate Tristate logic (H, L and Tristate) on the PWM output. For two state logic, the PWM input operates as follows. When PWM is driven above  $V_{th\_pwm\_r}$  the low side is turned off and the high side is turned on. When PWM input is driven below  $V_{th\_pwm\_f}$  the high side turns off and the Low side turns on. For Tristate logic, the PWM input operates as above for driving the MOSFETs. However, there is a third state that is entered into as the PWM output of Tristate compatible controller enters its high impedance state during shut-down. The high impedance state of the controller's PWM output allows the SiC769ACD to pull the PWM input into the Tristate region (see the Tristate Voltage Threshold Diagram below). If the PWM input stays in this region for the Tristate Hold-Off Period,  $t_{TSHO}$ , both high side and low side MOSFETs are turned off. This function allows the  $V_R$  phase to be disabled without negative output voltage swing caused by inductor ringing and saves a Schottky diode clamp. The PWM and Tristate regions are separated by hysteresis to prevent false triggering. The SiC769ACD incorporates logic thresholds that are compatible with 3.3 V logic.

### Disable (DSBL#)

In the low state, the DSBL# pin shuts down the driver IC and disables both high-side and low-side MOSFET. In this state, the standby current is minimized. If DSBL# is left unconnected an internal pull-down resistor will pull the pin down to  $C_{GND}$  and shut down the IC.

### Diode Emulation Mode (SMOD) Skip Mode

When SMOD pin is low the diode emulation mode is enabled. This is a non-synchronous conversion mode that improves light load efficiency by reducing switching losses. Conducted losses that occur in synchronous buck regulators when inductor current is negative are also reduced. Circuitry in the gate drive IC detects when inductor current crosses zero and automatically stops switching the low side MOSFET. See SMOD Operation Diagram for additional details. This function can also be used for a pre-biased output voltage. If SMOD is left unconnected, an internal pull up resistor will pull the pin up to  $V_{CIN}$  (Logic High) to disable the diode emulation function.

### Thermal Shutdown Warning (THDN)

The THDN pin is an open drain signal that flags the presence of excessive junction temperature. Connect a maximum of 20 k $\Omega$  to pull this pin up to  $V_{CIN}$ . An internal temperature sensor detects the junction temperature. The temperature threshold is 150 °C. When this junction temperature is exceeded the THDN flag is set. When the junction temperature drops below 135 °C the device will clear the THDN signal. The SiC769ACD does not stop operation when the flag is set. The decision to shutdown must be made by an external thermal control function.

### Voltage Input ( $V_{IN}$ )

This is the power input to the drain of the high-side Power MOSFET. This pin is connected to the high power intermediate BUS rail.

### Switch Node ( $V_{SWH}$ and PHASE)

The Switch node  $V_{SWH}$  is the circuit PWM regulated output. This is the output applied to the filter circuit to deliver the regulated high output for the buck converter. The PHASE pin is internally connected to the switch node  $V_{SWH}$ . This pin is to be used exclusively as the return pin for the BOOT capacitor. A 20.2 k $\Omega$  resistor is connected between GH and PHASE to provide a discharge path for the HS MOSFET in the event that  $V_{CIN}$  goes to zero while  $V_{IN}$  is still applied.

### Ground connections ( $C_{GND}$ and $P_{GND}$ )

$P_{GND}$  (power ground) should be externally connected to  $C_{GND}$  (control signal ground). The layout of the Printed Circuit Board should be such that the inductance separating the  $C_{GND}$  and  $P_{GND}$  should be a minimum. Transient differences due to inductance effects between these two pins should not exceed 0.5 V.

### Control and Drive Supply Voltage Input ( $V_{DRV}$ , $V_{CIN}$ )

$V_{CIN}$  is the bias supply for the gate drive control IC.  $V_{DRV}$  is the bias supply for the gate drivers. It is recommended to separate these pins through a resistor. This creates a low pass filtering effect to avoid coupling of high frequency gate drive noise into the IC.

### Bootstrap Circuit (BOOT)

The internal bootstrap switch and an external bootstrap capacitor form a charge pump that supplies voltage to the BOOT pin. An integrated bootstrap diode is incorporated so that only an external capacitor is necessary to complete the bootstrap circuit. Connect a boot strap capacitor with one leg tied to BOOT pin and the other tied to PHASE pin.

### Shoot-Through Protection and Adaptive Dead Time (AST)

The SiC769ACD has an internal adaptive logic to avoid shoot through and optimize dead time. The shoot through protection ensures that both high-side and low-side MOSFET are not turned on the same time. The adaptive dead time control operates as follows. When PWM input goes high the LS gate starts to go low after a few ns. When this signal crosses through 1.7 V the logic to switch the HS gate on is activated. When PWM goes low the HS gate goes low. When the HS gate-to-source drive signal crosses through 1.7 V the logic to turn on the LS gate is activated. This feature helps to adjust dead time as gate transitions change with respect to output current and temperature.

### Under Voltage Lockout (UVLO)

During the start up cycle, the UVLO disables the gate drive holding high-side and low-side MOSFET gate low until the input voltage rail has reached a point at which the logic circuitry can be safely activated. The SiC769ACD also incorporates logic to clamp the gate drive signals to zero when the UVLO falling edge triggers the shutdown of the device. As an added precaution, a 20.2 k $\Omega$  resistor is connected between GH and PHASE to provide a discharge path for the HS MOSFET.

DEVICE TRUTH TABLE				
DSBL#	SMOD	PWM	GH	GL
Open	X	X	L	L
L	X	X	L	L
H	L	L	L	H ( $I_L > 0$ ), L ( $I_L \leq 0$ )
H	L	H	H	L
H	H	H	H	L
H	H	L	L	H

**TRISTATE PWM VOLTAGE THRESHOLD DIAGRAM**

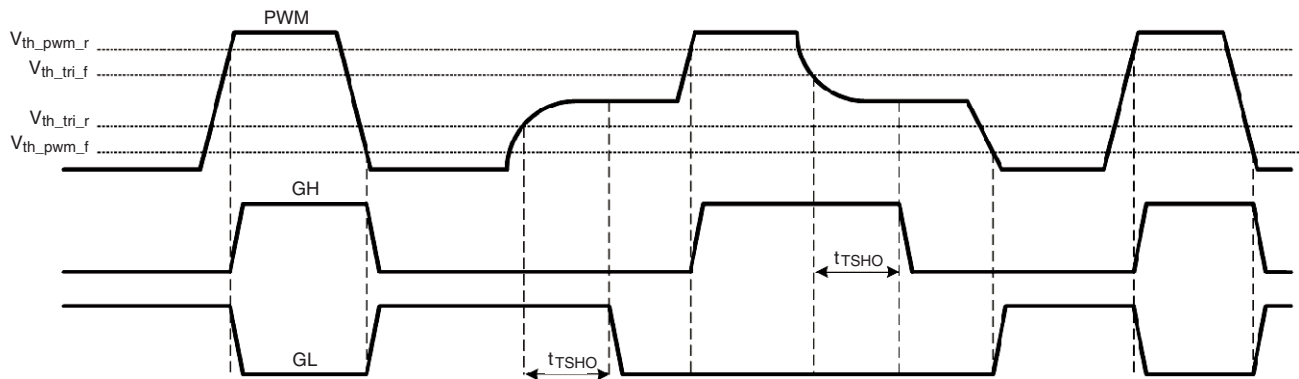

Figure 3

**SMOD OPERATION DIAGRAM**

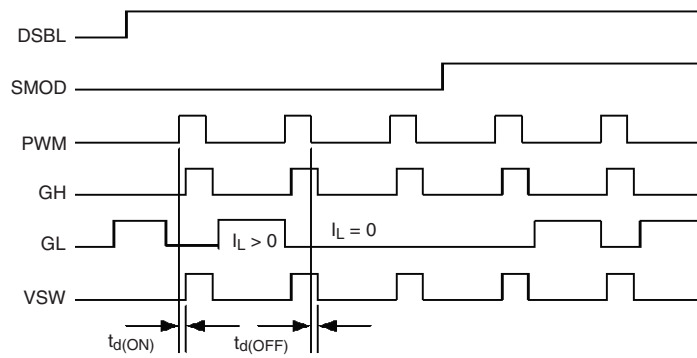

Figure 4



## PIN CONFIGURATION

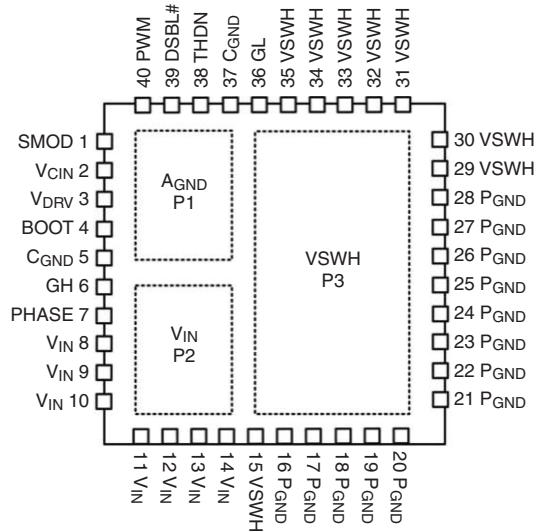
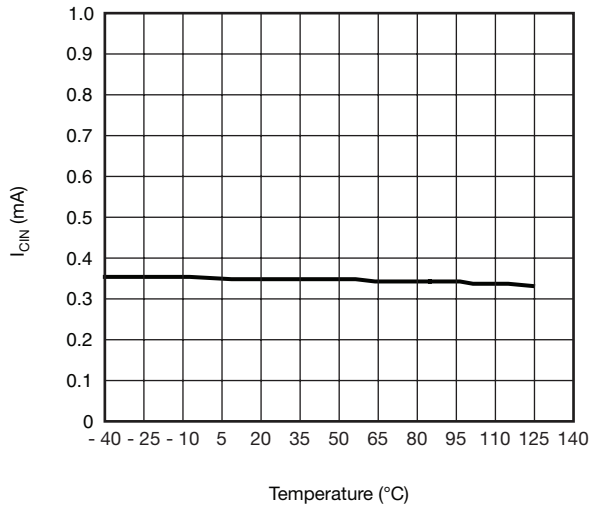

Figure 5 - PowerPAK MLP 6 x 6 40P Pin Out - Top View

PIN DESCRIPTION		
Pin Number	Symbol	Description
1	SMOD	Disable low side gate operation. Active low.
2	V <sub>CIN</sub>	This will be the bias supply input for control IC (5 V).
3	V <sub>DRV</sub>	IC bias supply and gate drive supply voltage (5 V).
4	BOOT	High side driver bootstrap voltage pin for external bootstrap capacitor.
5, 37, PAD1	C <sub>GND</sub>	Control signal ground. It should be connected to P <sub>GND</sub> externally. All pins internally connected.
6	GH	Gate signal output pin for high side MOSFET. Pin for monitoring.
7	PHASE	Return pin for the HS bootstrap capacitor. Connect a 0.1 μF ceramic capacitor from this pin to the boot pin (4).
8 to 14, PAD2	V <sub>IN</sub>	Input voltage for power stage. It is the drain of the high-side MOSFET.
15, 29 to 35, PAD3	VSWH	It is the phase node between high side MOSFET source and low side MOSFET drain. It should be connected to an output inductor. All pins internally connected.
16 to 28	P <sub>GND</sub>	Power ground.
36	GL	Gate signal output pin for low side MOSFET. Pin for monitoring.
38	THDN	Thermal shutdown open drain output. Use a 10K pull up resistor to V <sub>CIN</sub> .
39	DSBL#	Disable pin. Active low.
40	PWM	PWM input logic signal. Compatible with Tristate controller function.

**ELECTRICAL CHARACTERISTICS**



$I_{CIN}$  (mA) vs. Temperature at Frequency = 300 kHz  
D = 10 %,  $V_{CIN} = V_{DRV} = 5$  V

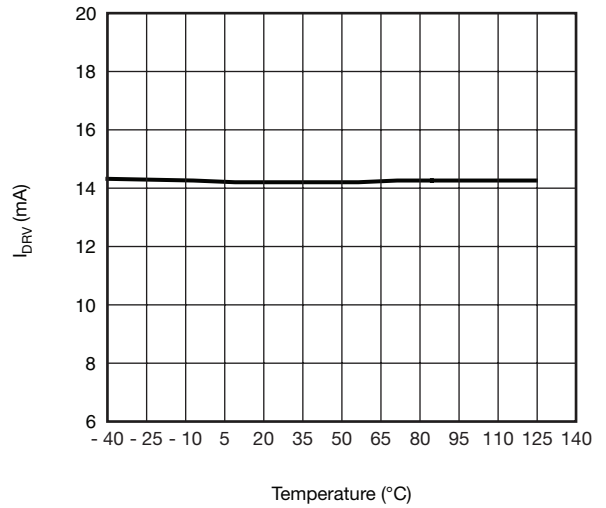

$I_{DRV}$  (mA) vs. Temperature at Frequency = 300 kHz  
D = 10 %,  $V_{CIN} = V_{DRV} = 5$  V

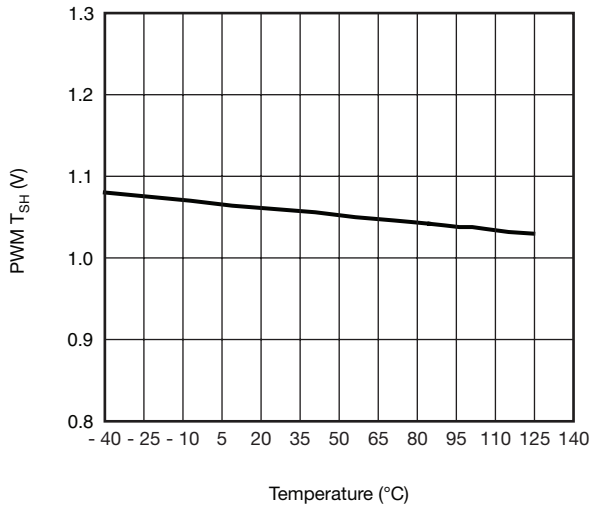

PWM Falling Threshold (V) vs. Temperature (°C)  
 $V_{CIN} = V_{DRV} = 5$  V

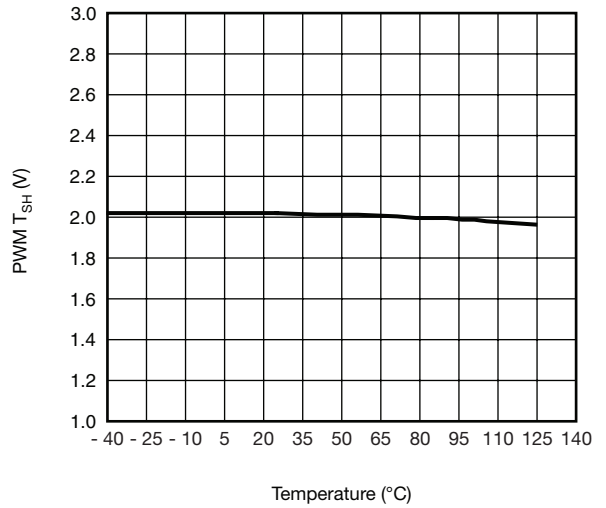

PWM Rising Threshold (V) vs. Temperature (°C)  
 $V_{CIN} = V_{DRV} = 5$  V

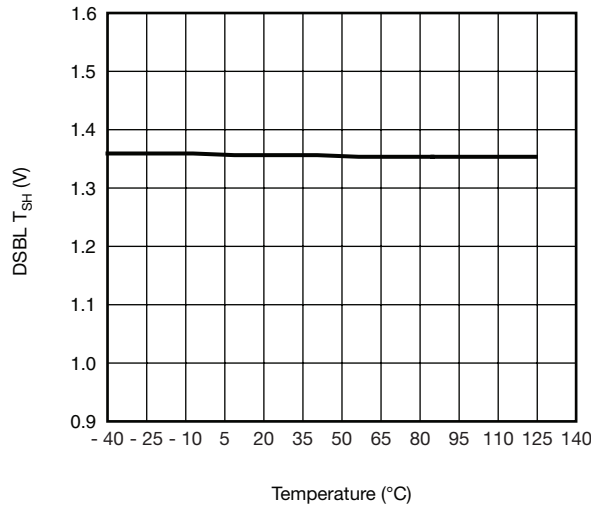

DSBL Falling Threshold (V) vs. Temperature (°C)  
 $V_{CIN} = V_{DRV} = 5$  V

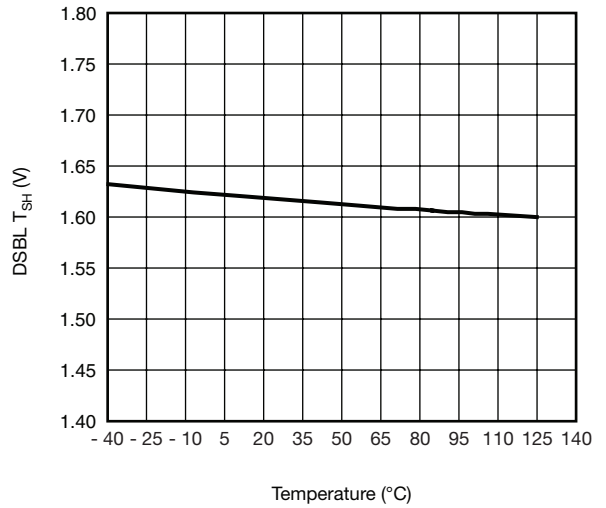

DSBL Rising Threshold (V) vs. Temperature (°C)  
 $V_{CIN} = V_{DRV} = 5$  V

**ELECTRICAL CHARACTERISTICS**

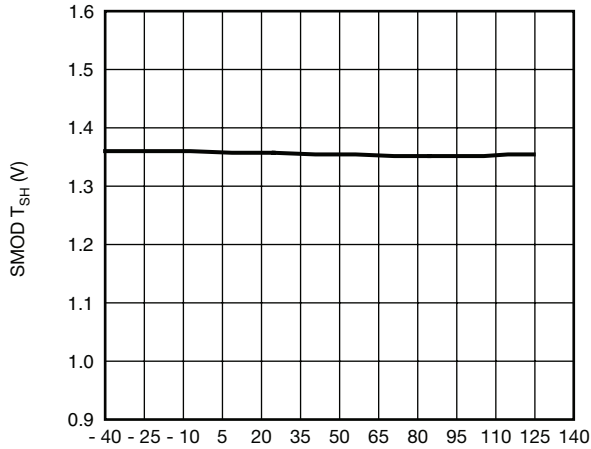

Temperature (°C)  
**SMOD Falling Threshold (V) vs. Temperature (°C)**  
 $V_{CIN} = V_{DRV} = 5 V$

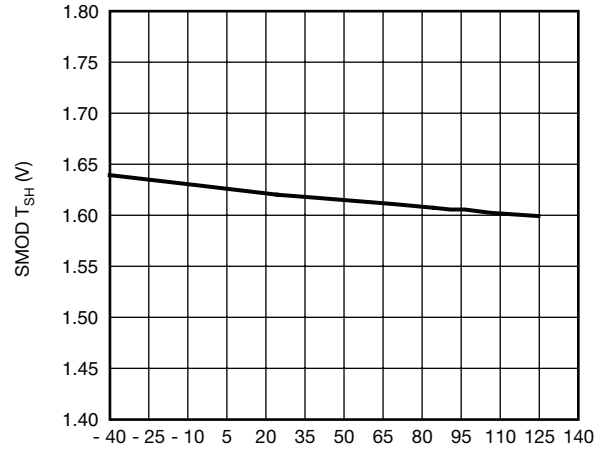

Temperature (°C)  
**SMOD Rising Threshold (V) vs. Temperature (°C)**  
 $V_{CIN} = V_{DRV} = 5 V$

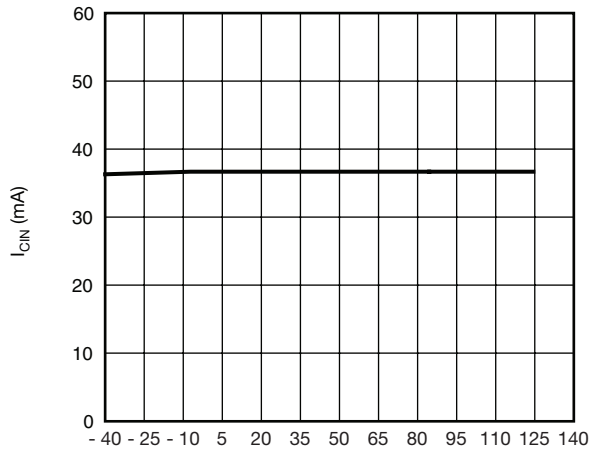

Temperature (°C)  
**ICIN + IDRV (mA) vs. Temperature at Frequency = 1 MHz**  
 $D = 10 \%, V_{CIN} = V_{DRV} = 5 V$

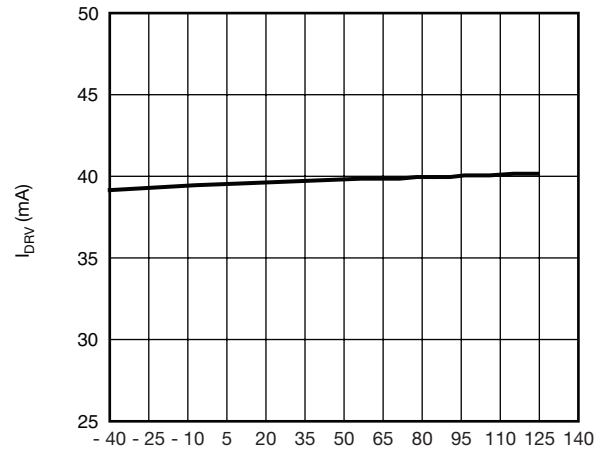

Temperature (°C)  
**IDRV (mA) vs. Temperature at Frequency = 1 MHz**  
 $D = 10 \%, V_{CIN} = V_{DRV} = 5 V$

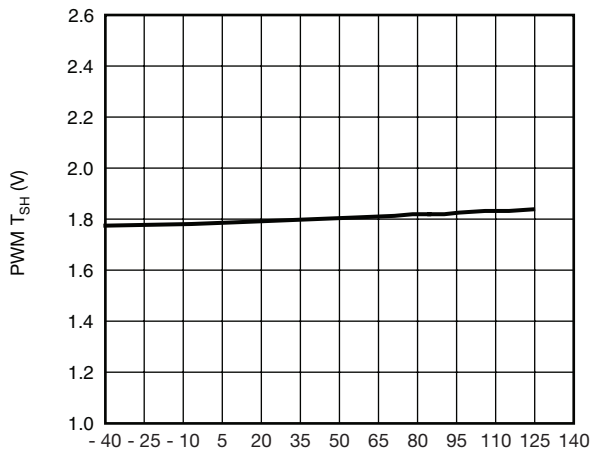

Temperature (°C)  
**PWM Falling Tristate (V) vs. Temperature (°C)**  
 $V_{CIN} = V_{DRV} = 5 V$

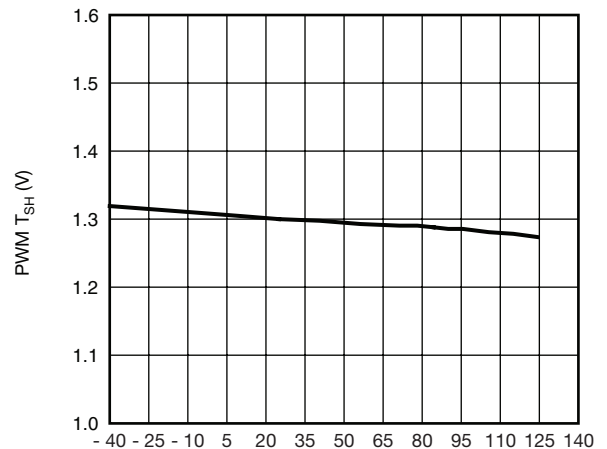

Temperature (°C)  
**PWM Rising Tristate Threshold (V) vs. Temperature (°C)**  
 $V_{CIN} = V_{DRV} = 5 V$

**ELECTRICAL CHARACTERISTICS**

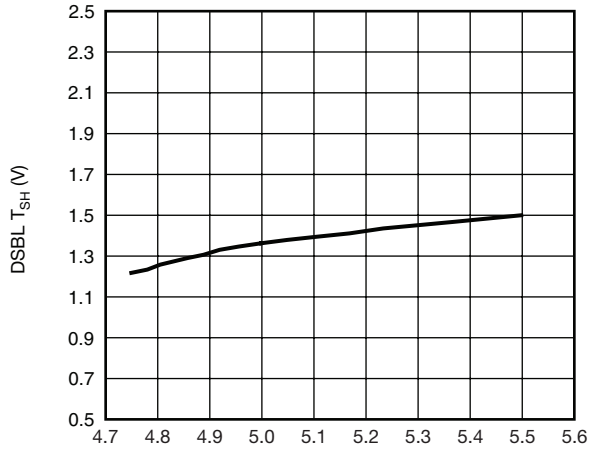

DSBL Falling Threshold vs. V<sub>CIN</sub>

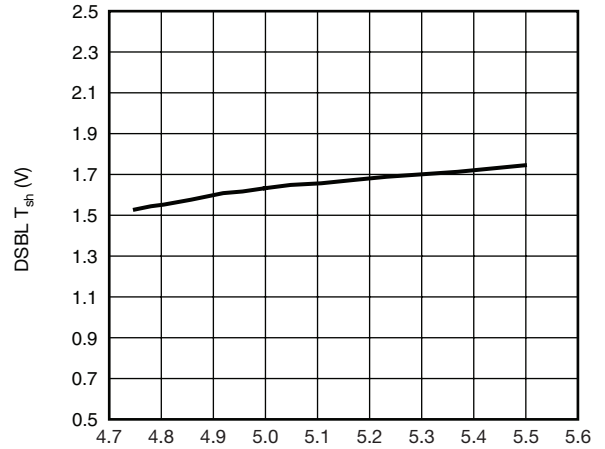

DSBL Rising Threshold vs. V<sub>CIN</sub>

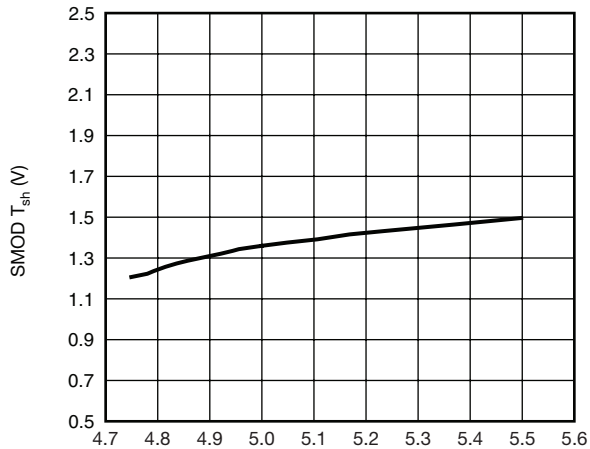

SMOD Falling Threshold vs. V<sub>CIN</sub>

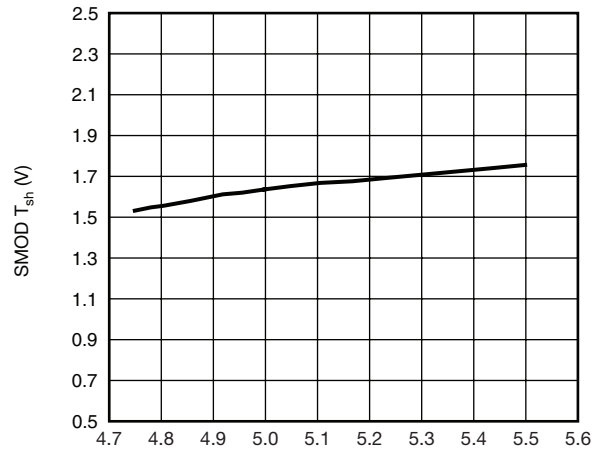

SMOD Rising Threshold vs. V<sub>CIN</sub>

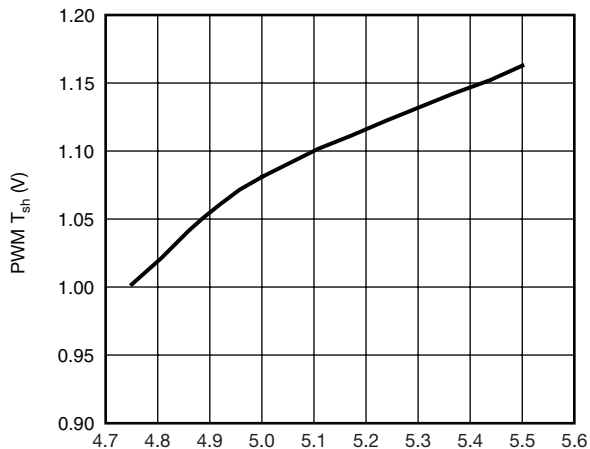

PWM Falling Threshold vs. V<sub>CIN</sub>

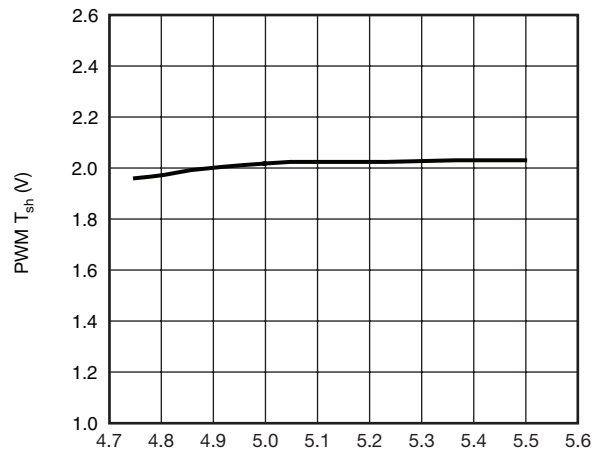

PWM Rising Threshold vs. V<sub>CIN</sub>

**ELECTRICAL CHARACTERISTICS**

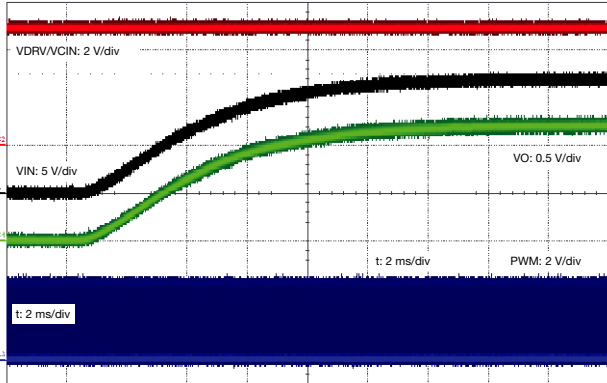

**Startup with  $V_{IN}$  Ramping Up**  
 $V_{IN} = 12\text{ V}$ ,  $V_{OUT} = 1.2\text{ V}$ ,  $f_S = 500\text{ kHz}$

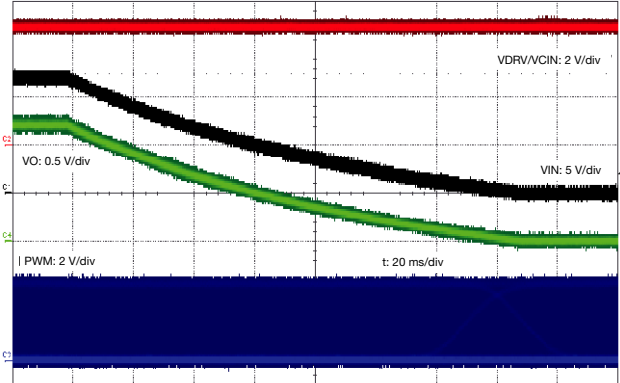

**Power Off with  $V_{IN}$  Ramping Down**  
 $V_{IN} = 12\text{ V}$ ,  $V_{OUT} = 1.2\text{ V}$ ,  $f_S = 500\text{ kHz}$

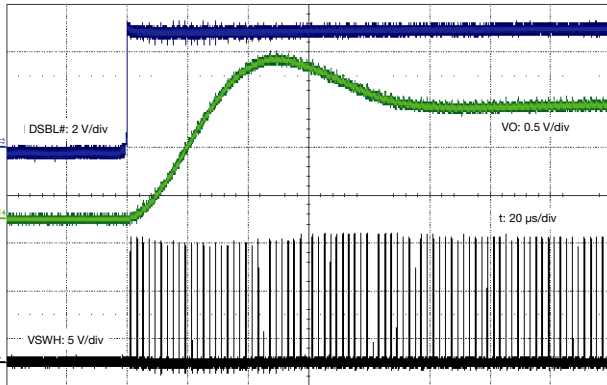

**Enable with  $V_{IN} = 12\text{ V}$ ,  $V_{OUT} = 1.2\text{ V}$ ,  $f_S = 500\text{ kHz}$**

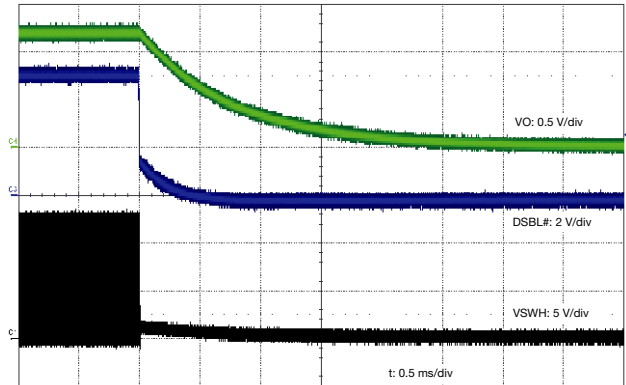

**Disable with  $V_{IN} = 12\text{ V}$ ,  $V_{OUT} = 1.2\text{ V}$ ,  $f_S = 500\text{ kHz}$**

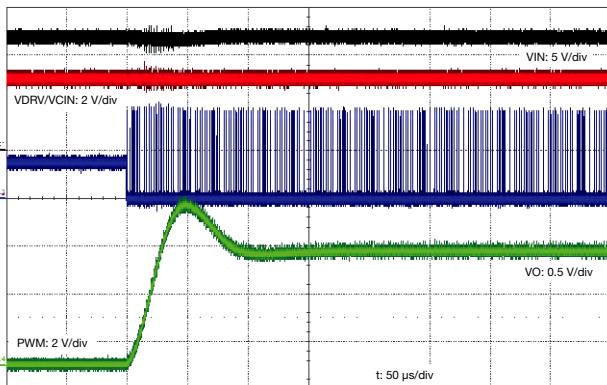

**PWM Start with  $V_{IN} = 12\text{ V}$ ,  $V_{OUT} = 1.2\text{ V}$ ,  $f_S = 500\text{ kHz}$**

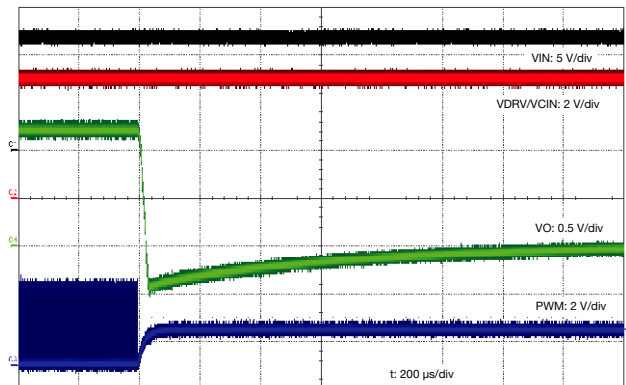

**PWM Turn-off with  $V_{IN} = 12\text{ V}$ ,  $V_{OUT} = 1.2\text{ V}$ ,  $f_S = 500\text{ kHz}$**



## ELECTRICAL CHARACTERISTICS

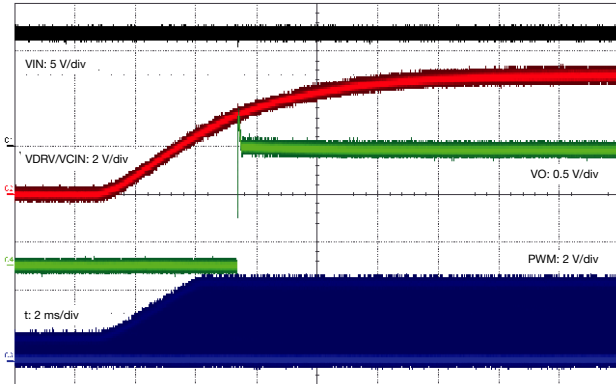

Startup with  $V_{DRV}/V_{CIN}$  Ramping Up  
 $V_{IN} = 12\text{ V}$ ,  $V_{OUT} = 1.2\text{ V}$ ,  $f_S = 500\text{ kHz}$

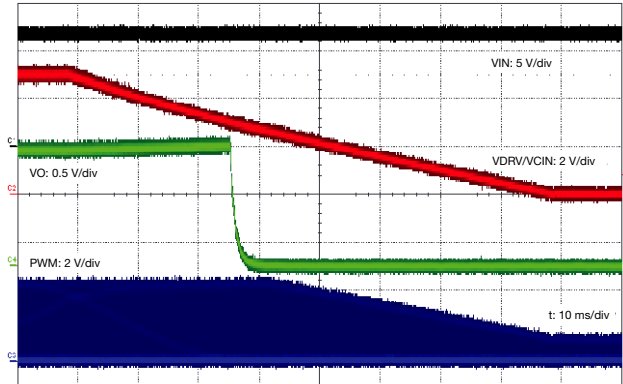

Power Off with  $V_{DRV}/V_{CIN}$  Ramping Down  
 $V_{IN} = 12\text{ V}$ ,  $V_{OUT} = 1.2\text{ V}$ ,  $f_S = 500\text{ kHz}$

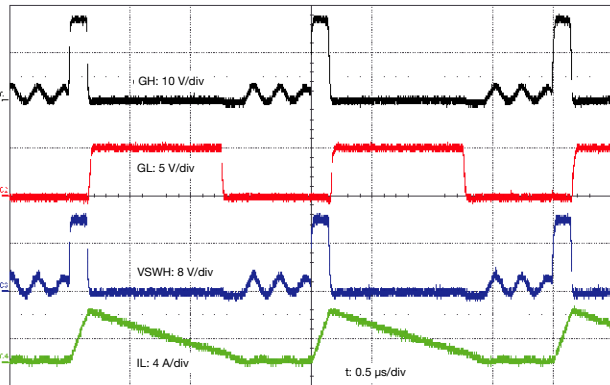

Switching Waveforms with SMOD Enabled  
 $V_{IN} = 12\text{ V}$ ,  $V_{OUT} = 1.2\text{ V}$ ,  $f_S = 500\text{ kHz}$ ,  $I_{OUT} = 0\text{ A}$

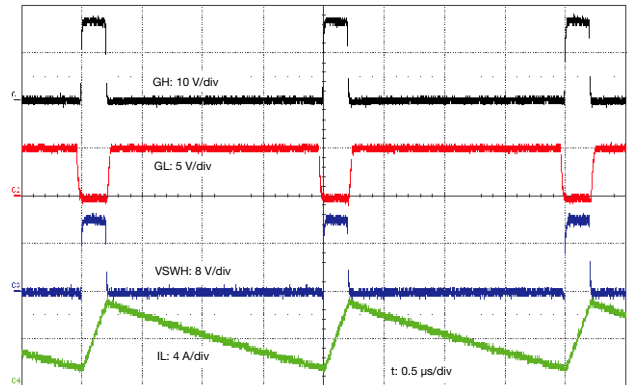

Switching Waveforms with SMOD Disabled  
 $V_{IN} = 12\text{ V}$ ,  $V_{OUT} = 1.2\text{ V}$ ,  $f_S = 500\text{ kHz}$ ,  $I_{OUT} = 4\text{ A}$

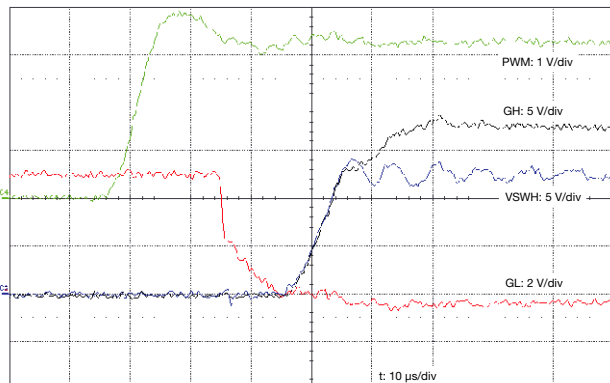

Switching Waveforms at PWM Rising Edge  
 $V_{IN} = 12\text{ V}$ ,  $V_{OUT} = 1.2\text{ V}$ ,  $f_S = 500\text{ kHz}$ ,  $I_{OUT} = 0\text{ A}$

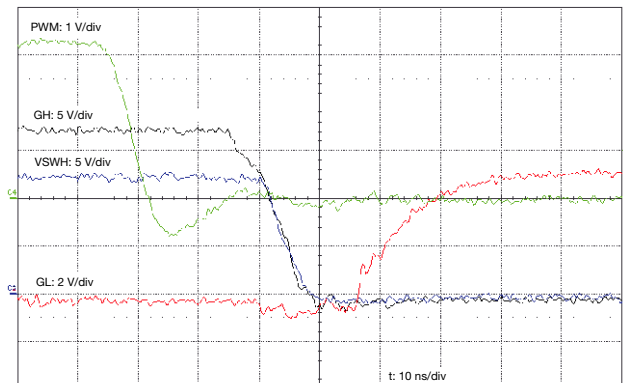

Switching Waveforms at PWM Falling Edge  
 $V_{IN} = 12\text{ V}$ ,  $V_{OUT} = 1.2\text{ V}$ ,  $f_S = 500\text{ kHz}$ ,  $I_{OUT} = 0\text{ A}$

**ELECTRICAL CHARACTERISTICS**

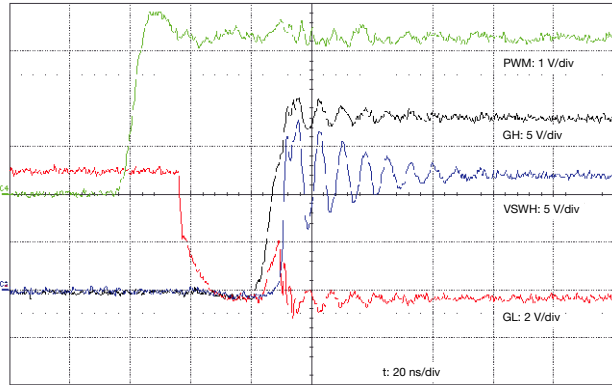

**Switching Waveforms at PWM Rising Edge**  
 $V_{IN} = 12\text{ V}$ ,  $V_{OUT} = 1.2\text{ V}$ ,  $f_s = 500\text{ kHz}$ ,  $I_{OUT} = 30\text{ A}$

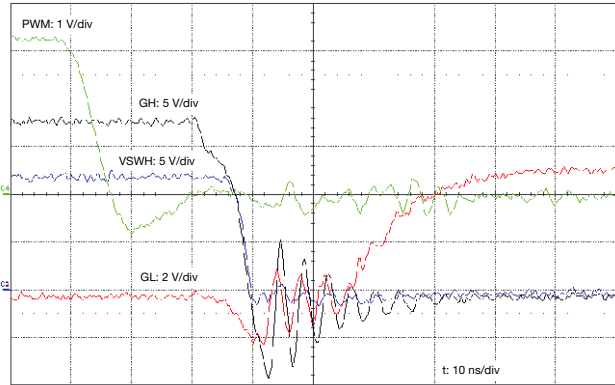

**Switching Waveforms at PWM Falling Edge**  
 $V_{IN} = 12\text{ V}$ ,  $V_{OUT} = 1.2\text{ V}$ ,  $f_s = 500\text{ kHz}$ ,  $I_{OUT} = 30\text{ A}$

**TYPICAL POWER LOSS IN SiC769ACD PowerPAK MLP66-40 PACKAGE**

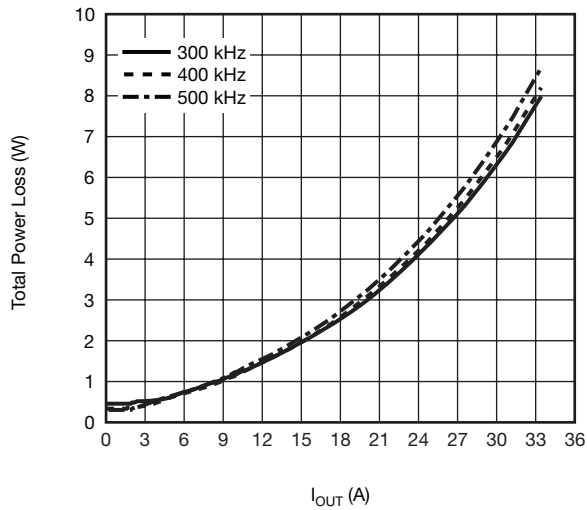

$V_{IN} = 12\text{ V}$ ,  $V_{OUT} = 1.2\text{ V}$ ,  $V_{DRV} = V_{CIN} = 5\text{ V}$ ; No Air Flow  
IHLP5050FDERR33M01 Inductor  
 $L = 330\text{ nH}$ ,  $DCR = 0.83\text{ m}\Omega$

**Figure 6 - Total Power Loss**

**TYPICAL EFFICIENCY CURVES**

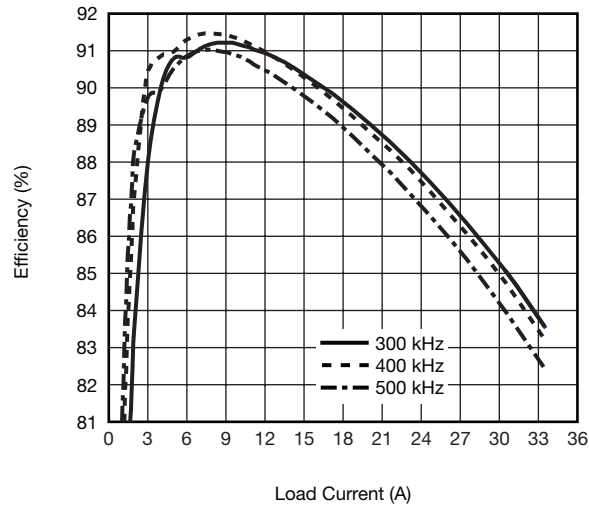

$V_{IN} = 12\text{ V}$ ,  $V_{OUT} = 1.2\text{ V}$ ,  $V_{DRV} = V_{CIN} = 5\text{ V}$ ; No Air Flow  
 IHLP5050FDERR33M01 Inductor  
 $L = 330\text{ nH}$ ,  $DCR = 0.83\text{ m}\Omega$

**Figure 7 - Efficiency**

### PACKAGE DIMENSIONS

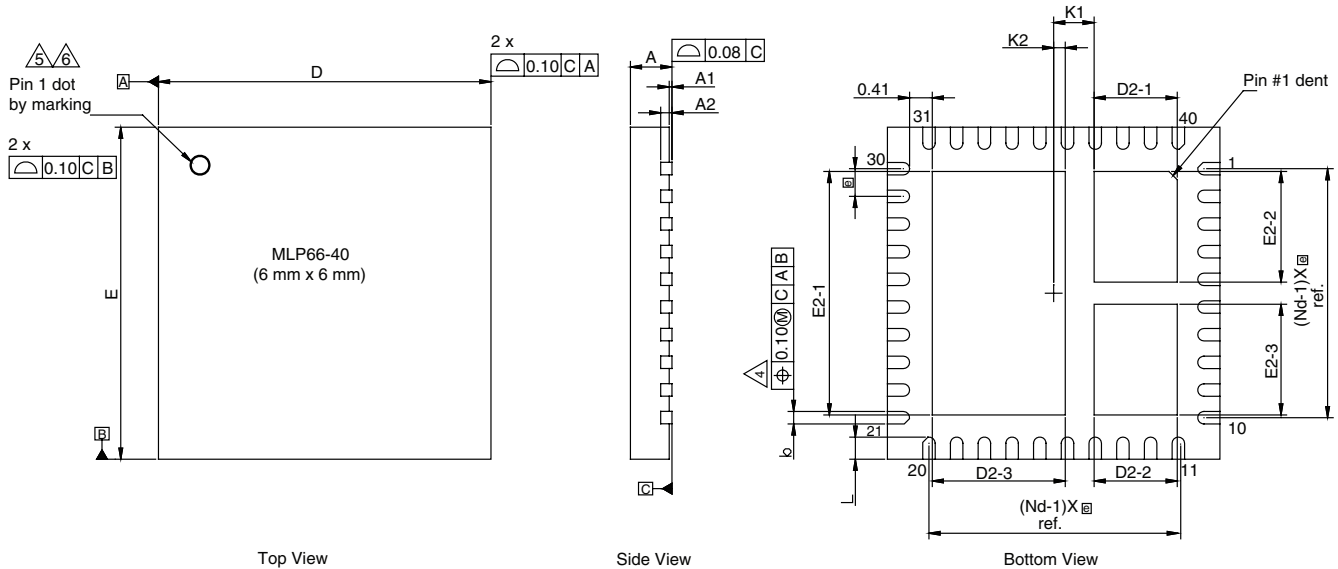

DIM	MILLIMETERS			INCHES		
	Min.	Nom.	Max.	Min.	Nom.	Max.
A <sup>(8)</sup>	0.70	0.75	0.80	0.027	0.029	0.031
A1	0.00	-	0.05	0.000	-	0.002
A2	0.20 ref.			0.008 ref.		
b <sup>(4)</sup>	0.20	0.25	0.30	0.078	0.098	0.111
D	6.00 BSC			0.236 BSC		
$\square$	0.50 BSC			0.019 BSC		
E	6.00 BSC			0.236 BSC		
L	0.35	0.40	0.45	0.013	0.015	0.017
N <sup>(3)</sup>	40			40		
Nd <sup>(3)</sup>	10			10		
Ne <sup>(3)</sup>	10			10		
D2-1	1.45	1.50	1.55	0.057	0.059	0.061
D2-2	1.45	1.50	1.55	0.057	0.059	0.061
D2-3	2.35	2.40	2.45	0.095	0.094	0.096
E2-1	4.35	4.40	4.45	0.171	0.173	0.175
E2-2	1.95	2.00	2.05	0.076	0.078	0.080
E2-3	1.95	2.00	2.05	0.076	0.078	0.080
K1	0.73 BSC			0.028 BSC		
K2	0.21 BSC			0.008 BSC		

Notes:

- Use millimeters as the primary measurement.
- Dimensioning and tolerances conform to ASME Y14.5M-1994.
- N is the number of terminals.  
Nd is the number of terminals in X-direction and Ne is the number of terminals in Y-direction.
- Dimension b applies to plated terminal and is measured between 0.20 mm and 0.25 mm from terminal tip.
- The pin #1 identifier must be existed on the top surface of the package by using indentation mark or other feature of package body.
- Exact shape and size of this feature is optional.
- Package warpage max. 0.08 mm.
- Applied only for terminals.

**LAND PATTERN DIMENSIONS**

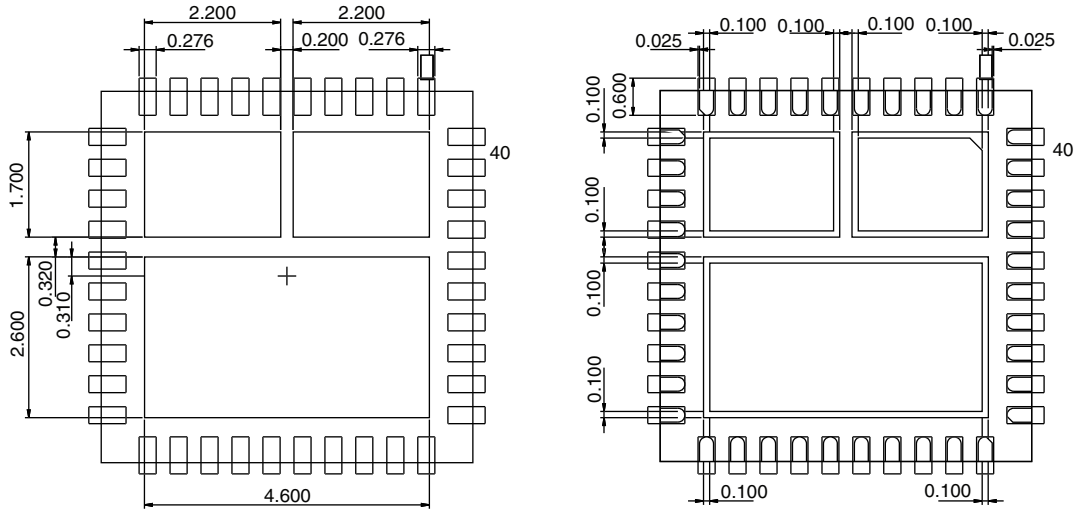

**Figure 8 - PowerPAK MLP 66-40**

**TAPE AND REEL CARRIER TAPE DIMENSIONS**

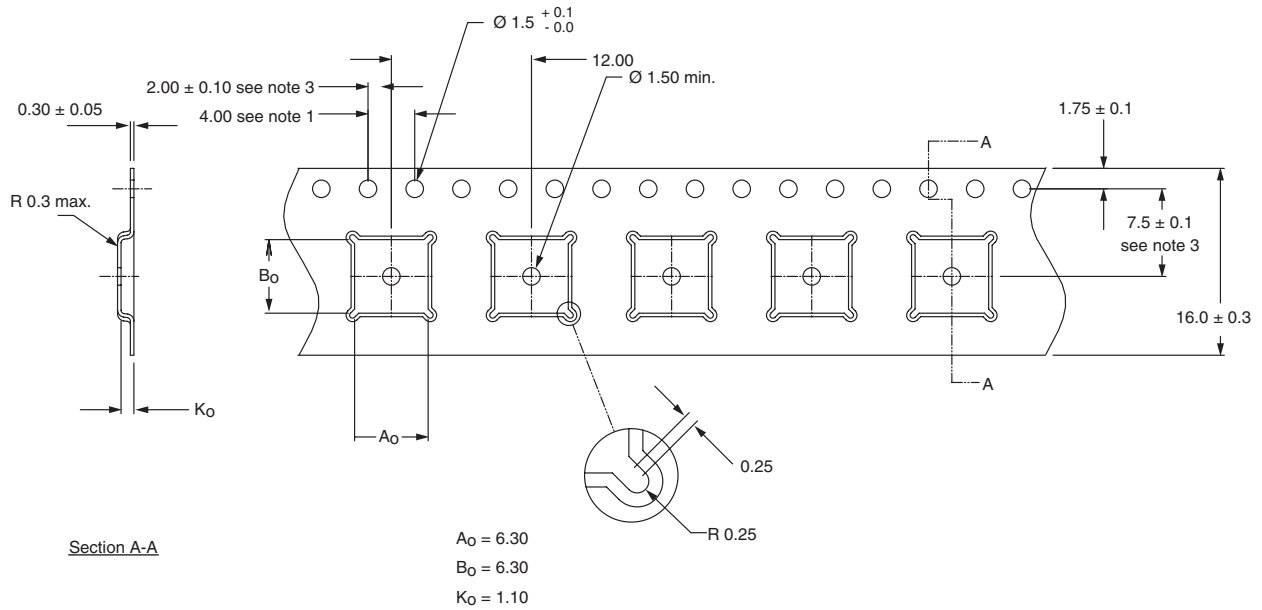

**Notes:**

1. 10 sprocket hole pitch cumulative tolerance  $\pm 0.2$ .
2. Camber in compliance with EIA 481.
3. Pocket position relative to sprocket hole measured as true position of pocket, not pocket hole.

**Figure 9 - PowerPAK MLP 66-40**

Vishay Siliconix maintains worldwide manufacturing capability. Products may be manufactured at one of several qualified locations. Reliability data for Silicon Technology and Package Reliability represent a composite of all qualified locations. For related documents such as package/tape drawings, part marking, and reliability data, see [www.vishay.com/ppg?65708](http://www.vishay.com/ppg?65708).



## PowerPAK® MLP66-40 CASE OUTLINE

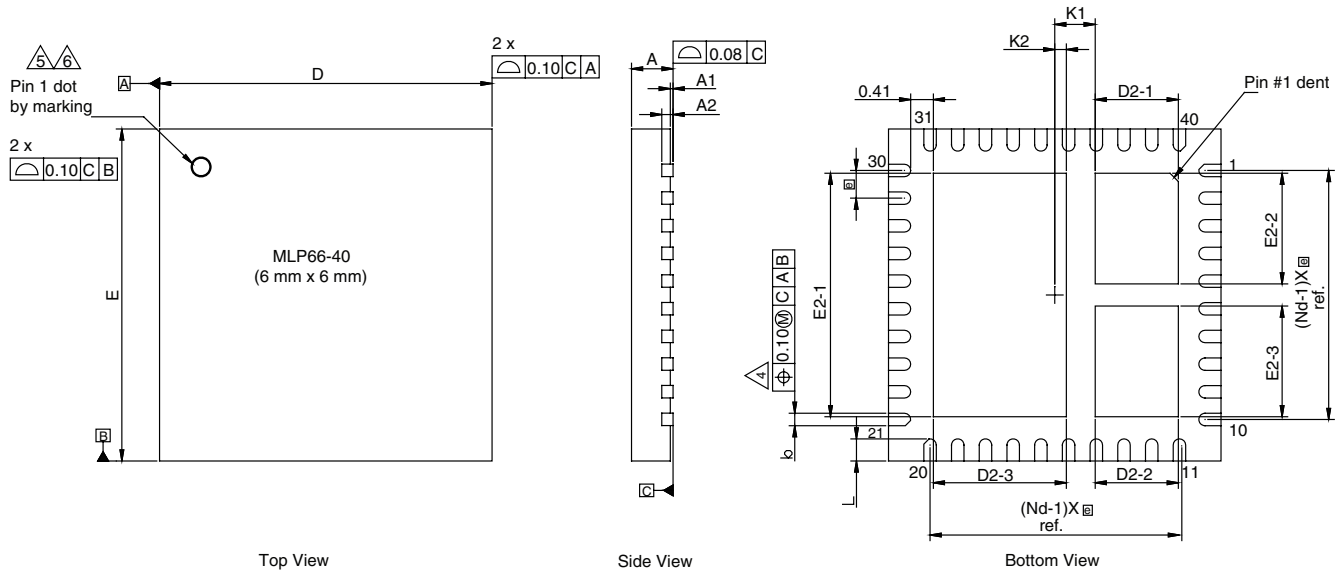

DIM.	MILLIMETERS			INCHES		
	MIN.	NOM.	MAX.	MIN.	NOM.	MAX.
A <sup>(8)</sup>	0.70	0.75	0.80	0.027	0.029	0.031
A1	0.00	-	0.05	0.000	-	0.002
A2	0.20 ref.			0.008 ref.		
b <sup>(4)</sup>	0.20	0.25	0.30	0.078	0.098	0.011
D	6.00 BSC			0.236 BSC		
$\square$	0.50 BSC			0.019 BSC		
E	6.00 BSC			0.236 BSC		
L	0.35	0.40	0.45	0.013	0.015	0.017
N <sup>(3)</sup>	40			40		
Nd <sup>(3)</sup>	10			10		
Ne <sup>(3)</sup>	10			10		
D2-1	1.45	1.50	1.55	0.057	0.059	0.061
D2-2	1.45	1.50	1.55	0.057	0.059	0.061
D2-3	2.35	2.40	2.45	0.095	0.094	0.096
E2-1	4.35	4.40	4.45	0.171	0.173	0.175
E2-2	1.95	2.00	2.05	0.076	0.078	0.080
E2-3	1.95	2.00	2.05	0.076	0.078	0.080
K1	0.73 BSC			0.028 BSC		
K2	0.21 BSC			0.008 BSC		

ECN: T09-0195-Rev. A, 04-May-09  
DWG: 5986

### Notes

1. Use millimeters as the primary measurement
2. Dimensioning and tolerances conform to ASME Y14.5M. - 1994
3. N is the number of terminals. Nd is the number of terminals in X-direction and Ne is the number of terminals in Y-direction
4. Dimension b applies to plated terminal and is measured between 0.20 mm and 0.25 mm from terminal tip
5. The pin #1 identifier must be existed on the top surface of the package by using indentation mark or other feature of package body
6. Exact shape and size of this feature is optional
7. Package warpage max. 0.08 mm
8. Applied only for terminals



## Disclaimer

ALL PRODUCT, PRODUCT SPECIFICATIONS AND DATA ARE SUBJECT TO CHANGE WITHOUT NOTICE TO IMPROVE RELIABILITY, FUNCTION OR DESIGN OR OTHERWISE.

Vishay Intertechnology, Inc., its affiliates, agents, and employees, and all persons acting on its or their behalf (collectively, "Vishay"), disclaim any and all liability for any errors, inaccuracies or incompleteness contained in any datasheet or in any other disclosure relating to any product.

Vishay makes no warranty, representation or guarantee regarding the suitability of the products for any particular purpose or the continuing production of any product. To the maximum extent permitted by applicable law, Vishay disclaims (i) any and all liability arising out of the application or use of any product, (ii) any and all liability, including without limitation special, consequential or incidental damages, and (iii) any and all implied warranties, including warranties of fitness for particular purpose, non-infringement and merchantability.

Statements regarding the suitability of products for certain types of applications are based on Vishay's knowledge of typical requirements that are often placed on Vishay products in generic applications. Such statements are not binding statements about the suitability of products for a particular application. It is the customer's responsibility to validate that a particular product with the properties described in the product specification is suitable for use in a particular application. Parameters provided in datasheets and/or specifications may vary in different applications and performance may vary over time. All operating parameters, including typical parameters, must be validated for each customer application by the customer's technical experts. Product specifications do not expand or otherwise modify Vishay's terms and conditions of purchase, including but not limited to the warranty expressed therein.

Except as expressly indicated in writing, Vishay products are not designed for use in medical, life-saving, or life-sustaining applications or for any other application in which the failure of the Vishay product could result in personal injury or death. Customers using or selling Vishay products not expressly indicated for use in such applications do so at their own risk. Please contact authorized Vishay personnel to obtain written terms and conditions regarding products designed for such applications.

No license, express or implied, by estoppel or otherwise, to any intellectual property rights is granted by this document or by any conduct of Vishay. Product names and markings noted herein may be trademarks of their respective owners.

## Material Category Policy

**Vishay Intertechnology, Inc. hereby certifies that all its products that are identified as RoHS-Compliant fulfill the definitions and restrictions defined under Directive 2011/65/EU of The European Parliament and of the Council of June 8, 2011 on the restriction of the use of certain hazardous substances in electrical and electronic equipment (EEE) - recast, unless otherwise specified as non-compliant.**

**Please note that some Vishay documentation may still make reference to RoHS Directive 2002/95/EC. We confirm that all the products identified as being compliant to Directive 2002/95/EC conform to Directive 2011/65/EU.**

**Vishay Intertechnology, Inc. hereby certifies that all its products that are identified as Halogen-Free follow Halogen-Free requirements as per JEDEC JS709A standards. Please note that some Vishay documentation may still make reference to the IEC 61249-2-21 definition. We confirm that all the products identified as being compliant to IEC 61249-2-21 conform to JEDEC JS709A standards.**