



Chipsmall Limited consists of a professional team with an average of over 10 year of expertise in the distribution of electronic components. Based in Hongkong, we have already established firm and mutual-benefit business relationships with customers from,Europe,America and south Asia,supplying obsolete and hard-to-find components to meet their specific needs.

With the principle of “Quality Parts,Customers Priority,Honest Operation,and Considerate Service”,our business mainly focus on the distribution of electronic components. Line cards we deal with include Microchip,ALPS,ROHM,Xilinx,Pulse,ON,Everlight and Freescale. Main products comprise IC,Modules,Potentiometer,IC Socket,Relay,Connector.Our parts cover such applications as commercial,industrial, and automotives areas.

We are looking forward to setting up business relationship with you and hope to provide you with the best service and solution. Let us make a better world for our industry!



Contact us

Tel: +86-755-8981 8866 Fax: +86-755-8427 6832

Email & Skype: info@chipsmall.com Web: www.chipsmall.com

Address: A1208, Overseas Decoration Building, #122 Zhenhua RD., Futian, Shenzhen, China



SERIOUS™

SIM231

Technical Reference Manual



IMPORTANT LEGAL NOTICE

See the latest and complete warranty, licensing and legal information at www.seriousintegrated.com/legal.

Information herein is provided in connection with Serious Integrated, Inc. ("SERIOUS") products.

The products may comprise components designed and manufactured by SERIOUS as well as other vendors. This information may refer to a variety of specifications related to those non-SERIOUS components for informational purposes only, and the user is strongly urged to consult the original manufacturers' data sheets and other documentation for authoritative specifications.

No license, express or implied, by estoppel or otherwise, to any intellectual property rights is granted by this information.

SERIOUS assumes no liability whatsoever, and SERIOUS disclaims any warranties whether express or implied, written, oral, statutory or otherwise relating to the information and its use, including any liability for warranties relating to fitness for a particular purpose, performance, quality, merchantability, or noninfringement of any patent, copyright or other intellectual property right. The user is responsible for determining the suitability of SERIOUS products for the intended application and that applicable specifications are met.

SERIOUS makes no representations or warranties with respect to the accuracy or completeness of the information and may make changes to the information, specifications and product descriptions at any time without notice. Designers should not rely on the absence or characteristics of any features or instructions marked "reserved" or "undefined." SERIOUS reserves these for future definition and shall have no responsibility whatsoever for conflicts or incompatibilities arising from future changes to such features or instructions. SERIOUS products may contain design defects or errors known as errata which may cause the product to deviate from published specifications. Current characterized errata are available upon request.

Use of SERIOUS products in automotive, military, aircraft, space, life-saving or life-sustaining applications or in any systems where failure or malfunction may result in personal injury, death or severe property or environmental damage is entirely at the buyer's risk and the buyer agrees to defend, indemnify and hold harmless SERIOUS from any and all damages, claims, suits or expenses resulting from such use.

TRADEMARKS AND COPYRIGHTS

The "Serious" name and stylized Serious mark are trademarks of Serious Integrated, Inc. The information herein, unless otherwise indicated, is Copyright 2013-2014 Serious Integrated, Inc.

Third party brands and names are the property of their respective owners.

CONTENTS

IMPORTANT LEGAL NOTICE	2
TRADEMARKS AND COPYRIGHTS	2
Document Information and Applicable Products	6
Change History and Applicable Products.....	6
Document Conventions	6
Introduction	7
Usage Models	7
Hardware	8
Software	8
Getting started	9
Ordering Information.....	10
Order Codes.....	10
Variant Options.....	11
LCD Options	12
Development Kits	13
Specifications	14
DC Maximum Ratings	14
DC Operating Characteristics.....	14
Module Level.....	14
By Subsystem	15
MCU I/O	15
AC Timing Characteristics	15
Environmental Characteristics.....	16
Handling and Care	16
Handling.....	16
Pressure and Impact	17
Storage	17
Cleaning.....	17
Physical Characteristics	18
Alignment and Mounting Holes	18
LCD Dimensions and Bezel Size.....	19
Module Weight	19

Daughter Card Physical Guidelines.....	20
Serious Communications Modules	22
Hardware Overview	23
High Performance Renesas RX63N/631 MCU.....	23
Graphic Color LCD Display and Touch Option.....	23
<i>Serious</i> Gatling™ Technology.....	24
On-Module Peripherals	24
On-Module Memory.....	24
Communications and Connectors	24
Power.....	25
Module Feature Detail	26
Renesas RX63N/RX631 MCU	26
MCU Boot Modes and the USB Boot FLASH.....	26
LCD Display	28
Graphics Controller	28
Touch Controller	28
Proximity Sensing.....	29
Ambient Light Sensing.....	29
Power Supplies	30
Power Input: +VIN_MAIN	30
Power Input: +VEXT	30
Turning SIM231 Off: PWRDWN#	30
+3.3V (+3V3) Regulation	31
+5V_USB F:USB Device (“Function”) Power	31
+5V_USB H: USB Host Power.....	31
LCD Panel Backlight Power: P11-BLEN and BL_LED+/BL_LED-	32
Battery Backed Real Time Clock/Calendar (RTCC): +VBAT	32
Memory	33
Serial FLASH	33
SDRAM	34
EEPROM	34
Serious Serial Number	34
Cryptographic/Authentication device	35

Clocks, Oscillators, and Time Keeping	36
High Speed (12 MHz) Clock	36
MCU Real-Time Clock/Calendar (RTCC)	36
External RTCC with Optional Battery Backup.....	36
Audio	37
Piezo Sounder	37
10-bit Single Channel DAC	38
User LED.....	38
I2C Device Summary	38
Interrupt Summary	38
Connectors.....	39
SHIP Programming Port.....	39
Tag-Connect JTAG Port	40
16-pin Power/Communications Connector	40
USB Micro B Device Connector	42
USB A Host Connector.....	42
60-pin Expansion Connector	42
Universal Serial Bus (USB).....	44
Device IDs.....	44
USB Software	45
USB2.0 Full-Speed Device Port.....	45
USB2.0 Full Speed Embedded Host Port	45
Additional Information	46

DOCUMENT INFORMATION AND APPLICABLE PRODUCTS

CHANGE HISTORY AND APPLICABLE PRODUCTS

The following table summarizes major changes to this document and the applicable versions of the product corresponding to this document:

Doc Version	Date	For HW Versions	Major Changes
A0	23 Sep 13	1.0	<ul style="list-style-type: none"> ▶ Initial prerelease version
A1	27 Sep 13	1.0	<ul style="list-style-type: none"> ▶ First internal scrub; alpha customer ready
B0	20 Jan 14	2.0	<ul style="list-style-type: none"> ▶ Updated for pre-production v2.0 units <ul style="list-style-type: none"> ▶ Removed PCB Edge connector ▶ Added Tag-Connect for JTAG ▶ Added new SHIP Programming Port ▶ Removed haptic option ▶ Finalized LCD specification for initial MVA LCD options ▶ Added LCD 24-bit support notes ▶ USB device connector changed from mini to micro ▶ Added references to SCM117
B1	19 Jun 14	2.0	<ul style="list-style-type: none"> ▶ Moved BLEN from P11 to P24 for production; PWM capable ▶ Added Dev Kit description/section ▶ Added Care and Handling section ▶ Expanded Daughter Card guidelines ▶ Expanded Physical Characteristics and mechanical guidelines ▶ Updated/Clarified daughter card mirror pin-out ▶ Added backlight power, next rev will have full power characterization data
B2	20 Aug 14	2.0	<ul style="list-style-type: none"> ▶ Fixed Glass Codes; should have been 0x01, not 0x00

DOCUMENT CONVENTIONS



This symbol indicates an advanced tip for hardware or software designers to extract interesting or unique value from the Serious Integrated Module.



Pay special attention to this note – items especially subject to change, or related to compatibility, functionality, and usage.



WARNING: You can damage your board, damage attached systems, overheat or cause things to catch fire if you do not heed these warnings.



Notes with this symbol are related to license and associated legal issues you need to understand to use this software. We're big believers in honoring license agreements, so please help the industry by respecting intellectual property ownership.



Some hardware features may be preconfigured or permanently reserved for use by the [SHIPEngine](#) software (the GUI management engine component of the [Serious Human Interface™ Platform](#)). Notes with this symbol indicate where the module comes pre-configured or uses these resources.

INTRODUCTION

The SIM231 family of *Serious Integrated Modules* is a series of complete intelligent 3.5" QVGA graphic front panels, some with resistive touch capability.

The SIM231 family incorporates *Serious Gatling™ Technology* for rapid-fire delivery of pixels to the display with minimal CPU overhead while retaining the cost-effective elements of a solution without a dedicated hardware graphics controller. Using this technology, the SIM231 can deliver 16 or 24 bit color frames to the LCD with little CPU and SDRAM bandwidth required.

These cost-effective modules are designed for use by Original Equipment Manufacturers (OEMs), custom design shops, and hobbyists to add sophisticated and user-friendly graphical user interfaces to their products.

USAGE MODELS

In most cases, you will be adding a SIM to a system that already has an MCU, I/O, power conditioning, and other custom interfaces. Perhaps your system already has a membrane keypad and a 2x16 character display or indicator LEDs. Your current MCU software in your existing system controller manages all aspects of your device, including (as applicable) belts, pumps, motors, servos, indicators, etc.

Rather than completely redesigning the hardware and software of your existing system to create a merged hardware/software architecture (LCD front panel plus system controller all-in-one), it is far more common to partition the problem by retaining your existing system controller and software and using the SIM as an intelligent stand-alone front panel.

Therefore SIMs typically most often used as stand-alone front panels responsible for managing just the Human Machine Interface (HMI) in a larger system. The existing, separate, device-specific system controller continues to manage the main functionality of the system. SIMs are equipped with several methods for simple interconnect to the external system controller, getting power from that external system, and communicating via a serial type link (SPI, UART, USB) to that controller to exchange data and commands.

Using the *Serious Human Interface™ Platform (SHIP)*, the software team can leverage the power of the *SHIPTide* rapid GUI development tools from *Serious*, developing a user interface in as little as a few hours and a few dozen lines of code. The *SHIPEngine* runtime firmware pre-installed on all SIMs takes care of all the drivers, rendering, communications, and event handling for the user interface, leaving the GUI development process to be focused on look and feel and differentiation of your device. You never need to write C code or use a JTAG debugger with a SIM to develop a modern-looking user interface.



SHIP software and development tools are available at no-cost for users of Serious Integrated Modules. See www.seriousintegrated.com/SHIP for details.

Adding a simple software protocol driver to your system controller on the other end of the communications link allows your controller to communicate with the front panel. You can then architect inter-board messages such as “pump is on” which could be sent over the UART/SPI/etc. causing visual indicators to appear or change on the display. A GUI on the SIM231 could change user preferences, for instance, sending back messages such as “pump on days: MWF” which the system controller may store in its configuration EEPROM.

The possibilities are endless: the SIM231 module contains not only a powerful MCU but also a suite of hardware features that are commonly needed in many designs. An alarm panel, for example, could be as simple as a SIM231 connected to another PCB with a \$0.20 MCU, a few relays and a battery.

HARDWARE

SIM231 family features include:

- ▶ 4.3" WQVGA 480x272 [color TFT display](#)
 - Various touch panel options, including 4-wire resistive with proximity detection
 - Color depths from 16 to 24-bit
 - [Serious Gatling™ Technology](#) for rapid-fire pixel delivery to the LCD with minimal CPU intervention
- ▶ 100MHz 32-bit [Renesas RX631/RX63N MCU](#)
 - 128KB RAM, 512KB-2MB FLASH
 - Integrated temp sensor & RTCC
 - Ethernet RMII available on expansion connector on some variants
- ▶ On-module memory
 - 8-16MB [SDRAM](#)
 - 8-16MB [serial FLASH](#) + [4kbit EEPROM](#)
- ▶ Extensive I/O
 - [60-pin Expansion Connector](#) (GPIO, +5V, RESET#, I2C, SPI, UART; RMII on 63N-based units)
 - *Serious* system-to-system [16-pin Power/Communications Connector](#)
 - [SHIP Programming Port](#) for rapid GUI/Firmware programming
 - [USB Micro B Device Connector](#)
 - [USB A Host Connector](#)
 - [Tag-Connect JTAG Port](#)
- ▶ PCB operating temperatures as wide as -40 to 85°C; [LCD option](#) may restrict operating range.

Within the SIM231 are numerous family members, or “variants”. Each variant has a slightly different set of features and price points for an OEM to select the appropriate feature/cost point for their specific application. Consult the [Variant Table](#) for more information. In addition to these different functional variants, various [LCD options](#) are available.

SOFTWARE

Developing a complete graphic user interface (GUI) can be a complex, time consuming, and expensive endeavor. Often tens of thousands of lines of custom C code need to be developed in conjunction with custom hardware drivers and off-the-shelf libraries. For rapid GUI development, the [Serious Human Interface™ Platform](#) offers PC-based GUI design tools and rapid GUI prototyping, development, and deployment. With minimal coding you can create attractive and functional GUIs in a fraction of the time of C-based development.



SHIP software and development tools are available at no-cost for users of Serious Integrated Modules. See www.seriousintegrated.com/SHIP for details.

The SIM231 is also supported by a growing collection of Renesas, open source, as well as *Serious* proprietary software, allowing designers to gain confidence that their essential software can not only get it done, but perform to the needed end result. Available at mySerious.com for download, SIM231 programmers can obtain an out-of-the-box experience with pre-ported versions of the [Micrium uCOS-III](#), [Segger embOS](#) and [FreeRTOS](#) operating systems. The SIM231 includes full single-unit production licenses of the Micrium and Segger kernels for use with each module.

It is very difficult to know, as a designer selecting the hardware for a graphic/touch interface, if the result after many months of software and graphic design will have acceptable performance. Will the system be responsive? Will it be visually attractive? Will the look-and-feel be consistent with the company’s brand image? *Serious* addresses these OEM designer challenges by delivering video best-of-class GUI examples, fostering community demos and solutions, and providing software, tools, and consulting services.

GETTING STARTED

The SIM231 comes pre-configured with a SHIP demo loaded into the in the RX MCU and serial FLASH.

If your SIM variant has a USB Micro B connector present, your SIM can be powered from any PC's USB port or USB hub with 500mA power capability.

Alternatively if you have purchased a development kit containing a [SHIP Programming Adapter 200 \(SPA200\)](#) and [SHIP Programming Connector SPC200](#), you can plug the SPA200/SPC200 combination into the [SHIP Programming Port](#) with the SPA200 powered from a PC USB port, hub, or even a stand-alone USB AC power adapter.



Several connectors may be used to power the SIM231. See [Power Supplies](#).

The demo will start running and displaying info on the LCD screen. For more getting started information and out-of-the-box tips, see www.seriousintegrated.com/oob.

ORDERING INFORMATION

Consult an [authorized Serious representative](#) for an up-to-date listing of order codes, family variants, and LCD options available.



This document version contains prerelease information prior to product introduction and is subject to change.

ORDER CODES

SIM order codes are constructed as follows:

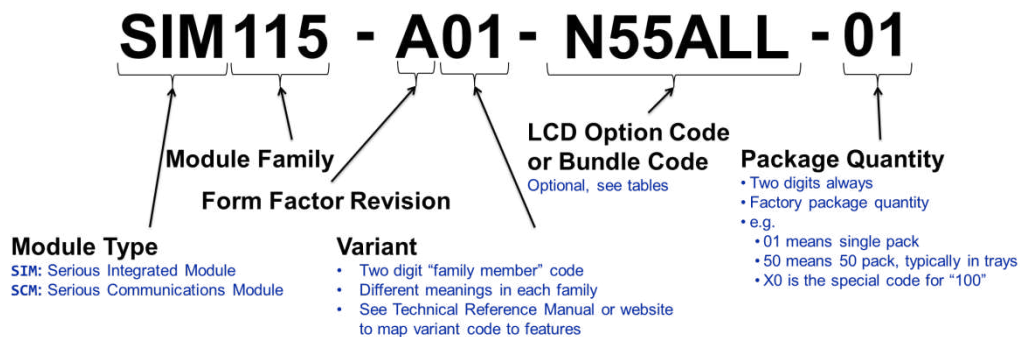











As of the time of this document's publish date, the current order codes are as follows:

Order Code	Description	Detail	Pkg Qty
SIM231-A01-DEV- 01	Dev Kit SIM231-A01-R32ALM w/SPA200-A00, Cables, Acrylic Case	Includes SHIP Programming Adapter kit. No JTAG debugger/adapter included.	1
SIM231-A01-R32ALM-01	Color Graphic LCD Module	RX63N 768/128, 16MB DRAM, 16MB SFLASH, USB Device+Host, Piezo, RTCC, Prox, AmbLight	1
SIM231-A01-R32ALM-10	4.3" WQVGA w/Serious Gatling™ Technology		10
SIM231-A01-R32ALM-50	Res Touch, Full Featured		50
SIM231-A02-N32ALM-01	Color Graphic LCD Module	RX63N 768/128, 16MB DRAM, 16MB SFLASH, USB Device+Host, Piezo, RTCC, AmbLight	1
SIM231-A02-N32ALM-10	4.3" WQVGA w/Serious Gatling™ Technology		10
SIM231-A02-N32ALM-50	No Touch, Full Featured		50
SIM231-A03-R32ALM-01	Color Graphic LCD Module	RX631 512/128, 8MB DRAM, 8MB SFLASH, Prox, AmbLight	1
SIM231-A03-R32ALM-10	4.3" WQVGA w/Serious Gatling™ Technology		10
SIM231-A03-R32ALM-50	Res Touch, Low Cost		50
SIM231-A04-N32ALM-01	Color Graphic LCD Module	RX631 512/128, 8MB DRAM, 8MB SFLASH, AmbLight	1
SIM231-A04-N32ALM-10	4.3" WQVGA w/Serious Gatling™ Technology		10
SIM231-A04-N32ALM-50	No Touch, Low Cost		50

For a detailed explanation of LCD Option Codes, consult the [Serious website](#).

VARIANT OPTIONS

As of the time of this document's publish date, the variants (aka family members) are:

Family Variant	A01	A02	A03	A04
MCU				
MCU	RX63N	RX63N	RX631	RX631
MCU Max MHz	100	100	100	100
MCU FLASH/RAM(kB)	768/128	768/128	512/128	512/128
JTAG E1 Debug	⊙⊙	⊙⊙	⊙⊙	⊙⊙
Memory				
SDRAM (MB)	16	16	8	8
Serial FLASH (MB)	2x8	2x8	8	8
EEPROM	✓	✓	✓	✓
LCD & Touch				
<i>Serious</i> Gatling™ Technology	✓	✓	✓	✓
Touch	R4		R4	
Capacitive Proximity Sensor	✓		✓	
Ambient Light Sensor	✓	✓	✓	✓
Peripherals & GPIO				
User Red/Green/Orange LED	✓	✓		
PCB Temp Sensor	✓	✓		
Piezo Sounder	✓	✓		
32.768kHz Clock/Calendar	PCF8523	PCF8523	MCU	MCU
USB 2.0 FS device circuitry				
USB 2.0 FS host circuitry				
Expansion Connectors				
USB 2.0 FS device Micro-B connector	✓	✓		
USB 2.0 FS host A connector	✓	✓		
60-pin Board-to-Board Expansion Connector Power, I2C, SPI, UART, DAC, RMII (w/RX63N)	✓	✓	✓	✓
16-pin <i>Serious</i> Power/Comms Connector Power, I2C, SPI, UART	✓	✓	✓	✓
Power				
Power Input (5V typical)				
CR1025 coin cell holder for RTCC backup	✓	✓		

- ⊙ on [16-pin Power/Communications Connector](#)
- on [60-pin Expansion Connector](#)
- ⊙ on [Tag-Connect JTAG Port](#)
- S on [SHIP Programming Port](#)
-  on [USB A Host Connector](#)
-  on [USB Micro B Device Connector](#)



This table contains prerelease information prior to product introduction and is subject to change.

LCD OPTIONS

Consult the following table for available LCD Options on the SIM231 family at the time of this document release. Not all LCD options are available for all variants: for an up-to-date list, contact an [authorized Serious representative](#). For a detailed explanation of LCD Option Codes, consult the [Serious website](#).

LCD Option Code Serial Number Byte ¹	R32ALM 0x01	N32ALM 0x01
Size (diagonal, active, inches)	4.3	4.3
Size (diagonal, active, inches)	4.3	4.3
Resolution	480x272	480x272
Touch	R4	
NITs (min typ)	300+	300+
Backlight Life (min typ, hours)	20k	20k
Viewing Technology	Multi-Viewing Angle (MVA)	Multi-Viewing Angle (MVA)
Viewing Angles (min typ)	75°	75°
Proximity Detect Capable	✔	
Color Depth (bits)	16/24	16/24
Operating Temp Range	-20 ² to +70C ³	-20 ³ to +70 ³ C
Storage Temp Range	-30 to +80C	-30 to +80C
On-glass RAM	0	0
Active Area (mm W x mm W)	95.04 x 53.86	95.04 x 53.86
Pixel Pitch (µm W x µm H)	198 x 198	198 x 198
Backlight Power (min typ/max typ @100%, mW)	640/660 ⁴	640/660 ⁴

Notes: ¹See [Serious Serial Number](#)

²LCD will become slightly sluggish at low temperatures below -10C

³LCD will become darker near the high end of the temperature range

⁴LCD power at the backlight; SIM boost converter inefficiencies increase this at a module level; see [DC Operating Characteristics](#)

Note that the PCB, MCU, and associated components may be rated for a larger operating temperature range than the LCD. In this case, the MCU will operate correctly over the entire operating range however the LCD may not function or be visible outside its specified operating range. In all cases, the narrower of the two recommended storage temperature ranges (PCB and LCD) should not be exceeded.

DEVELOPMENT KITS

The [SIM231-A01-DEV-01](#) development kit contains everything needed to develop with, and production program, all members of the SIM231family.



Some variants of the SIM231, such as the SIM231-A03 and –A04, have no USB device connector populated – **you must have a SPA200** (included in the development kit) **to be able to program and update these modules.**



The SIM231 is primarily intended for GUI development with the [Serious Human Interface™ Platform](#) therefore the standard development kit has no JTAG debugger included. To develop in C, you must purchase separately:

- ▶ a JTAG debugger, such as a [Segger J-Link](#) with [J-Link RX Adapter](#) or Renesas E1
- ▶ a [Tag-Connect TC2070](#) adapter cable and retention clips

The kit contains:

- ▶ [SIM231-A01-R32ALM](#) module
 - ▶ Superset of all SIM231 features
 - ▶ Bright 300+ NIT Resistive Touch Multi Viewing Angle LCD with proximity and ambient light detection
- ▶ [SHIP Programming Adapter 200 \(SPA200\) Kit](#)
 - ▶ [SHIP Programming Adapter 200 \(SPA200\) intelligent rapid-programming unit for development and high-volume production use](#)
 - ▶ [SHIP Programming Connector 200 \(SPC200\)](#) to connect the SPA200 to all newer SIMs, including [SIM115](#), [SIM231](#), and [SIM535](#)
 - ▶ All cables necessary to connect the PC to the SPA200, the SPA200 to SPC200, and SPC200 to the SIM
 - ▶ 5V 12W wall power supply for lab use (110/220VAC EU/US voltage and plug compatibility) powers the SPA and optionally powers the SIM as well
- ▶ 16 pin wire harness (JST16 plug one end, tinned the other) for lab cable enabling
- ▶ Acrylic “enclosure” for safe handling and demonstration use



The [SPA200](#) and [SPC200](#) are set for release in Q3 2014; Development kits shipped prior to this release will include a mail-in coupon for these.



This is a preliminary table (prior to product release) and is subject to change.

SPECIFICATIONS

DC MAXIMUM RATINGS

The following are absolute maximum limits for the specified variants:

Specification	Variant	DC Limits			Units
		Min	Typ	Max	
Input Supply Voltage +VEXT	A01	4.50 ¹	5.00	5.25	V
	A02	4.50 ¹	5.00	5.25	V
	A01	3.60 ²	5.00	5.25	V
	A02	3.60 ²	5.00	5.25	V
	A03	3.60	5.00	5.50	V
	A04	3.60	5.00	5.50	V

Notes: ¹USB Host circuit enabled

²USB Host circuit never enabled

DC OPERATING CHARACTERISTICS

MODULE LEVEL

The following DC characteristics apply to all variants of the SIM231:

Specification	LCD Backlight State	USB Host Boost	Range			Units	
			Typ ^{1,2,5}	Typ ^{1,3,5}	Max ^{1,2}		Max ^{1,3}
Input Supply Current +VEXT	RESET		<i>tbd</i>	<i>tbd</i>	<i>tbd</i>	<i>tbd</i>	mW
	off	off	<i>tbd</i>	<i>tbd</i>	<i>tbd</i>	<i>tbd</i>	mW
	100%	off	<i>tbd</i>	<i>tbd</i>	<i>tbd</i>	<i>tbd</i>	mW
	100%	on ⁴	<i>tbd</i>	<i>tbd</i>	<i>tbd</i>	<i>tbd</i>	mW

Notes: ¹Any additional external current draw from the module is in addition to this value

²At minimum voltage on supply

³At typical input supply voltage

⁴No device inserted; device power is in addition to this number plus typical conversion loss of 10-20%.

Numbers in this style are preliminary and pending final characterization.

BY SUBSYSTEM

The amount of power necessary for SIM231 to function is highly dependent on how and which features of the module you use. This is especially true for major power consumers such as the LCD backlight and USB embedded host port. If your application does not enable these features, the typical and maximum power numbers can be appropriately subtracted from the maximums for the SIM respectively. Assuming typical switching conversion efficiency, the power breakdown of the elements is as follows:

Subsystem	Circuit-Local Power Required (mW) ¹			+VEXT to Local Conversion Efficiency (typ)	+VEXT Power Required (mW) ¹		
	Min	Typ	Max		Min	Typ	Max
LCD Backlight							
N32ALM/R32ALM LCD options		640	660	80%	800	825	
LCD Logic		<i>tbd</i> ³	<i>tbd</i> ⁴	92%	<i>tbd</i> ³	<i>tbd</i> ⁴	
Serious Gatling™ Technology		66	100	92%	72	108	
Piezo		3	10	92%	4	11	
MCU		178	370	92%	194	402	
DRAM 8MB or 16MB		200	594	92%	217	645	
SFLASH 8MB or 16MB		33	83	92%	36	90	
Resistive Touch		33	56	92%	36	61	
USB Host		0 ²	750	85%	0 ²	883	
Other logic and miscellaneous		<i>tbd</i>	<i>tbd</i>	92%	<i>tbd</i>	<i>tbd</i>	

- Notes: ¹At typical input supply voltage
²No device inserted; device power is in addition to this number.
³50% white/50% black or 50% RGB pixel intensity
⁴100% white
Numbers in this style are preliminary and pending final characterization.

MCU I/O

Many I/O signals on the SIM231 are directly and exclusively connected to [RX63N/631](#) MCU pins. Consult the [RX63N/631](#) data sheet for complete specifications of each pin.



There are specific power limitations on the MCU pins. Consult the [RX63N/631](#) data sheet for more information. **Exceeding these limits may damage your board, damage attached systems, overheat or cause things to catch fire.**

AC TIMING CHARACTERISTICS

The AC timing characteristics at the module level are governed by the underlying AC timing characteristics of the individual components. Consult the component data sheets for more information.



The no-cost SHIPWare source code as well as the full-featured [Serious Human Interface™ Platform](#) software initializes the MCU and other SIM components for correct operation.

ENVIRONMENTAL CHARACTERISTICS

The following table describes the absolute maximum environmental conditions for the SIM231:

Specification	Variant	Permissible Range			Units
		Min	Typ	Max	
Operating Temperature (not including LCD)	All	-40		+85	C
Storage Temperature (not including LCD)	All	-40		+85	C
Humidity	All			90% below 50C 60% above 50C	RH

 Note that these limits do not include the LCD environmental limits. For example, while the SIM may be able to function over its full operating temperature range, often the LCD temperature range is more restrictive and the LCD may become difficult to read, sluggish, or non-functional outside its limits.

Consult the [LCD Options](#) to determine the operating and storage temperature limits for the LCD selected. In no case should the unit be stored outside the narrower of the Storage Temperature ranges of the SIM and its LCD.

HANDLING AND CARE

Observe the following handling and care guidelines.

HANDLING



Be very careful when handling the edge of the SIM where the flexible cable from the LCD panel is exposed. This can be easily damaged or ripped if shear-force is applied in handling.



Do not attempt to disassemble the module or solder components or wires to the module; this may render your board non-functional and void your warranty.



As with all electronic subsystems and circuits, observe proper ESD handling procedures.



As with any glass product, use reasonable care when handling to avoid glass chips and cracks.





If the LCD glass breaks and the LCD liquid materials escape, avoid contact with bare skin. Wash exposed skin with soap and water immediately and dispose of the product according to local materials handling procedures.



If the SIM comes in factory packaging with a protective cover sheet on the LCD, it is advised to leave this protective film in place until the SIM is mounted in the final assembly to prevent scratches and fingerprints from marring the display surface. Do not expose to high temperature and/or high humidity testing with the protective sheet in place. Slowly remove the protective sheet to minimize potential static electricity creation.

PRESSURE AND IMPACT

-  On non-touch variants apply no pressure, and ensure no impact can be made by end users, to the surface of the LCD display. There is no specification for pressure or impact on non-touch LCDs.
-  On touch variants, do not use sharp objects to activate the touch screen or the overlay material may be damaged.
-  Do not apply any bending/twisting force to the LCD or the SIM PCB or the unit may be permanently damaged.

STORAGE

Follow these basic precautions when storing un-installed SIMs for extended periods:

1. Store SIMs in the original factory packaging whenever possible. The sealed polyethylene antistatic bags or the antistatic trays are designed for long term storage.
2. Store the SIM sub-packs where they will not be subjected to high heat, sunlight, or high humidity conditions. Recommended storage temperatures should be kept between 0C and +40C, with relative humidity below 80%.
3. Desiccant should not be required if properly sealed and room temperature ambient temperatures are maintained.

CLEANING

If cleaning of the LCD panel surface is necessary, Isopropyl or Ethyl alcohol, either 100% or mixed 50%/50% with distilled water, may be used on a moist clean soft cloth.

-  Do not use abrasive, ketone-containing, and aromatic solvents which will damage polarizer materials.

PHYSICAL CHARACTERISTICS

The outer dimensions of the SIM231 are approximately 121.6mm x 67.3mm. Note that for those variants with USB Micro B and/or USB A connectors populated, these connectors extend approximately 2mm beyond this width. The depth of the module depends on the variant. For example, variants with resistive touch screens have the cover glass and touch layer on the LCD that increase depth by over 1mm. Also, various connectors such as the USB A connector, if populated, change the mechanical dimensions. An example of the SIM231-A01-R32ALM module dimensions are shown here:

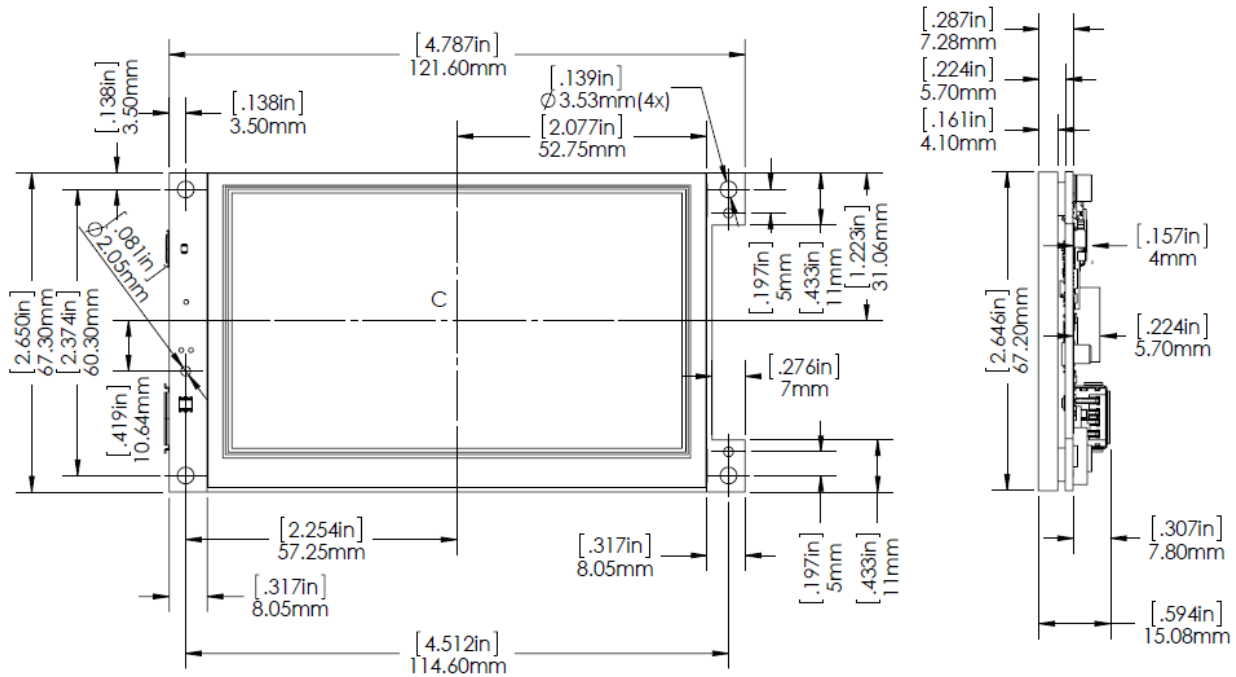

Dimensional drawings and complete 3D STEP models are available for most SIMs, including the SIM231. Visit www.seriousintegrated.com/docs for more information.

ALIGNMENT AND MOUNTING HOLES

There are four (4) 3.50mm holes by which the SIM should be attached into a chassis. Four M2.5, M3 or similar screws into correctly-sized standoffs from the inside of the bezel assembly will be more than adequate to firmly hold the module. The holes are over-sized from the typical screw in order to allow tolerance for standoff positioning as well as to ensure the module can be arranged to perfectly center in the bezel's opening.

Rather than attempt to tighten the screws while manually/visually positioning the module in the bezel opening, all SIMs include reference alignment holes to ensure perfect alignment within your bezel. Locate the several 2.05mm holes on the mechanical diagram – any two of these are meant to accommodate simple non-threaded alignment pins precisely positioned on the inside of your bezel. The SIM can be initially inserted onto the two precision alignment pins, thereby centering and positioning the active area of the LCD in your bezel, and then the four mounting screws can be inserted and tightened.

If your chassis is molded plastic, you can extrude very slightly tapered pins for this purpose. For metal bezels, off-the-shelf pins such as the [PEM Engineering MPP series](#) of self-clinching pins can be used. Depending on the tolerance of your insertion process of the pins into the metal bezel, you may want to undersize these pins to 1mm or 1.5mm, recognizing that the tolerance will slightly affect the consistency of the LCD positioning.

LCD DIMENSIONS AND BEZEL SIZE

The LCD glass positioning is a critical element for correct location of the display within a bezel. This positioning is well-defined in the Mechanical Design Package (MDP) for the specific variant, and should always be referenced relative to the center of the active pixel area of the display. Note in the diagram above the “C” designator which *does not* indicate the physical center of the LCD module or the SIM, but rather the center of the *active pixel area of the LCD display*. The MDP also shows a diagram similar to the following (from the SIM231-A01-R32ALM MDP):

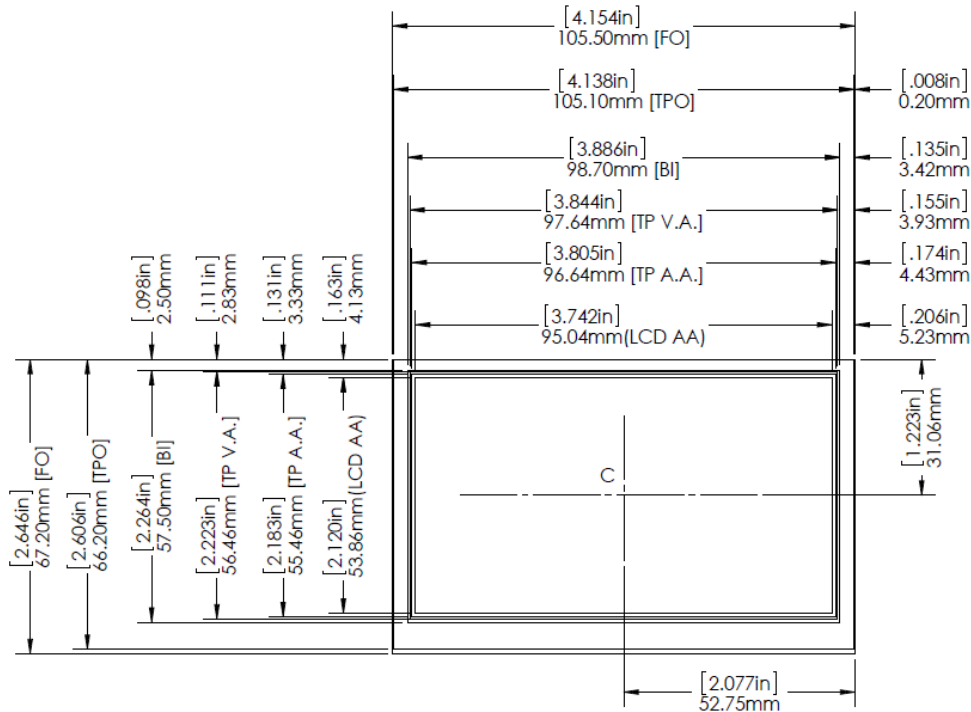

These two diagrams are critical for correct bezel design. The acronyms in the above LCD diagram are as follows:

- ▶ **FO: Frame Outer** -- outer dimensions of the physical LCD display module
- ▶ **TPO: Touch Panel Outer** -- outer limits of the resistive touch panel material
- ▶ **BI: Bezel Inner** -- inner limit where your bezel should be contacting the surface of the touch panel & LCD display with any gasket and not adversely affect touch performance
- ▶ **TP V.A.: Touch Panel Visual Area** -- conductors from the touch panel are no longer visible inside this area; your bezel will extend and cover to this dimension
- ▶ **TP A.A. Touch Panel Active Area** -- start of the active area of the touch panel, which may extend slightly outside the active area of the pixels
- ▶ **LCD AA: LCD Active Area** -- active pixel area of the LCD display; you will want to ensure visually the center (C) of this active area is centered in your bezel opening and that all the active area is visible to the end user

MODULE WEIGHT

The weight of the module is as follows, excluding any external cable harnesses, daughter cards, or batteries:

Variant	Permissible Range		
	Typ	Max	Units
A01	<i>tbd</i>	<i>tbd</i>	g
A02	<i>tbd</i>	<i>tbd</i>	g
A03	<i>tbd</i>	<i>tbd</i>	g
A04	<i>tbd</i>	<i>tbd</i>	g

DAUGHTER CARD PHYSICAL GUIDELINES



This section is provided as a helpful overview only.

The authoritative mechanical reference is the SIM535 Mechanical Design Package (MDP), which includes 2D drawings and STEP models, and is available for download at www.seriousintegrated.com/docs.

Most new SIMs across most of their variants include a [60-Pin Board-to-Board Expansion Connector](#). These variants also include six M3 threaded standoffs ([PennEngineering® SMTSO-M3-4-ET](#) or similar) to firmly support and attach a daughter card at the correct 4mm board-to-board distance.



Serious reserves the right to substitute components and/or change component layout on SIMs at any time without notice.

Exceeding the height envelope described below with the assumption of specific SIM component used and/or placement so as to utilize the inner-stack-height for daughter card components may cause mechanical conflicts in future SIM revisions.



It is possible to create a single daughter card that can dock into numerous SIMs, including the SIM115, SIM231, and SIM535.

Consult the respective Technical Reference Manuals (TRMs) to validate a compatible footprint: there are slight differences in the physical and electrical characteristic for daughter cards across different SIMs.

The board-to-board distance with this connector (when used with an identical mated connector) is only 4mm, enabling a daughter card to be developed with a very low overall combined profile. For components on the side of the daughter card facing the SIM, observe the maximum component height zones on the SIM – your components may extend only 4mm *less this distance* on the SIM-facing side of your PCB:



Example SIM231-A01-R32ALM Max Height Zone Map

For example, in the yellow shaded area above, the components on the SIM535 are less than 2mm total height, leaving (4mm board-to board) minus (2mm yellow height zone) = 2mm for components on the SIM-facing side of a daughter card.



Note that component data sheets typically indicate the physical height of the component which is not necessarily the same as the total height of the component after soldering, which may slightly raise (or even lower, in the case of some BGAs) the component.

For prototyping, any M3-0.5x6mm pan head or cap socket screw can be used to attach a daughter card to the SIM. For production units, the recommended screw and assembly torque specifications for attaching a daughter card are as follows:

Parameter	Recommendation		
Material	Stainless A1-50 or better		
Size	M3-0.5 x 6mm		
Head	Cap Socket (hex) or Pan Head 6-lobe/5-lobe/Torx®		
Patch	Nylon Patch per Specification IFI-524 2002 <i>Test Procedure for the Performance of Metric Nonmetallic Resistant Element Prevailing Torque Screws</i>		
	Specification	N·m	inch·lbs
	Maximum Prevailing Torque:	0.60	5.31
	Minimum First Removal Prevailing Torque	0.14	1.24
Insertion	*Recommended: 0.60 N·m (5.3 inch·lbs)		
Torque	*Maximum: 0.70 N·m (6.2 inch·lbs)		

**subject to final production characterization*

Small quantities of this type of screw can be readily purchased from [McMaster-Carr \(93705A813\)](#). Production volumes are readily available from many suppliers, including part number . 30C60MRPS/ NPAT from [North State Fastener, Inc.](#)



Do not apply excessive torque to daughter card screws into the threaded standoffs or they may tear from the PCB and permanently damage the SIM.



Do not use screws longer than recommended or the screw may apply force to the back side of the LCD panel and permanently damage it.

SERIOUS COMMUNICATIONS MODULES

Serious is in the process of releasing several new communications daughter cards designed to dock into the back of the SIM115, SIM231, and SIM535 as well as some future SIMs.

The [Serious Communications/Power Module 117 \(SCM117\)](#) family, for example, is a series of flexible and production-worthy communications and power conversion accessory boards for use with Serious Integrated Modules (SIMs). The SCM117 can dock directly into newer SIMs such as the [SIM115](#), [SIM231](#), and [SIM535](#) forming a low profile and cost effective combination.



SCM117 Docked into the SIM231

The SCM117 family has numerous members, or “variants”, implementing all or a subset of the following:

- ▶ RS232, RS422, RS485, and CAN transceivers
- ▶ Renesas RX111 MCU for local protocol translation and control
- ▶ DC-DC converter for powering the SCM and attached SIM from network-borne power

The SCM117’s most basic functionality is to provide network physical layer transceivers from the network cabling (RS232, RS485, RS422, or CAN) to the SIM, as well as network power conversion from whatever voltage (+9-25VDC) is available on the network cabling to the 5VDC required by the SIM and SCM.



Variants with the RX111 MCU place the RX111 in the middle of this conversation: the RX111 can communicate with the SIM using one protocol (for example, Modbus or the new *SHIP Bridge* protocol) and another protocol on the network (for example, your own proprietary protocol).

For more information on the SCM117, see the [Serious website](#).

HARDWARE OVERVIEW

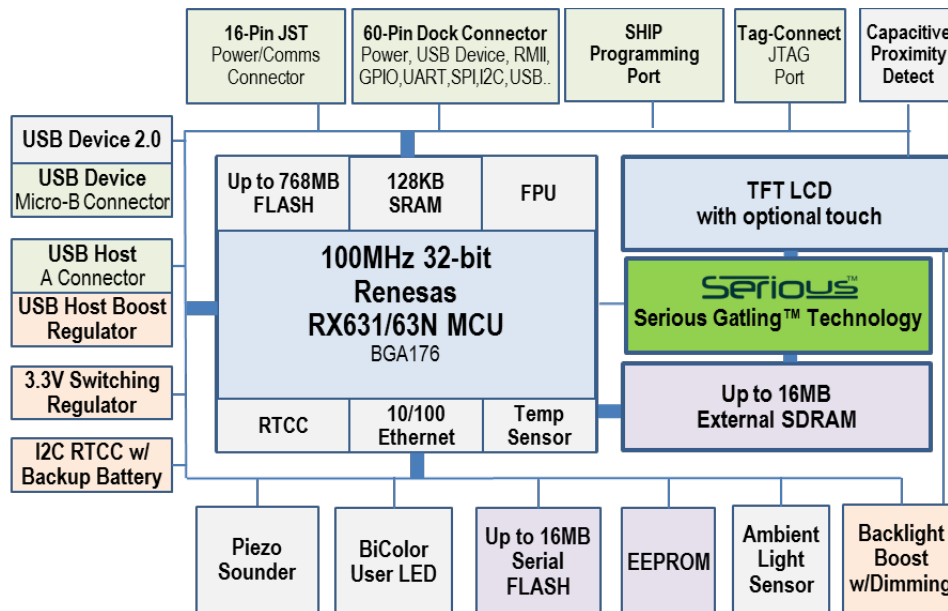

SIM231 Hardware Block Diagram
options depend on variant selected

Not all features are available on all SIM231 variants (family members).

HIGH PERFORMANCE RENESAS RX63N/631 MCU

The heart of the SIM231 is the 32-bit Renesas [RX63N/631](#) microcontroller (MCU) with 128kB of internal RAM, and zero wait-state internal execution FLASH. This powerful MCU is equipped with extensive analog and digital peripherals and, with software, can deliver an excellent user interface experience.

GRAPHIC COLOR LCD DISPLAY AND TOUCH OPTION

The SIM231's Liquid Crystal Display ("LCD" or "glass") has an on-glass row-column driver chip for illuminating pixels but has no on-glass frame buffer or memory. The pixel data must be delivered at approximately 60Hz per complete frame by the MCU, and stored and managed in system DRAM.

The [RX63N/631](#) MCU does not include an on-board graphics controller; however the raw horsepower of this MCU family, when combined with its peripherals and *Serious Gatling™ Technology* on the SIM231 can deliver impressive user interfaces, including multi-layer alpha blending, animation, and more.

With a 480x272 pixel resolution at 16 bits of color information per pixel (in RGB565 format), each frame requires 130,560 bytes of RAM. For a double-buffered system, 261,120 bytes for the two frame buffers are required. *Serious Gatling Technology* delivers excellent performance in this mode: less than 17% of the SDRAM bandwidth is required to deliver the frame buffer to the LCD at 60Hz.

For color-sensitive applications, such as those with extensive gradients, the SIM231 also supports 24 bit color mode. When 24-bit color mode is enabled, twice as much DRAM is required per frame buffer, and SDRAM bandwidth required to deliver the frame buffer to the LCD at 60Hz is less than 33%.

Some SIM231 variants include an integrated 4-wire resistive touch feature: a resistive film over the LCD returns an analog voltage in two dimensions which can be read by the touch controller and translated with a ratio into a pixel hit position. These touch-enabled variants also include a capacitive proximity detection feature where the proximity of a bare finger will be detectable by sensors which can be read by software.

SERIOUS GATLING™ TECHNOLOGY

Designed to assist the MCU's existing pixel to LCD connectivity, *Serious Gatling™ Technology* enables lower CPU overhead, increased throughput, and improved efficiency of rapid-fire pixel delivery from the CPU-Memory subsystem to the LCD display.

On the SIM231, the technology is implemented in an FPGA. The FPGA chip accommodates a fly-by-burst-mode DMA from the MCU into its internal pixel FIFO and delivers a fixed rate pixel stream to the LCD. It also manages all the timing to the LCD screen, delivering pixels at a rate determined by the FPGA configuration. This configuration (available from *Serious*) is downloaded at boot time through the RX MCU's SPI port.

The DMA unit on the RX MCU must be programmed to continuously deliver the current frame buffer as requested by the chip in a DREQ#/DACK# cycle using SDRAM continuous access single cycle mode.



The no-cost [Serious Human Interface™ Platform](#) software automatically initializes the FPGA and includes the correct driver for the SIM231's implementation of Serious Gatling Technology.

ON-MODULE PERIPHERALS

The SIM231 contains numerous on-module peripherals – many common to a vast and diverse set of OEM applications, including a Real Time Clock/Calendar (RTCC) (battery-backed on some modules), USB device, USB host, serial FLASH, high speed UART(s), EEPROM, bi-color indicator LED, and more.

ON-MODULE MEMORY

The SIM231 module has a variety of memory for storage of program, data, images, parameters, etc.:

FLASH Memory:

- › [Up to 16MB serial FLASH](#) memory attached via dedicated SPI (either 1 or 2 8MB chips)

EEPROM

- › Up to 4kbits [EEPROM](#)

RAM

- › 128kB RAM within the [RX63N/RX631](#) MCU
- › Up to 16MBytes of [SDRAM](#)

COMMUNICATIONS AND CONNECTORS

The SIM231 has numerous off-module communication ports and connectors. Some may or may not be available on specific SIM231 variants.

- ▶ [60-pin Board-to-Board Expansion Connector](#) with extensive I/O including:
 - ▶ DAC, SPI, I2C, CAN, and high-speed UART ports
 - ▶ USB device and host connections
 - ▶ Power input/output
 - ▶ GPIO
 - ▶ JTAG
 - ▶ RMII (on variants with RX63N)
- ▶ [Tag-Connect JTAG Port](#) for MCU-level programming/debugging
- ▶ [SHIP Programming Port](#) for easy reprogramming of your *Serious Human Interface™ Platform* (SHIP) GUI or SHIPEngine during development or in an high-throughput production environment
- ▶ [USB Micro B Device Connector](#)
 - ▶ USB 2.0 full speed device port
- ▶ [USB Host Port](#)
 - ▶ USB 2.0 full speed embedded host port capable of supplying up to 150mA
- ▶ [16-pin Power/Communications Connector](#)
 - ▶ Suitable for an inexpensive wire harness with latching plug connection
 - ▶ 3.3V Tx/Rx UART, SPI, I2C, +5V in, +3V3 out, RESET#, and DAC output

POWER

The SIM231 module can be powered from the +V_EXT signal (typically 5V) available on several connectors:

- ▶ [16-pin Power/Communications Connector](#)
- ▶ [60-pin Expansion Connector](#)
- ▶ [SHIP Programming Port](#)

The SIM231 can also be powered via the +5V_USBF signal on the USB device port. Commonly during GUI development with SHIPTide the USB Micro B connector can be connected to an adequately powered USB port.

Alternatively, and especially for those variants without the USB Micro B connector, the [SHIP Programming Port](#) can supply 5V from a suitable USB port on a powered hub, PC port, or USB AC Adapter when used with a [SHIP Programming Adapter 200 \(SPA200\)](#) and the [SHIP Programming Connector SPC200](#).



The permissible input voltage range, by variant, is detailed in the [DC Maximum Ratings](#) section.