



Chipsmall Limited consists of a professional team with an average of over 10 year of expertise in the distribution of electronic components. Based in Hongkong, we have already established firm and mutual-benefit business relationships with customers from,Europe,America and south Asia,supplying obsolete and hard-to-find components to meet their specific needs.

With the principle of “Quality Parts,Customers Priority,Honest Operation,and Considerate Service”,our business mainly focus on the distribution of electronic components. Line cards we deal with include Microchip,ALPS,ROHM,Xilinx,Pulse,ON,Everlight and Freescale. Main products comprise IC,Modules,Potentiometer,IC Socket,Relay,Connector.Our parts cover such applications as commercial,industrial, and automotives areas.

We are looking forward to setting up business relationship with you and hope to provide you with the best service and solution. Let us make a better world for our industry!



Contact us

Tel: +86-755-8981 8866 Fax: +86-755-8427 6832

Email & Skype: info@chipsmall.com Web: www.chipsmall.com

Address: A1208, Overseas Decoration Building, #122 Zhenhua RD., Futian, Shenzhen, China



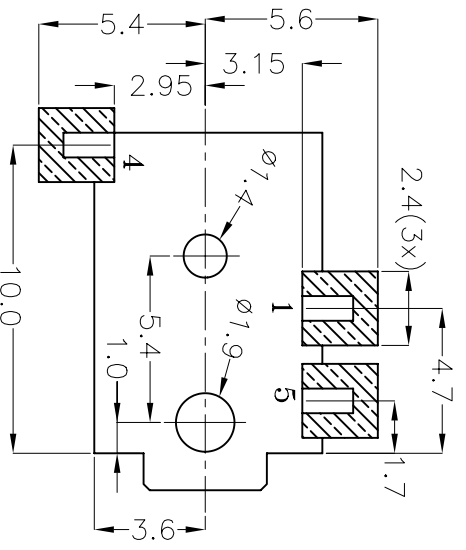
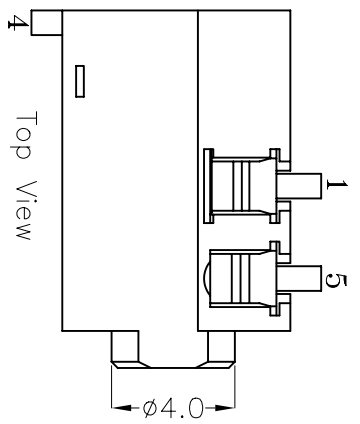

PCB Pad Layout
Top View

- Specifications:
1. Rated Voltage – 16 VDC
 2. Rated Current – 300 mA
 3. Contact Resistance – 100 mOHMS or less under all conditions, including After Life Testing.
 4. Insulation Resistance – 100 MOHMS or greater at 250 VDC.
 5. Dielectric Withstand Voltage – 250 VAC RMS for 1 minute.

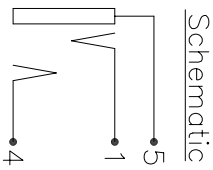

Schematic

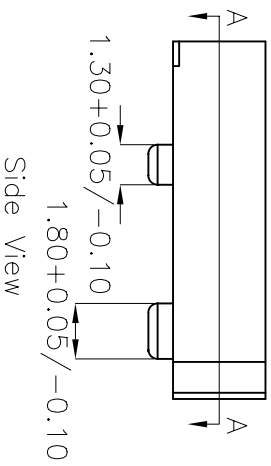

Side View

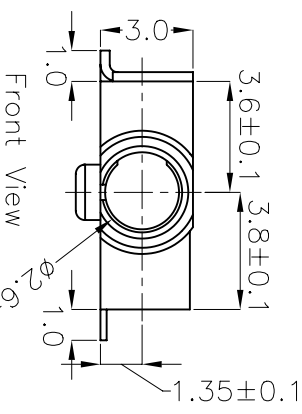

Front View

Section A-A

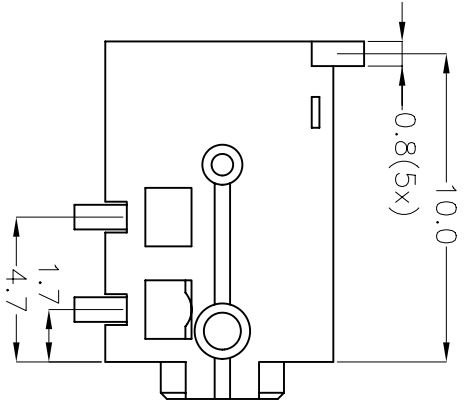

Bottom View

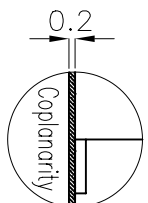
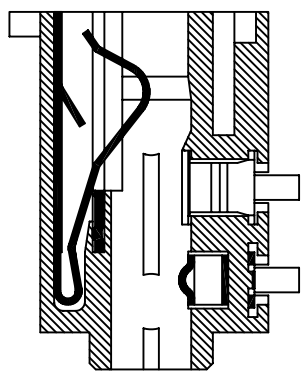

Mounting Surface

Term	Material	Color	Plating	Remark
Plastic Housing <P1>	Polyamide	Black		UL94V-0 Rated
Ring Contact <M1>	Ti-Cu Alloy		Gold Flash	20T
Tip Contact <M4>	Ti-Cu Alloy		Gold Flash	20T
Ground <M5>	Ti-Cu Alloy		Gold Flash	20T



9615 SW Allen, Suite 103
Beaverton, OR 97005
Phone: (503) 643-4899
800-275-4899
Fax: (503) 643-6129
Website: www.cuistack.com

2.50 Surface Mount Jack – Stereo