



Chipsmall Limited consists of a professional team with an average of over 10 year of expertise in the distribution of electronic components. Based in Hongkong, we have already established firm and mutual-benefit business relationships with customers from,Europe,America and south Asia,supplying obsolete and hard-to-find components to meet their specific needs.

With the principle of “Quality Parts,Customers Priority,Honest Operation,and Considerate Service”,our business mainly focus on the distribution of electronic components. Line cards we deal with include Microchip,ALPS,ROHM,Xilinx,Pulse,ON,Everlight and Freescale. Main products comprise IC,Modules,Potentiometer,IC Socket,Relay,Connector.Our parts cover such applications as commercial,industrial, and automotives areas.

We are looking forward to setting up business relationship with you and hope to provide you with the best service and solution. Let us make a better world for our industry!



Contact us

Tel: +86-755-8981 8866 Fax: +86-755-8427 6832

Email & Skype: info@chipsmall.com Web: www.chipsmall.com

Address: A1208, Overseas Decoration Building, #122 Zhenhua RD., Futian, Shenzhen, China



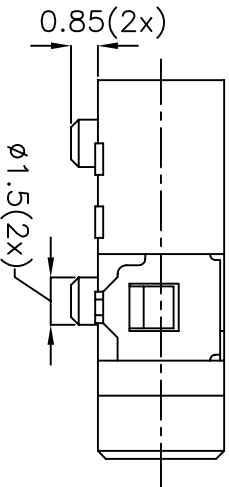
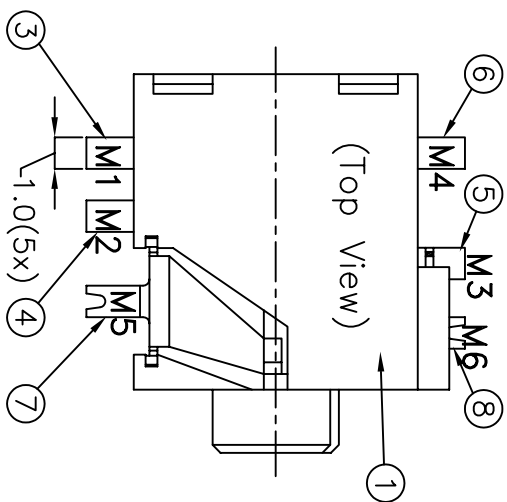

Specifications
 Rated Voltage: 16VDC
 Rated Current: 300mA
 Contact Resistance: 100 mOHMS or less under all conditions including after life testing.
 Insulation Resistance: 100 M OHMS or greater at 500VDC
 Voltage: 250V AC RMS for 1 Minute
 Life: 5,000 cycles min.

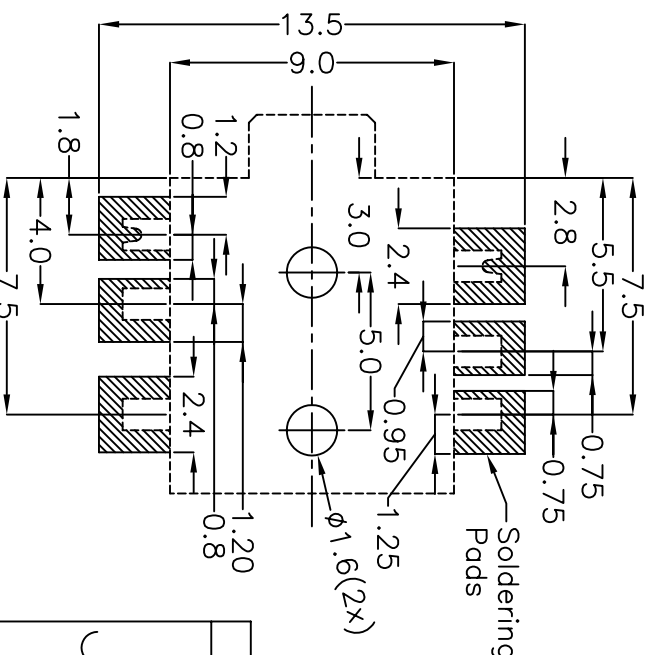
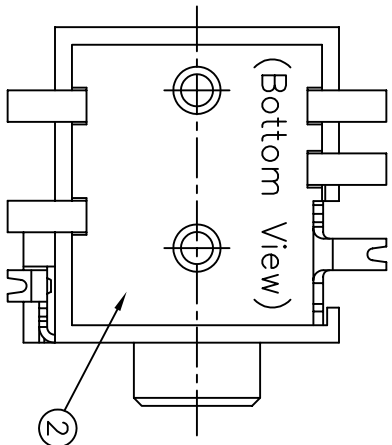
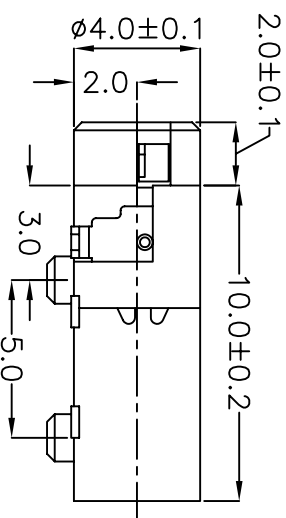
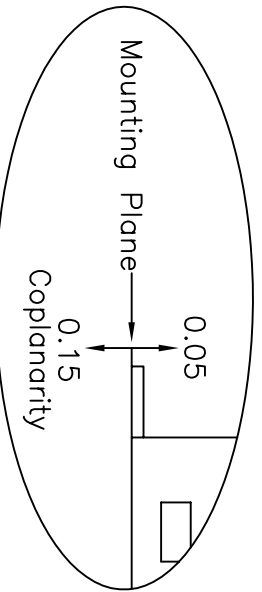
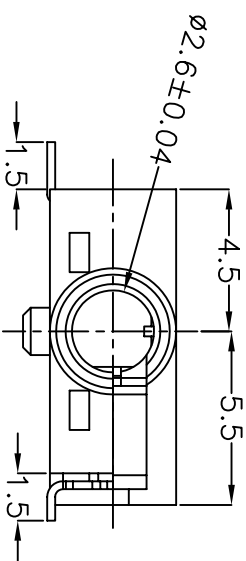

Pad Layout
Top View

8	Ground <M6>	PBS		Gold Flash 30T
7	Signal <M5>	PBS		Gold Flash 30T
6	Tip Contact <M4>	Ti-Cu Alloy		Gold Flash 20T
5	Shunt (Tip) <M3>	Brass		Gold Flash 30T
4	Shunt (Ring) <M2>	Brass		Gold Flash 30T
3	Ring Contact <M1>	Ti-Cu Alloy		Gold Flash 20T
2	Cover	PY6T	Black	UL94V-0 Rated
1	Plastic Housing <P1>	Polyamide	Black	UL94V-0 Rated
l/m	Term	Material	Color	Plating Remark

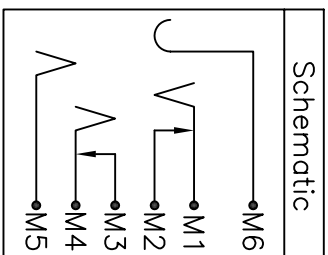

9615 SW Allen, Suite 103
 Beaverton, OR 97005
 Phone: (503) 643-4899
 (800)-275-4899
 Fax: (503) 372-1266
 Website: www.cui.com

TITLE: SMT Audio Jack w/4 Conductors 2.5mm

PART NO. SJ-42516-SMT UNITS: Millimeters
 DRAWN BY: Todd R. White APPROVED BY: SCALE: 4x