



Chipsmall Limited consists of a professional team with an average of over 10 year of expertise in the distribution of electronic components. Based in Hongkong, we have already established firm and mutual-benefit business relationships with customers from,Europe,America and south Asia,supplying obsolete and hard-to-find components to meet their specific needs.

With the principle of “Quality Parts,Customers Priority,Honest Operation,and Considerate Service”,our business mainly focus on the distribution of electronic components. Line cards we deal with include Microchip,ALPS,ROHM,Xilinx,Pulse,ON,Everlight and Freescale. Main products comprise IC,Modules,Potentiometer,IC Socket,Relay,Connector.Our parts cover such applications as commercial,industrial, and automotives areas.

We are looking forward to setting up business relationship with you and hope to provide you with the best service and solution. Let us make a better world for our industry!



Contact us

Tel: +86-755-8981 8866 Fax: +86-755-8427 6832

Email & Skype: info@chipsmall.com Web: www.chipsmall.com

Address: A1208, Overseas Decoration Building, #122 Zhenhua RD., Futian, Shenzhen, China



REV.	DESCRIPTION	DATE
A	NEW DRAWING	1/3/2006
B	updated PCB layout	2/6/2008
C	added TR package option	11/29/2012

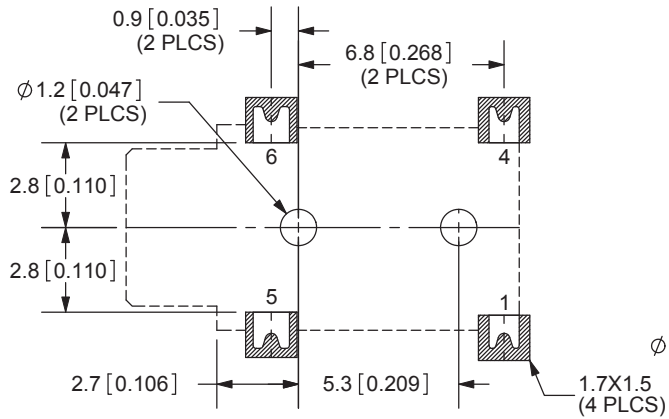
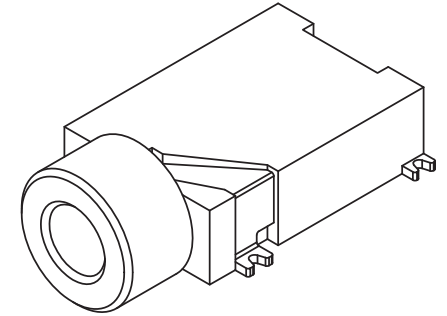
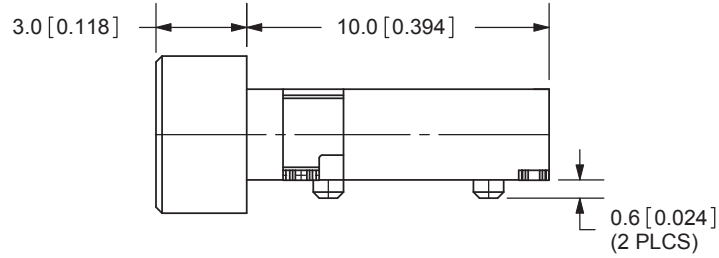
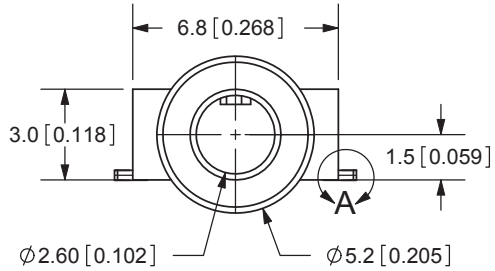
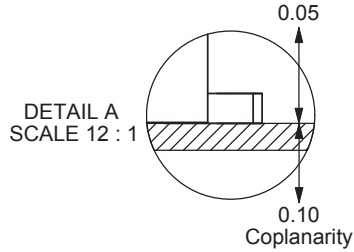

PCB LAYOUT
TOP VIEW

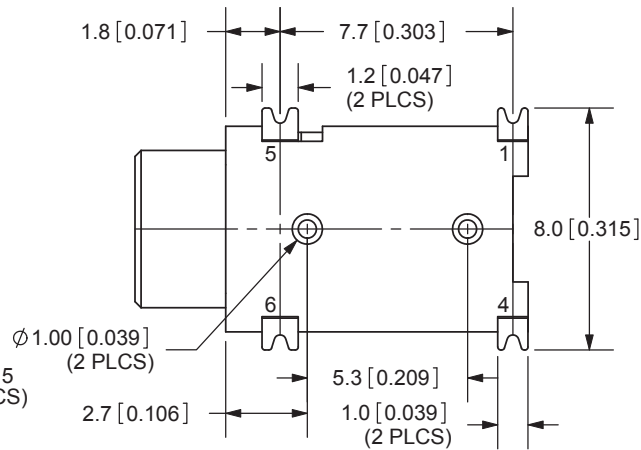

Note:
Add suffix "-TR" to the model number for
tape & reel packaging

TOLERANCE:
X.X ± 0.3 mm
X.XX ± 0.2 mm

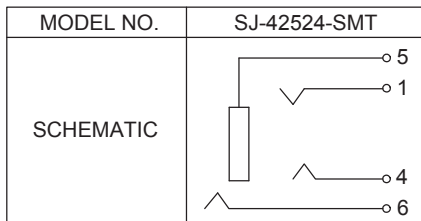

SPECIFICATIONS:
 RATING: 16V DC @ 300mA
 CONTACT RESISTANCE: 100m OHMS MAX
 INSULATION RESISTANCE: 100M OHMS MIN: 500V DC
 VOLTAGE WITHSTAND: 500V AC R.M.S. FOR 1 MINUTE
 LIFE: 5,000 CYCLES
 OPERATING TEMP: -40 ~ +85C

	MATERIAL	PLATING
TERMINAL 1	Titanium Copper	Silver
TERMINAL 4	Titanium Copper	Silver
TERMINAL 5	Phosphor Bronze	Silver
TERMINAL 6	Brass	Gold
HOUSING	PBT	



20050 SW 112th Ave.
 Tualatin, OR 97062
 Phone: 503-612-2300
 800-275-4899
 Fax: 503-612-2383
 Website: www.cui.com

TITLE:	SMT AUDIO JACK W/4 CONDUCTORS 2.5mm	REV:	C
PART NO.	SJ-42524-SMT	UNITS:	MM [INCHES]
DRAWN BY:	ZRJ	APPROVED BY:	
		SCALE:	4:1

PC FILE NAME:
SJ-42524-SMT

COPYRIGHT 2012 BY CUI INC.

REV.	DESCRIPTION
A	NEW DRAWING
B	updated PCB
C	added TR package

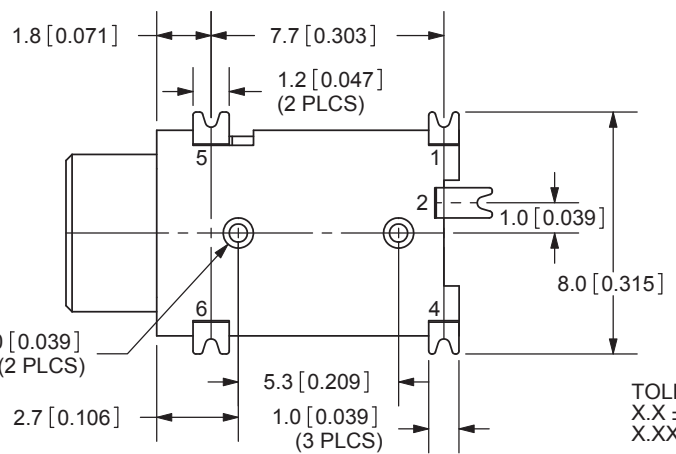
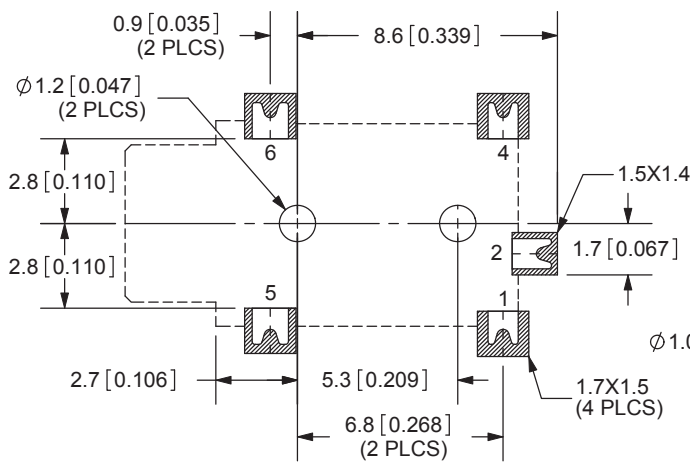
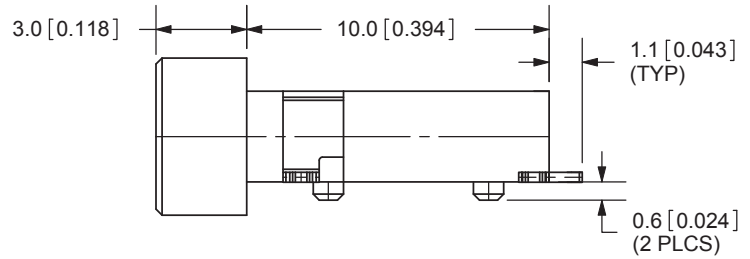
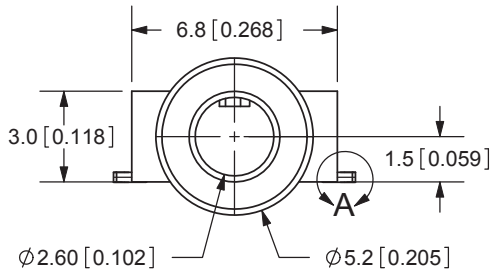
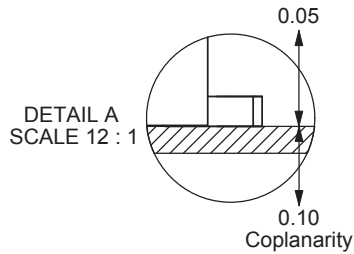

PCB LAYOUT
TOP VIEW

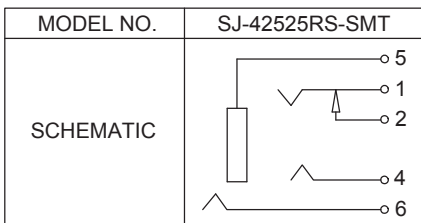

SPECIFICATIONS:
 RATING: 16V DC @ 300mA
 CONTACT RESISTANCE: 100m OHMS MAX
 INSULATION RESISTANCE: 100M OHMS MIN: 500V DC
 VOLTAGE WITHSTAND: 500V AC R.M.S. FOR 1 MINUTE
 LIFE: 5,000 CYCLES
 OPERATING TEMP: -40 ~ +85C

	MATERIAL	PLATING
TERMINAL 1	Titanium Copper	Silver
TERMINAL 2	Brass	Silver
TERMINAL 4	Titanium Copper	Silver
TERMINAL 5	Phosphor Bronze	Silver
TERMINAL 6	Brass	Gold
HOUSING	PBT	

TITLE: SMT AUDIO J

PART NO. SJ-42525RS

DRAWN BY: ZRJ

PC FILE NAME:
SJ-42525RS-SMT

COPYRIGHT 2012 BY CUI INC.

Note:
Add suf
taps & r

For more information, please visit the
next page.

REV.	DESCRIPTION
A	NEW DRAWING
B	updated PCB
C	housing material
D	added TR package

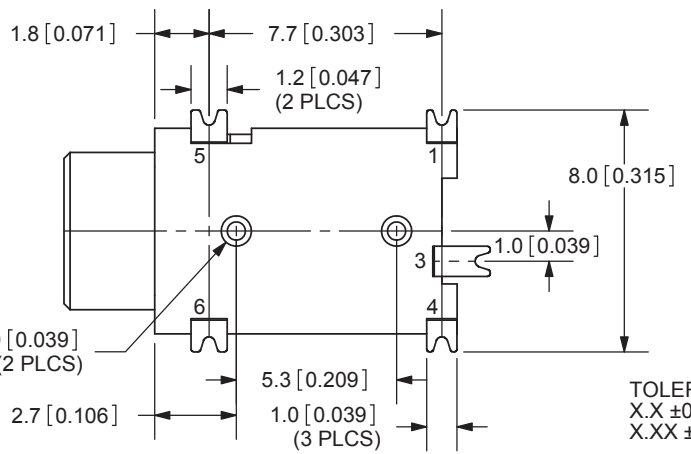
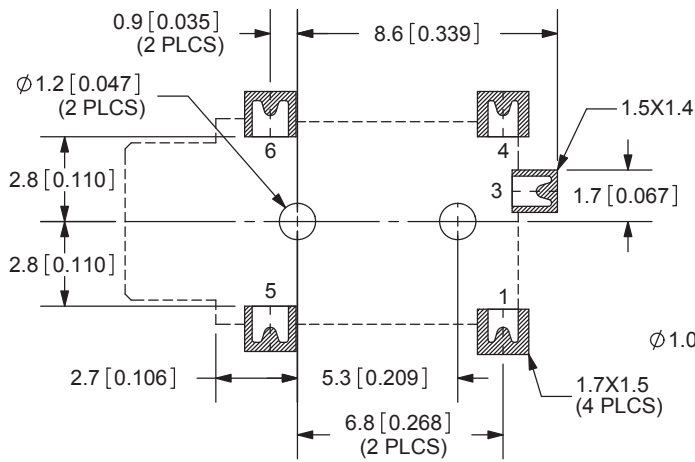
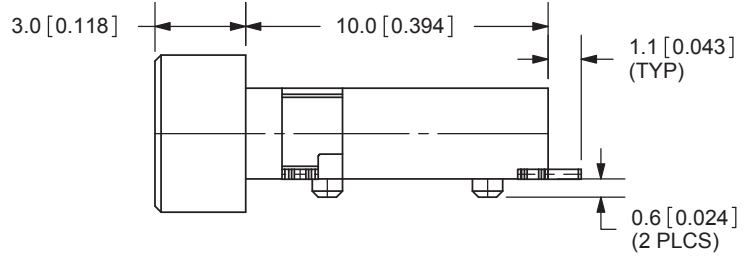
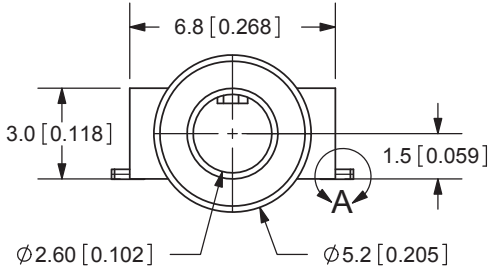
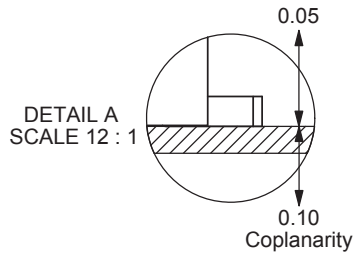

PCB LAYOUT
TOP VIEW

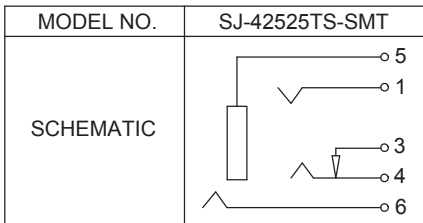

SPECIFICATIONS:
 RATING: 16V DC @ 300mA
 CONTACT RESISTANCE: 100m OHMS MAX
 INSULATION RESISTANCE: 100M OHMS MIN: 500V DC
 VOLTAGE WITHSTAND: 500V AC R.M.S. FOR 1 MINUTE
 LIFE: 5,000 CYCLES

	MATERIAL	PLATING
TERMINAL 1	Titanium Copper	Silver
TERMINAL 3	Brass	Silver
TERMINAL 4	Titanium Copper	Silver
TERMINAL 5	Phosphor Bronze	Silver
TERMINAL 6	Brass	Gold
HOUSING	LCP	

TOLERANCE:
 X.X ±0.3mm
 X.XX ±0.2mm

For more information, please visit the [product page](#).

TITLE: SMT AUDIO J...
 PART NO. SJ-42525T...
 DRAWN BY: ZRJ

PC FILE NAME:
 SJ-42525TS-SMT

COPYRIGHT 2012 BY CUI INC.

REV.	DESCRIPTION
A	NEW DRAWING
B	updated PCB
C	housing material
D	added TR package

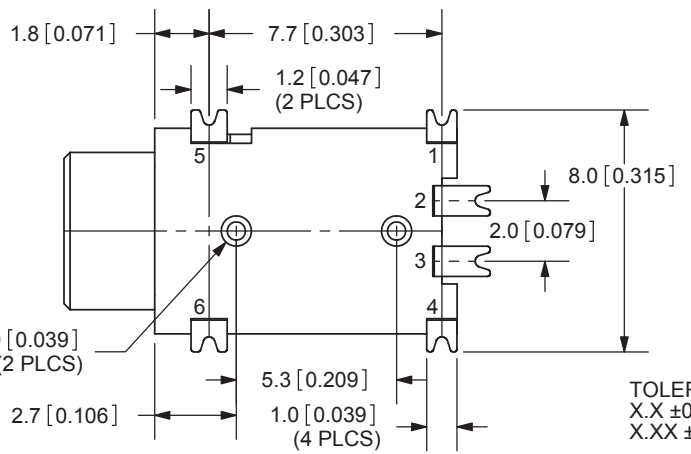
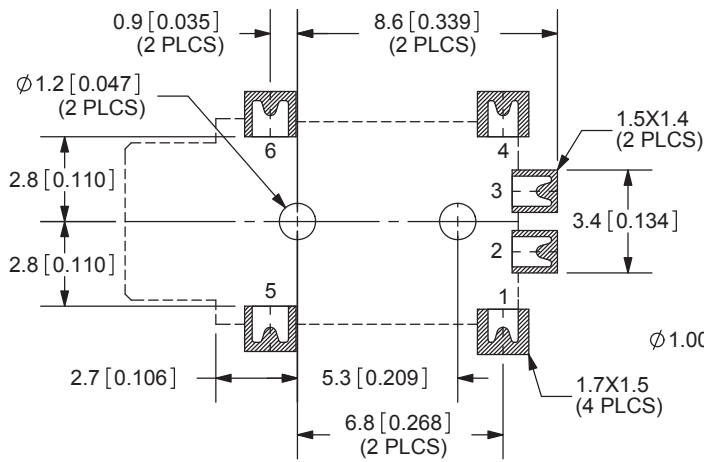
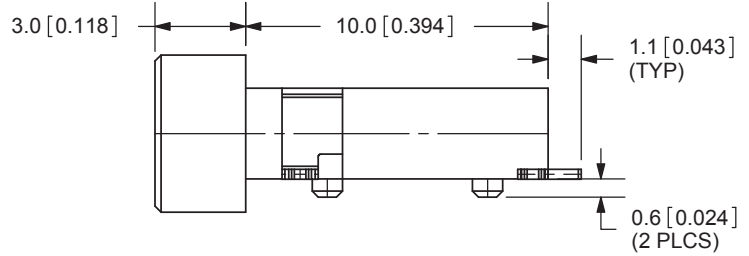
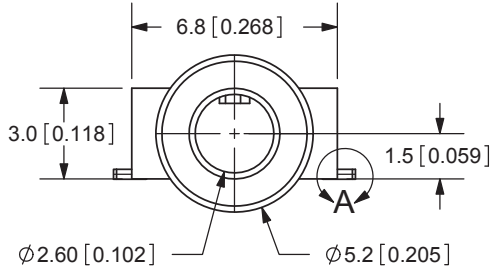
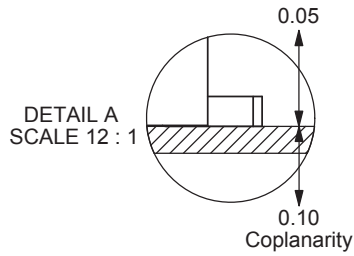

PCB LAYOUT
TOP VIEW

SPECIFICATIONS:
 RATING: 16V DC @ 300mA
 CONTACT RESISTANCE: 100m OHMS MAX
 INSULATION RESISTANCE: 100M OHMS MIN: 500V DC
 VOLTAGE WITHSTAND: 500V AC R.M.S. FOR 1 MINUTE
 LIFE: 5,000 CYCLES

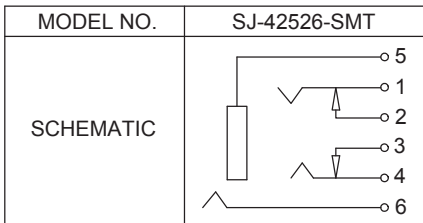

	MATERIAL	PLATING
TERMINAL 1	Titanium Copper	Silver
TERMINAL 2	Brass	Silver
TERMINAL 3	Brass	Silver
TERMINAL 4	Titanium Copper	Silver
TERMINAL 5	Phosphor Bronze	Silver
TERMINAL 6	Brass	Gold
HOUSING	LCP	

TITLE: SMT AUDIO J...
 PART NO. SJ-42526-S...
 DRAWN BY: ZRJ

PC FILE NAME:
SJ-42526-SMT

COPYRIGHT 2012 BY CUI INC.

For more information, please visit the product page.

