



Chipsmall Limited consists of a professional team with an average of over 10 year of expertise in the distribution of electronic components. Based in Hongkong, we have already established firm and mutual-benefit business relationships with customers from,Europe,America and south Asia,supplying obsolete and hard-to-find components to meet their specific needs.

With the principle of "Quality Parts,Customers Priority,Honest Operation,and Considerate Service",our business mainly focus on the distribution of electronic components. Line cards we deal with include Microchip,ALPS,ROHM,Xilinx,Pulse,ON,Everlight and Freescale. Main products comprise IC,Modules,Potentiometer,IC Socket,Relay,Connector.Our parts cover such applications as commercial,industrial, and automotives areas.

We are looking forward to setting up business relationship with you and hope to provide you with the best service and solution. Let us make a better world for our industry!



Contact us

Tel: +86-755-8981 8866 Fax: +86-755-8427 6832

Email & Skype: info@chipsmall.com Web: www.chipsmall.com

Address: A1208, Overseas Decoration Building, #122 Zhenhua RD., Futian, Shenzhen, China





Dual-Output, Switch-Mode Regulator (+5V to ±15V or ±12V)

MAX743

General Description

The MAX743 DC-DC converter IC contains all the active circuitry needed to build small, dual-output power supplies. Relying on simple two-terminal inductors rather than transformers, the MAX743 regulates both outputs independently to within ±4% over all conditions of line voltage, temperature, and load current.

The MAX743 typically provides 75% to 82% efficiency over most of the load range. It operates with current-mode feedback at 200kHz, so it can be used with small, lightweight external components. Also, ripple and noise are easy to filter.

The MAX743 is inherently reliable due to its internal power transistors and monolithic construction. Thermal shut-down prevents overheating, and cycle-by-cycle current sensing protects the power-switch transistors. Other features include undervoltage lock-out and programmable soft-start.

Inductors, capacitors, and diodes to complement the MAX743 can be ordered directly from Maxim in production quantities (page 11). An evaluation kit for prototyping (MAX743EVKIT) is also available (page 9).

If higher load currents are needed, refer to the MAX742 data sheet for a device that drives external power MOSFETs.

Applications

- DC-DC Converter Module Replacement
- Distributed Power Systems
- Computer Peripherals
- Portable Instruments

Pin Configuration

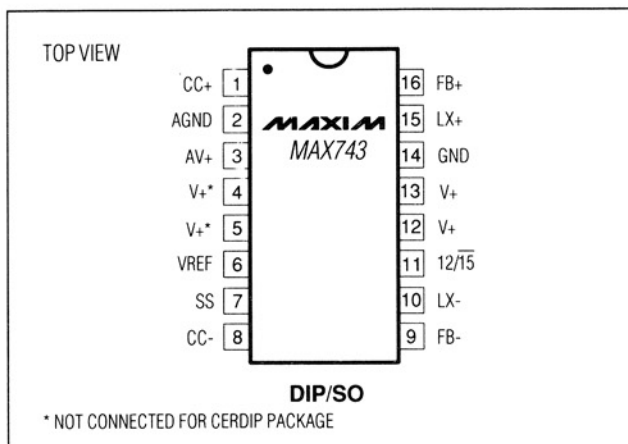

Features

- ◆ Generates ±100mA or ±125mA
- ◆ Specs Guaranteed for In-Circuit Performance
- ◆ ±4% Output Tolerance Max Over Temp, Line, and Load
- ◆ 82% Typ Efficiency
- ◆ Low-Noise, Current-Mode Feedback
- ◆ On-Board Current Limiting
- ◆ Thermal Shutdown Protection
- ◆ Undervoltage Lock-Out and Soft-Start
- ◆ Switches From ±15V to ±12V Under Logic Control
- ◆ Evaluation Kit Available
- ◆ Internal Power MOSFETs

Ordering Information

PART	TEMP. RANGE	PIN-PACKAGE
MAX743CPE	0°C to +70°C	16 Plastic DIP
MAX743CWE	0°C to +70°C	16 Wide SO
MAX743C/D	0°C to +70°C	Dice
MAX 743EPE	-40°C to +85°C	16 Plastic DIP
MAX743EWE	-40°C to +85°C	16 Wide SO
MAX743MJE	-55°C to +125°C	16 CERDIP

Ordering information continued on page 11.

Typical Operating Circuit

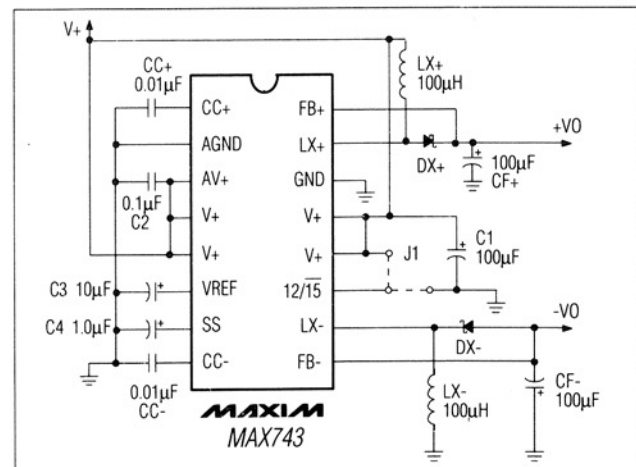

Dual-Output, Switch-Mode Regulator (+5V to $\pm 15V$ or $\pm 12V$)

ELECTRICAL CHARACTERISTICS

(Circuit of Figure 1, $+4.5V < V_+ < +5.5V$, Note 1.)

PARAMETER	CONDITIONS		MIN	TYP	MAX	UNITS
Output Voltage						
$\pm 15V$ Mode	$0mA < I_{LOAD} < 100mA$ $12/15 = 0V$	$T_A = +25^\circ C$	14.55		15.45	V
		$T_A = T_{MIN}$ to T_{MAX}	14.40		15.60	
$\pm 12V$ Mode	$0mA < I_{LOAD} < 125mA$ $12/15 = V_+$	$T_A = +25^\circ C$	11.64		12.36	V
		$T_A = T_{MIN}$ to T_{MAX}	11.52		12.48	

ELECTRICAL CHARACTERISTICS

(Circuit of Figure 1, $V_+ = +5.0V$, $12/15$ pin = $0V$, $I_{LOAD} = 0$, $T_A = T_{MIN}$ to T_{MAX} , unless otherwise noted.)

PARAMETER	CONDITIONS		MIN	TYP	MAX	UNITS
Efficiency	$I_{LOAD} = \pm 50mA$	LX = MAXL001		79		%
		LX = MPP Toroid		82		
Supply Current (Note 2)				20	30	mA
Standby Current	$V_{REF} = +5V$, includes V_{REF} current			2.2	4	mA
Line Regulation	$V_+ = +4.5V$ to $+5.5V$				0.05	%/%
Load Regulation	$I_{LOAD} = 0$ to $100mA$				1	%
Reference Voltage	V_{REF}			2.0		V
Oscillator Frequency			170	200	230	kHz
Undervoltage Lock-Out	Measured at V_+		3.8		4.2	V
Thermal Shutdown Threshold				+190		$^\circ C$
LX+ On Resistance (Note 3)				1.2	3.0	Ω
LX- On Resistance (Note 3)				1.0	2.2	Ω
LX+ Leakage Current (Note 4)	$LX_+ = +17V$, $V_+ = 6V$				100	μA
LX- Leakage Current (Note 4)	$LX_- = -17V$, $V_+ = 6V$				-100	μA
Compensation Pin Impedance	CC+, CC-			10		k Ω
Soft-Start Source Current	SS = $0V$		3.0		7.0	μA
Soft-Start Sink Current	SS = $2V$, $V_+ = 3.8V$		0.5	2.0		mA

Note 1: All devices tested to full-load conditions with 50ms pulsed loads using automatic test equipment. In continuous operation, the maximum allowable output current is determined by package thermal characteristics and passive component ratings.

Note 2: Total supply current including inductor current. The worst case for supply current occurs at low input voltage.

Note 3: Guaranteed by design, not 100% tested. Output currents are 100% tested.

Note 4: Tested at wafer level only, not in packaged form.

Dual-Output, Switch-Mode Regulator (+5V to ±15V or ±12V)

MAX743

ABSOLUTE MAXIMUM RATINGS

Supply Voltage (V+ or AV+ to GND)	+7V, -0.3V (±12V Mode) +6V, -0.3V (±15V Mode)
Output Switch Voltages (LX+ to GND) (LX- to V+)	+17V, -0.3V -23V, +0.3V
Output Switch Currents (LX+ Sink Current, Peak) (LX- Source Current, Peak)	2.0A -2.0A
Power Dissipation	See Figure 2

Operating Temperature Range	
MAX743C	-40°C to +70°C
MAX743E	-40°C to +85°C
MAX743MJE	-55°C to +125°C
Junction Temperature	
MAX743C/E	+150°C
MAX743MJE	+175°C
Storage Temperature Range	-65°C to +160°C
Lead Temperature (Soldering, 10 sec.)	+300°C

Stresses beyond those listed under "Absolute Maximum Ratings" may cause permanent damage to the device. These are stress ratings only, and functional operation of the device at these or any other conditions beyond those indicated in the operational sections of the specifications is not implied. Exposure to absolute maximum rating conditions for extended periods may affect device reliability.

CAUTION - OBSERVE PROTOTYPING PRECAUTIONS BELOW

- DO NOT INSERT DEVICE INTO SOCKET WITH POWER APPLIED.
- BE CERTAIN THAT OUTPUT FILTER CAPACITORS ARE CONNECTED.
- DO NOT SOLDER OR WORK ON CIRCUIT WHILE POWER IS APPLIED.
- OBSERVE SUPPLY VOLTAGE RATINGS CAREFULLY.

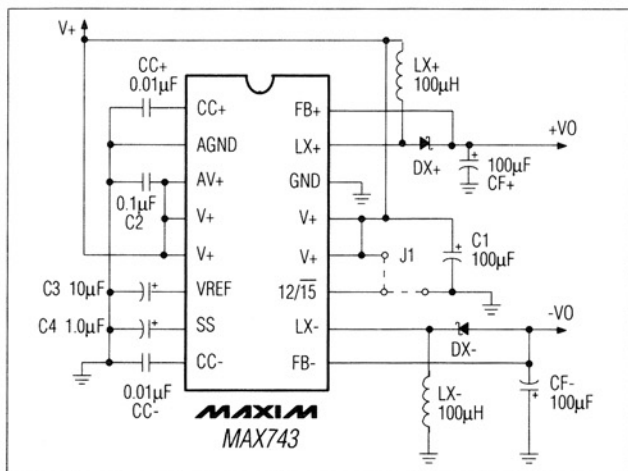

Figure 1. Basic Application Circuit

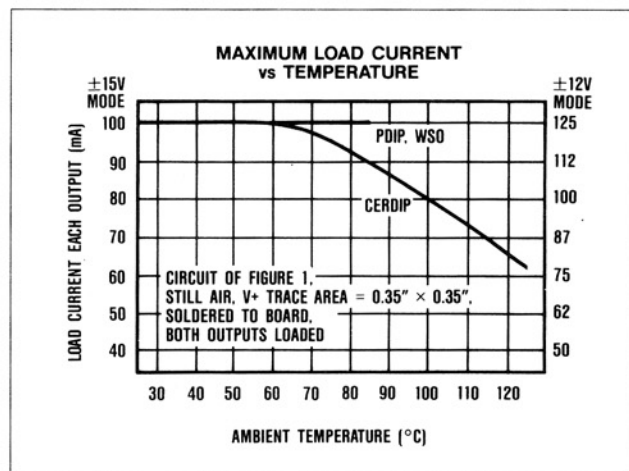
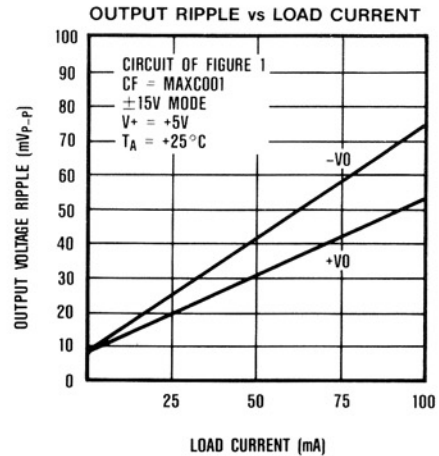
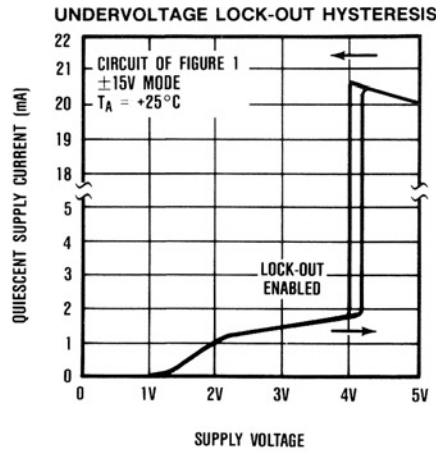
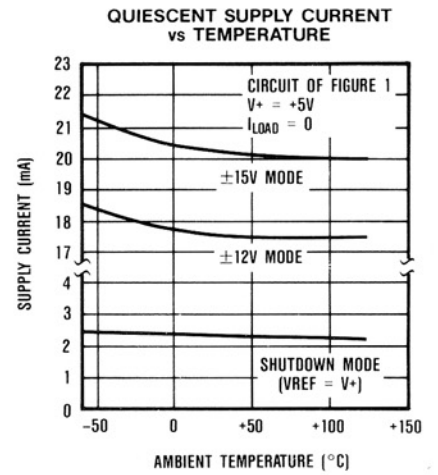
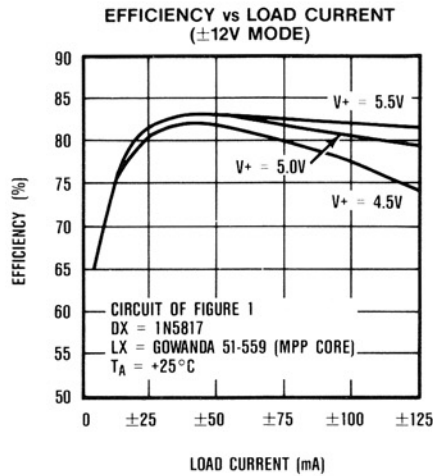
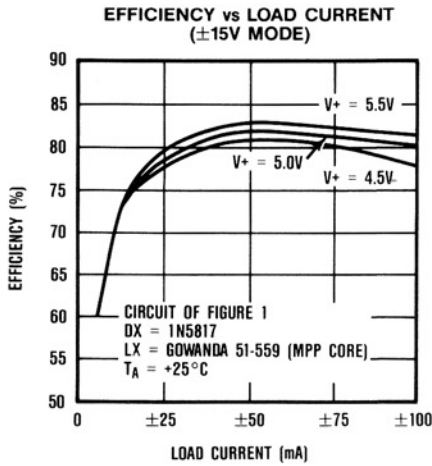

Figure 2. Maximum Load Current Vs. Temperature

- Notes:**
- LX Inductors: MAXL001 or equivalent.
 - CF Filter Capacitors: MAXC001 or 100µF low-ESR equivalent.
 - C1 Bypass Capacitor: MAXC001 or 22µF 16V Tantalum or equivalent.
 - C4 Soft-Start Capacitor is optional.
 - DX Schottky Diodes: 1N5817 or equivalent.

Dual-Output, Switch-Mode Regulator (+5V to ±15V or ±12V)

Typical Operating Characteristics



Dual-Output, Switch-Mode Regulator (+5V to $\pm 15V$ or $\pm 12V$)

Pin Description

PIN	NAME	FUNCTION
1	CC+	Step-Up Compensation Capacitor
2	AGND	Analog Ground
3	AV+	Analog Supply Voltage Input (+5V)
4, 5	V+	High-Current Supply Voltage Input (+5V); N.C. for CERDIP Package
6	VREF	Reference Voltage Output (+2.00V)
7	SS	Soft-Start Timing Capacitor (Sources 5 μ A)
8	CC-	Inverting Compensation Capacitor
9	FB-	Inverting-Section Feedback Input
10	LX-	Inverting-Section Switch Output
11	12/15	Selects VOUT: Ground for $\pm 15V$ or tie to V+ for $\pm 12V$
12, 13	V+	High-Current Supply Voltage Input (+5V)
14	GND	High-Current Ground
15	LX+	Step-Up Section Switch Output
16	FB+	Step-Up Section Feedback Input

Operating Principle

Each current-mode controller consists of a summing amplifier that adds three signals: the current waveform from the power switch FET, a VOUT-VREF error signal, and a ramp signal for AC compensation generated by the oscillator (Figure 3). The output of the summing amplifier gates a flip-flop, which in turn drives the power FET switch.

Both switches are synchronized to the oscillator and turn on simultaneously when the flip-flops are set. The transistors turn off individually when their switch currents reach a trip threshold determined by the VOUT-VREF error signal. This creates a duty-cycle modulated pulse train at 200kHz, where the on time is proportional to both the output voltage error signal and the peak inductor current. Low peak currents or high output voltage error signals result in a high duty cycle (up to 90% maximum).

The MAX743 oscillator frequency is generated without external components and is not adjustable. The device is laser-trimmed to 200kHz at wafer level, resulting in clean, predictable operation.

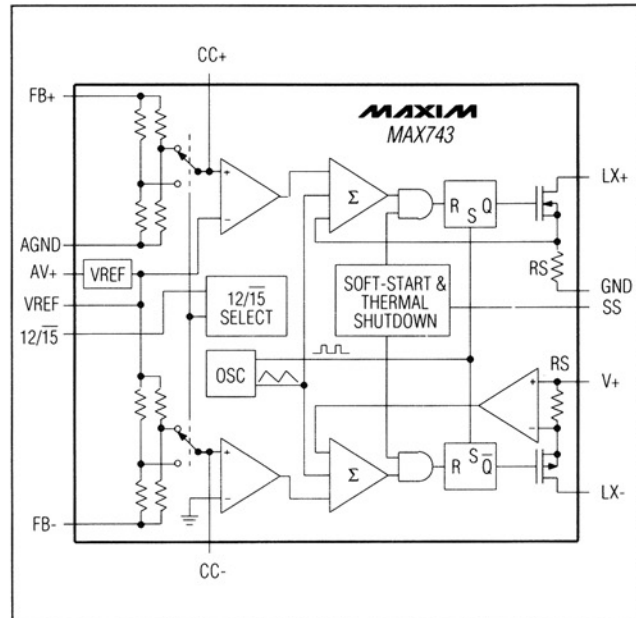

Figure 3. MAX743 Block Diagram

In-Circuit Testing for Guaranteed Performance

The circuit in Figure 1 has been tested at all line, load, output current, and temperature limits. Refer to the Electrical Characteristics table for guaranteed in-circuit specifications. Successful use of this circuit requires no component calculations.

Many modifications of this basic circuit, such as remote shutdown, reduced noise, nonstandard passive components, and oddball input/output voltages, are explored in an application note. Refer to UM-3, MAX742/MAX743 Application Notes.

Standard 3W Application

With MAXL001 inductors and MAXC001 or equivalent output filter capacitors, output voltage ripple at full load is about 75mVp-p at the oscillator frequency (200kHz). In addition, about 250mV transient noise occurs at the LX switch transitions. Extra filtering (Figure 9) reduces both noise components.

The choice of inductor type involves a trade off, which optimizes either cost and size or EMI and noise performance. Suggested design approaches for mainstream applications are given in the Component Design Chart of Table 1.

Dual-Output, Switch-Mode Regulator (+5V to ±15V or ±12V)

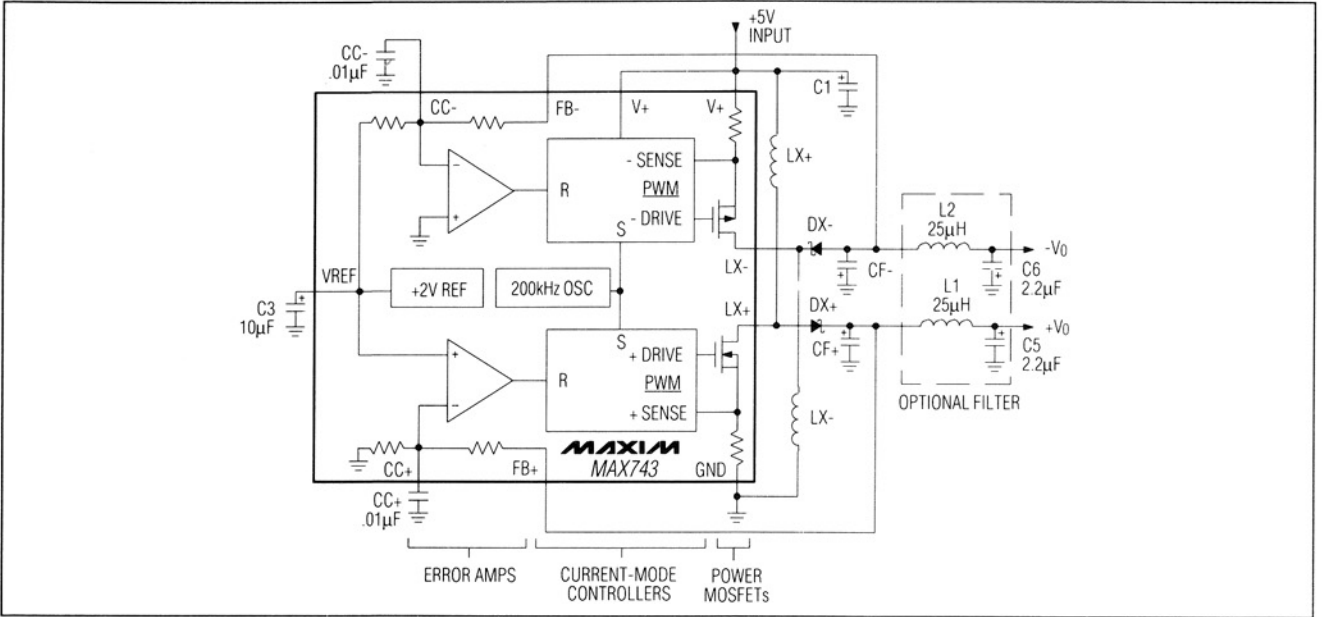

Figure 4. Functional Diagram with Optional Pi Filter

Table 1. Component Design Chart

DESIGN REQUIREMENT				
LOW COST, LOW NOISE	LOWEST COST	WIDE TEMP RANGE	MINIATURE	SURFACE MOUNT
INDUCTOR				
Iron-Powder Toroid	Ferrite Bobbin	Many Types OK	Hi-Flux (MPP) Toroid	Hi-Flux (MPP) Toroid
* 0.6" Diameter * Low EMI * 79% Efficiency	* 0.6" Long * Some Noise * 82% Efficiency		* 0.28" Diameter * Low EMI * 80% Efficiency	* Surface Mount Version
MAXL001 Sold by Maxim G # 51-548	C # 7070-25 G # GA10-103K I # LS4-100	All Listed Inductors	Gowanda Corp. Part # 51-559	Gowanda Corp. Part # 51-560
CAPACITOR				
150µF Low-ESR Aluminum Electrolytic	220µF Standard Aluminum Electrolytic	Solid Tantalum (Sintered Anode)	47µF Tantalum// 4.7µF Ceramic	33µF Tantalum// 33µF Tantalum
* -25°C to +105°C * Lowers Ripple * Radial Mount	* 0°C to +85°C * 16V or up	* -55°C to +125°C * Lowers Ripple	* 0°C to +70°C * May Need Additional Compensation	* 0°C to +70°C
MAXC001 Sold by Maxim Nichicon PL Series	Multiple Suppliers	THF Series Mallory	RPE230 Series Murata Erie	267 Series Matsuo
RECTIFIER				
1N5817	1N5817	1N5802 (UES1102)	MBR030 Motorola	PRL5817 Amperex/Phillips
PRINTED CIRCUIT LAYOUT				
See Figure 6	See UM-3 MAX742/743 Application Notes	Modify Layout of Figure 6	Modify Layout of Figure 6	See UM-3 MAX742/743 Application Notes

C = Caddell-Burns (516) 746-2310

G = Gowanda (716) 532-2234

I = Inductor Supply (714) 978-2277

Dual-Output, Switch-Mode Regulator (+5V to $\pm 15V$ or $\pm 12V$)

MAX743

Printed Circuit Layout for Radial-Mount Components

Clean, stable operation requires a good layout (Figure 6). Grounding is especially important for low-noise operation. Do not connect the short analog-ground strip on the Pin 1 side of the IC to the ground plane or any other ground. A short connection between this strip and AGND minimizes noise coupled to the reference and compensation capacitors. All V+ pins on plastic DIP and wide SO packages are connected to a lead frame designed for low thermal resistance. For maximum heatsinking, solder Pins 4, 5, 12, and 13 directly to a large copper trace. For $\pm 12V$ operation, cut the thin trace connected to 12/15 and install jumper, J1.

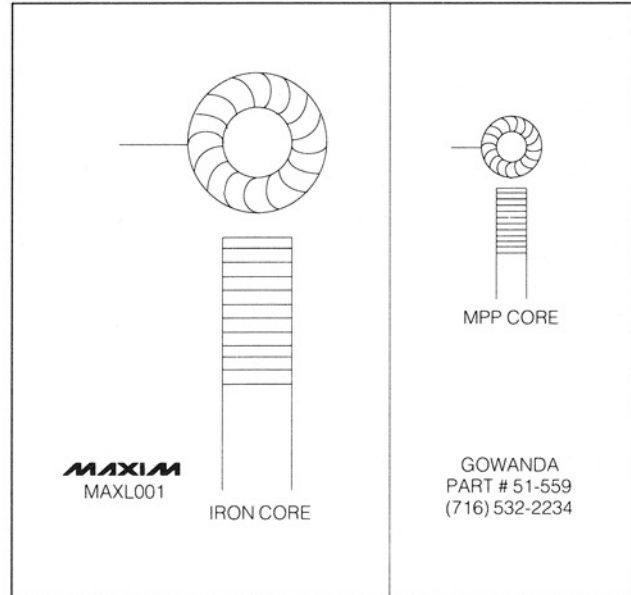

Figure 5. 100 μ H Low-EMI Inductors for 3W Supplies (Actual Sizes) (See Table 1)

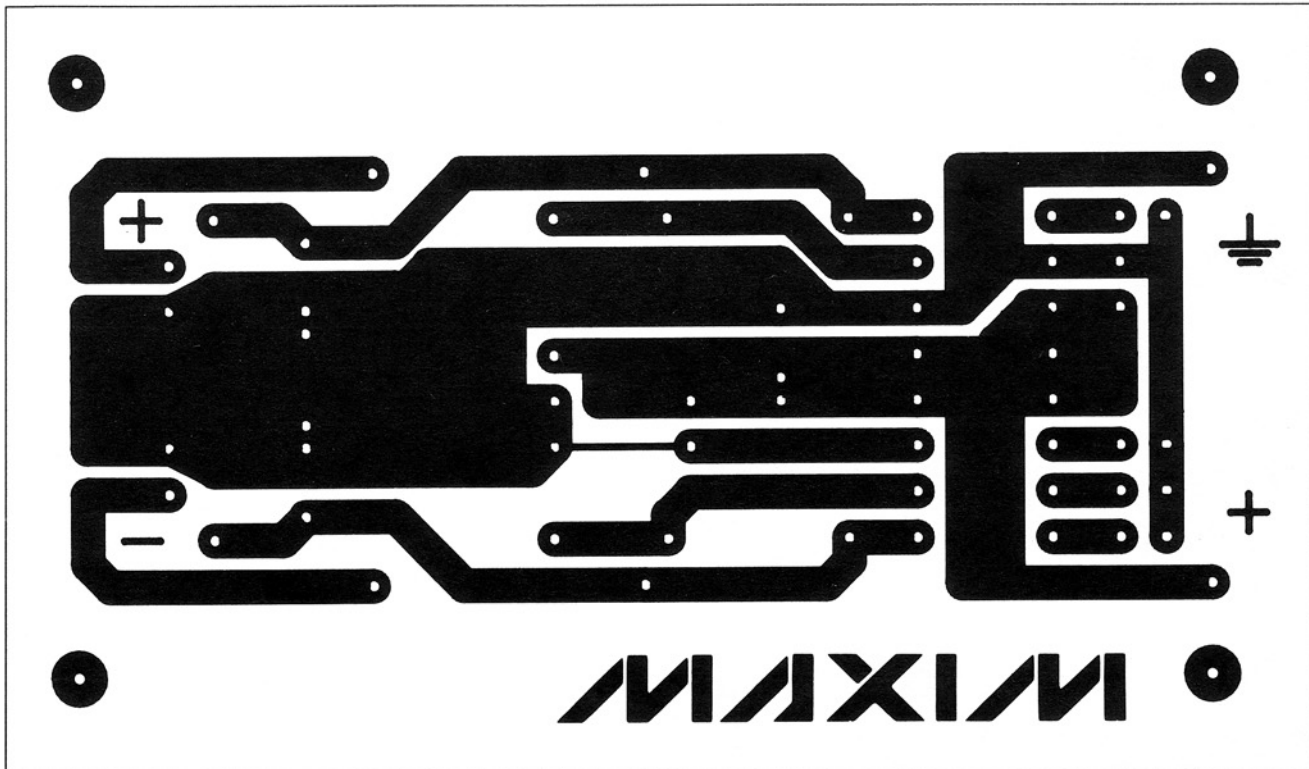

Figure 6. PC Layout for Circuit of Figure 4 Using MAXL001/MAXC001 (2X Scale)

Dual-Output, Switch-Mode Regulator (+5V to ±15V or ±12V)

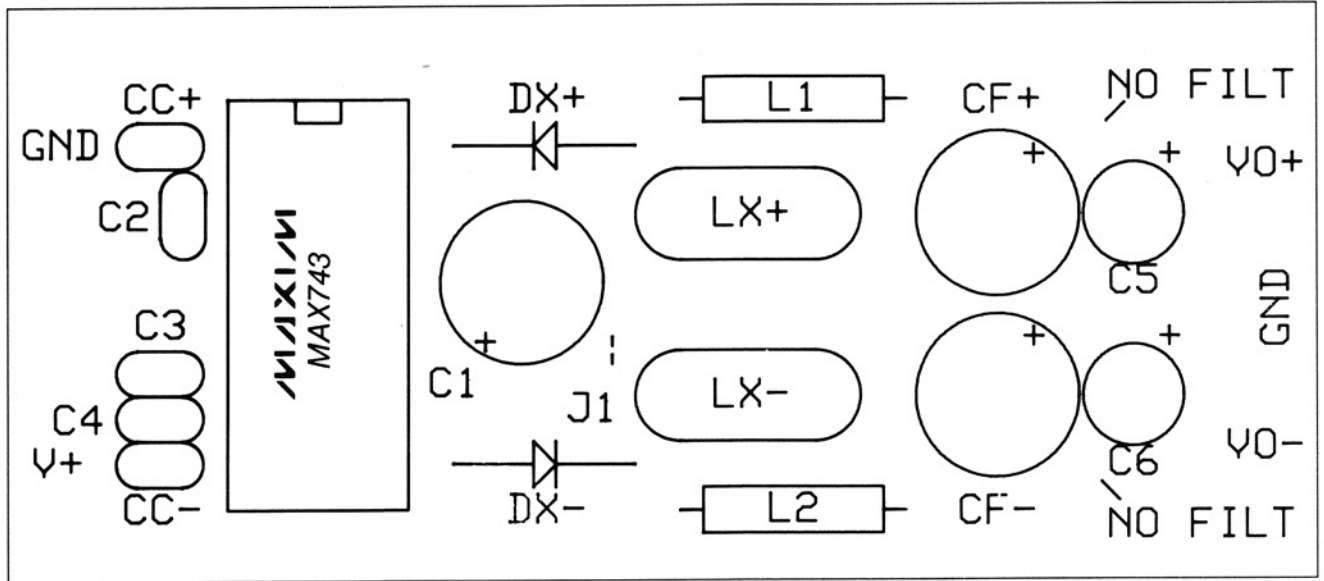

Figure 7. Component Placement Diagram for PC Layout of Figure 6

Table 2. Trouble Shooting Chart

SYMPTOM	CORRECTION
Unstable Output. Noise or jitter on output ripple waveform. Scope may not trigger correctly.	<p>Loop stability problem.</p> <p>A. CC+ or CC- disconnected.</p> <p>B. EMI: Move inductor away from IC or use shielded inductors. Keep noise sources away from CC- and CC+.</p> <p>C. Grounding: Tie AGND directly to the filter capacitor ground lead. Ensure that current spikes from GND do not cause noise at AGND or any of the comp capacitor or reference bypass ground leads. Use wide PC traces or a ground plane.</p> <p>D. Bypass: Tie 1.0µF ceramic or larger between AGND and VREF. Use 22µF tantalum to bypass the input right at AV+. If there is high source resistance, 1000µF or more may be required.</p> <p>E. Current Limiting: Reduce load currents. Ensure that inductors are not saturating.</p>
Noisy Output. Switching is steady, but large inductive spikes are seen at the outputs.	<p>A. Ground noise: Probe ground is picking up switch noise. Reduce probe ground lead length (use probe tip shield).</p> <p>B. Poor HF response: Add ceramic or tantalum capacitors in parallel with output filter capacitors.</p>
Self-destruction. Parts die on power-up.	<p>A. Input overvoltage: Never apply more than +6V to V+ in ±15V mode or +7V in ±12V mode.</p> <p>B. FB+ or FB- disconnected or shorted. This causes runaway and output overvoltage.</p> <p>C. CC+ or CC- shorted.</p> <p>D. Filter capacitor disconnected.</p>
Poor Efficiency. Supply current is high. Output will not drive heavy loads.	<p>A. Inductor saturation: Peak currents exceed coil ratings.</p> <p>B. Inductor value too low or too high.</p> <p>C. Switching losses: Diode is slow or has high forward voltage. Inductor has high DC resistance. Excess capacitance at LX nodes.</p> <p>D. Inductor core losses: Eddy currents cause self-heating in some core materials.</p> <p>E. Loop instability: See Unstable Output above.</p>
No Output. +VO = 5V or less, -VO = 0V.	<p>A. Check connections. VREF should be +2V.</p> <p>B. When input voltage is less than +4.2V, undervoltage lock-out is enabled.</p>
No Switching. ±VO are correct, but no waveform is seen at LX+ or LX-.	Output is unloaded. Apply ±10mA or greater load to observe waveform.

Dual-Output, Switch-Mode Regulator (+5V to $\pm 15V$ or $\pm 12V$)

MAX743EVKIT Power-Supply Evaluation Kit (+5V to $\pm 15V$ or $\pm 12V$)

Description

The MAX743EVKIT Evaluation Kit demonstrates the output capabilities and noise performance of the MAX743 standard application circuit (Figure 1). The kit includes main switching components identical to those found in the high-volume production kit described on page 11 (MAX743CPEKIT). With a few quick modifications, the circuit can also serve as a low-noise test bed to evaluate other components, such as the miniature MPP toroid inductor of Figure 5. The kit includes optional Pi filters shown in the Functional Diagram (Figure 4), which reduce output noise to less than 2mVp-p.

Evaluation Kit Contents

- (1) Single-Sided FR4 PC Board with Low-Noise Layout
- (1) MAX743CPE Plastic DIP IC
- (2) MAXL001 Toroid Inductors (LX+, LX-)
- (2) 1N5817 Schottky Diodes (DX+, DX-)
- (3) MAXC001 Filter and Bypass Capacitors (C1, CF+, CF-)
- (1) 0.1 μ F Ceramic Capacitor (C2)
- (2) 0.01 μ F Ceramic Capacitors (CC+, CC-)
- (1) 10 μ F Tantalum Capacitor (C3)
- (2) 2.2 μ F Tantalum Capacitors (Pi Filter: C5, C6)
- (2) 25 μ H Bobbin Inductors (Pi Filter: L1, L2)
- (1) 1 Ω 1/2W Carbon Resistor
- (2) 180 Ω 2W Carbon Resistors

Evaluation Kit Assembly and Test Instructions

Tools: Soldering iron, rosin-core solder, 22 AWG stranded hookup wire, side cutters, wire strippers, utility knife, +5V @ 1A supply, oscilloscope, 10X probe, and a DC voltmeter.

1. Build Circuit. Assemble the PC board according to the component placement diagram of Figure 7 and the schematic of Figure 4. 3 resistors will be left over (and used for testing). The extra holes near LX and CF are options for nonstandard component sizes. Do not install jumper, J1, or C4.

2. Apply Power. Apply a +5V source with 1A load capability to V+, and measure the outputs. CAUTION: Measure the source carefully before applying power because overvoltage may damage the device. Be careful while handling the board to avoid shorting CC+ and CC- while power is applied.

3. Load Outputs. Connect a 180 Ω 2W resistor across each output to observe full-load characteristics. The oscillator can be monitored indirectly by observing, via a scope probe, the inductive-switching waveforms on LX- or LX+. Some ringing at these nodes is normal.

4. Observe Noise. Move the output hookup wire connections from VO to the terminals marked NO FILT, and remove the 2.2 μ F capacitors (C5 and C6) to route the outputs around the small inductors. This demonstrates performance without extra filtering components. The 25 μ H bobbin inductor has a maximum resistance of 1.5 Ω , so the filter can introduce 150mV of added load regulation error in $\pm 15V$ mode (100mA x 1.5 Ω).

MAX743

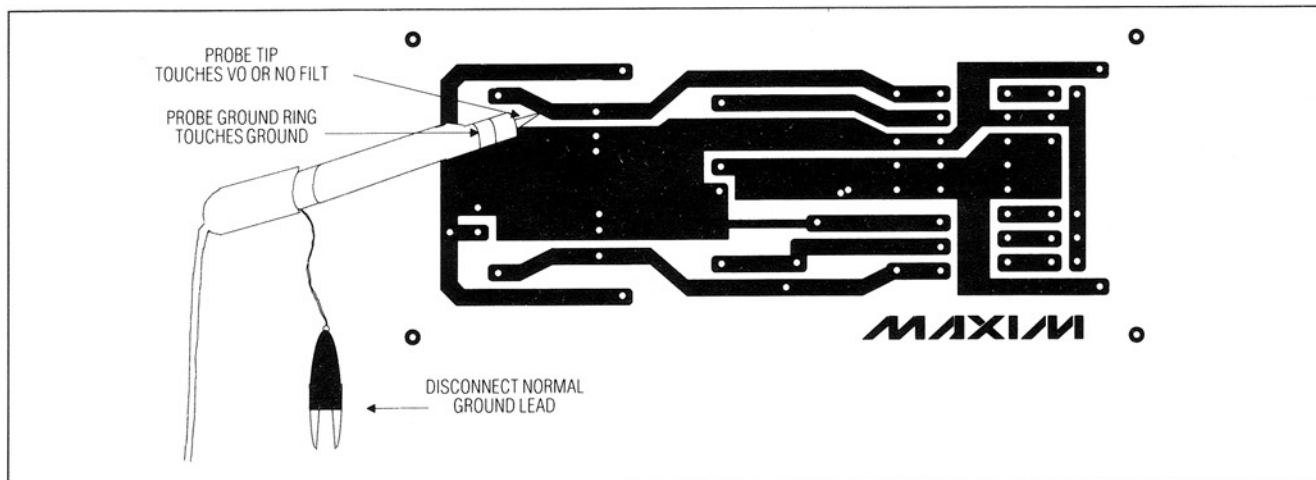

Figure 8. Noise Measurement

Dual-Output, Switch-Mode Regulator (+5V to $\pm 15V$ or $\pm 12V$)

5. Noise: Real or Not? A very short scope probe ground lead **must** be used to eliminate induced switching noise unless the board is placed in a shielded enclosure. Many probes have a ground ring near the tip (underneath the probe tip cover) normally used to insert the tip into a BNC jack. Place the probe so this probe ground ring touches the filter capacitor ground lead while the probe tip touches VO (Figure 8). Also, ground noise can often be reduced by connecting the case (earth) ground of the +5V source to circuit ground.

6. Observe Inductor-Current Waveform. Insert the 1Ω resistor provided between the LX- inductor and ground. Put the scope probe on the resistor (DC coupling). At full load, the inductor current will not decay to 0 with each cycle, and the waveform will appear as a triangle superimposed on a large (400mA) negative DC pedestal.

7. Verify Feedback Action. Varying the supply voltage causes distinct changes in duty cycle, which can be seen in the inductor-current waveform. If a decade resistor box or power rheostat is available, overcurrent protection can be exercised. The current-limit circuit functions as an output power limiter, so as load resistance is reduced, the output voltage gradually decreases.

Soft-Start

Normally, the Soft-Start pin (SS) can be left open. However, to limit surge current at start-up, a capacitor can be connected between SS and ground.

As shown in Figure 10, the peak switch current limit is a function of the voltage at the Soft-Start pin. The SS pin is connected to a $5\mu A$ current source that is diode clamped to 2.6V, so the duration of soft-start current limiting can be set by attaching a capacitor between SS and ground. Additionally, the fault conditions that normally disable the IC also turn on an N-Channel MOSFET and rapidly discharge the SS capacitor to ground (Figure 11).

Fault Conditions Enabling SS Reset

- Undervoltage Lock-out
- Thermal Shutdown
- VREF shorted to GND or supply
- VREF losing regulation

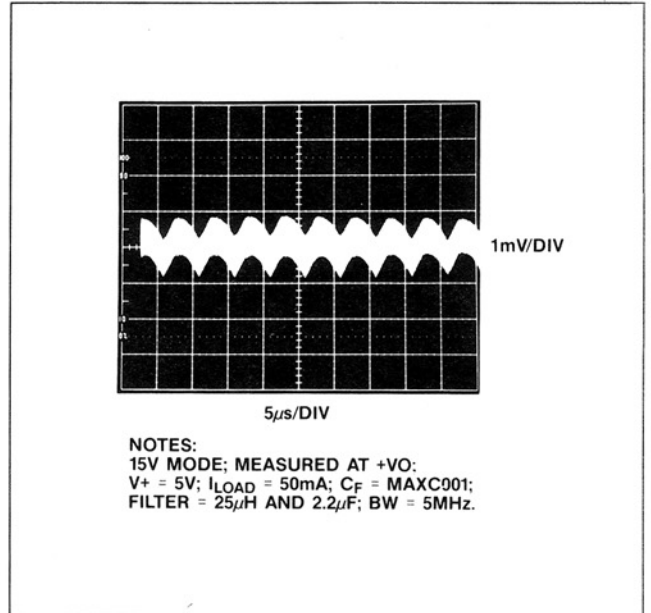

Figure 9. Output Noise Voltage with Pi Filter

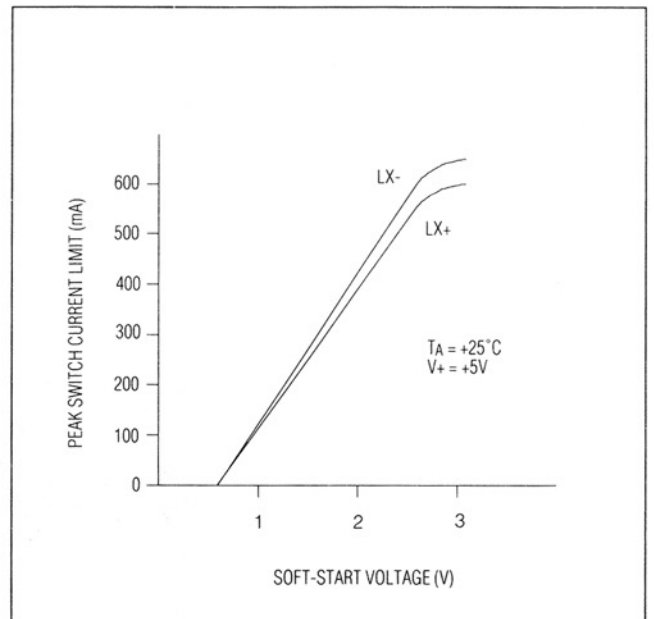

Figure 10. Typical Peak Switch Current Limit vs. Soft-Start Voltage

Dual-Output, Switch-Mode Regulator (+5V to ±15V or ±12V)

Chip Topography

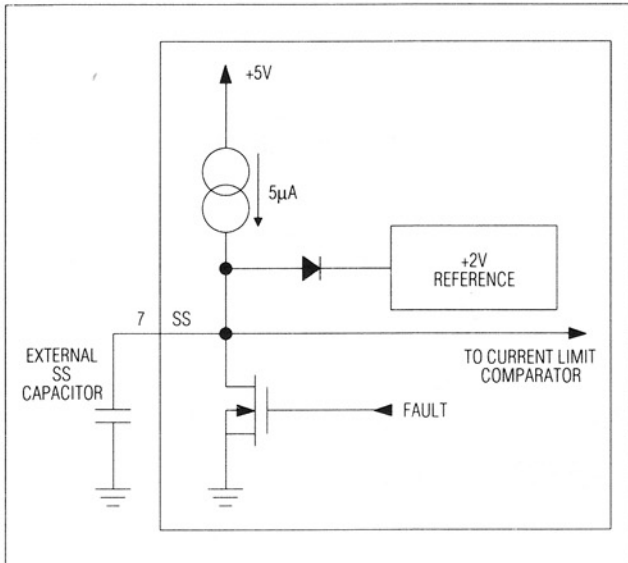
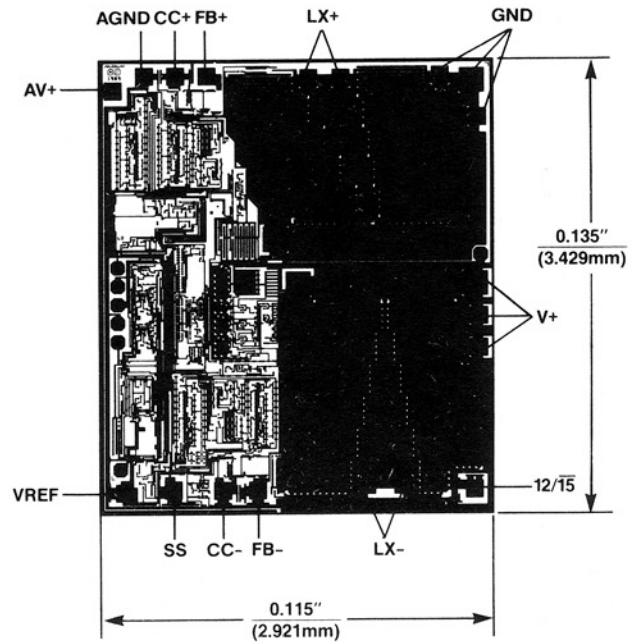

Figure 11. Soft-Start Equivalent Circuit



MAX743

Production and Evaluation Kits

Production kits for high-volume manufacturing as well as evaluation kits for prototyping can be ordered directly from Maxim. Both kits include key external components, such as MAXL001 low-loss iron-powder inductors and MAXC001 low-ESR capacitors, but the evaluation kit also includes a PC board, optional Pi filter components, and compensation capacitors. MAXL001 and MAXC001 can also be ordered individually. The production kit is available in commercial and extended temperature ranges.

Production Kit Contents

- (1) MAX743 Integrated Circuit (Plastic DIP)
- (3) MAXC001 150µF Capacitors
- (2) MAXL001 100µH Inductors
- (2) 1N5817 Schottky Rectifiers

Ordering Information (continued)

PART	DESCRIPTION
MAX743EVKIT	Evaluation Kit
MAX743CPEKIT	Production Kit (0°C to +70°C)
MAX743EPEKIT	Production Kit (-25°C to +85°C)
MAXL001	100µH Inductor
MAXC001	150µF Capacitor

Dual-Output, Switch-Mode Regulator (+5V to ±15V or ±12V)

Package Information

(The package drawing(s) in this data sheet may not reflect the most current specifications. For the latest package outline information go to www.maxim-ic.com/packages.)

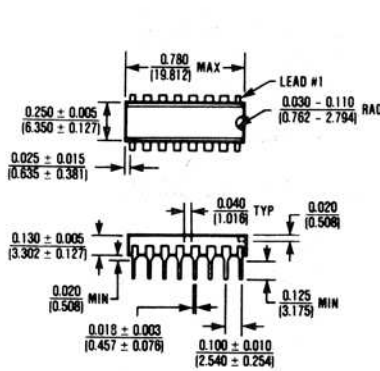

16 Lead Plastic DIP (PE)
 $\theta_{JA} = 135^{\circ}\text{C/W}$
 $\theta_{JC} = 65^{\circ}\text{C/W}$

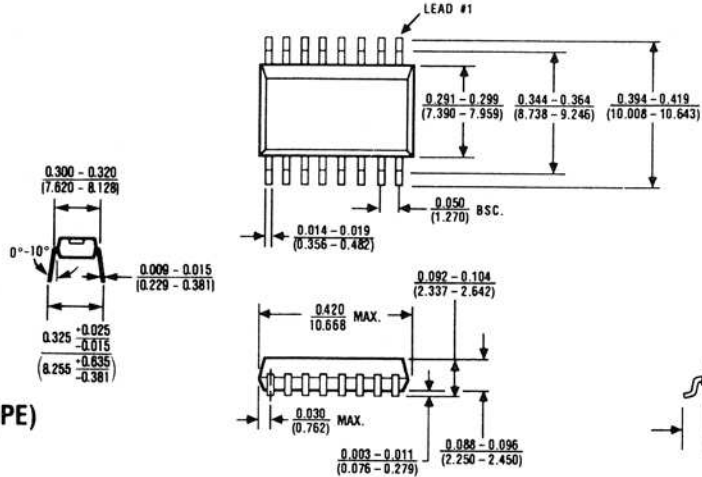

16 Lead Small Outline, Wide (WE)
 $\theta_{JA} = 105^{\circ}\text{C/W}$
 $\theta_{JC} = 60^{\circ}\text{C/W}$

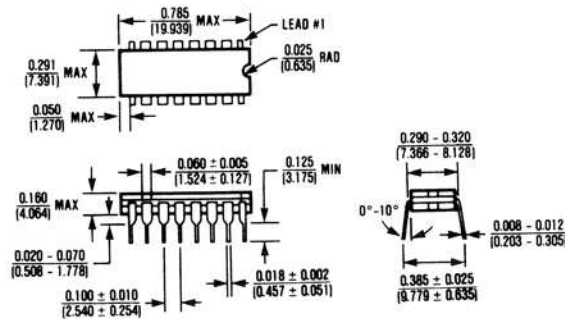

16 Lead Cerdip (JE)
 $\theta_{JA} = 100^{\circ}\text{C/W}$
 $\theta_{JC} = 50^{\circ}\text{C/W}$

Maxim cannot assume responsibility for use of any circuitry other than circuitry entirely embodied in a Maxim product. No circuit patent licenses are implied. Maxim reserves the right to change the circuitry and specifications without notice at any time.