



Chipsmall Limited consists of a professional team with an average of over 10 year of expertise in the distribution of electronic components. Based in Hongkong, we have already established firm and mutual-benefit business relationships with customers from,Europe,America and south Asia,supplying obsolete and hard-to-find components to meet their specific needs.

With the principle of “Quality Parts,Customers Priority,Honest Operation,and Considerate Service”,our business mainly focus on the distribution of electronic components. Line cards we deal with include Microchip,ALPS,ROHM,Xilinx,Pulse,ON,Everlight and Freescale. Main products comprise IC,Modules,Potentiometer,IC Socket,Relay,Connector.Our parts cover such applications as commercial,industrial, and automotives areas.

We are looking forward to setting up business relationship with you and hope to provide you with the best service and solution. Let us make a better world for our industry!



Contact us

Tel: +86-755-8981 8866 Fax: +86-755-8427 6832

Email & Skype: info@chipsmall.com Web: www.chipsmall.com

Address: A1208, Overseas Decoration Building, #122 Zhenhua RD., Futian, Shenzhen, China



DATA SHEET

SKY13251-349, SKY13251-349LF: SP3T Switch for Bluetooth® and 802.11b, g

Applications

- 802.11b, g
- Bluetooth®
- Zigbee™
- TDMA/GSM/EDGE CDMA/WCDMA
- Other short-range wireless applications

Features

- Positive low voltage control (0/+2.4 V)
- Low insertion loss (<0.5 dB @ 2.5 GHz)
- High isolation RF2, RF3 paths (29 dB @ 2.5 GHz and 27 dB @ 2.5 GHz)
- Miniature QFN-8 lead exposed paddle 2 x 2 mm
- PHEMT process
- Available lead (Pb)-free and RoHS-compliant MSL-1 @ 260 °C per JEDEC J-STD-020

Description

The SKY13251-349 is a PHEMT GaAs IC SP3T switch in a 2 x 2 mm QFN-8E package. The high isolation, low loss, small size and low cost features make this switch ideal for isolating Bluetooth® from 802.11b, g and designs that require combining TDMA, GSM, EDGE, CDMA, WCDMA with other short-range wireless applications. This switch is also available in a lead (Pb)-free package that is fully compliant with current RoHS requirements.

The SKY12351-349 employs an asymmetrical design for improved performance as a transmit-receive switch. The path between the RF common (RFC) and RF1 is optimized for low loss transmit use, while the remaining two paths, RFC to RF2 and RFC to RF3, are optimized to produce higher isolation in receiver signal paths.

A fully populated evaluation board is available.

Simplified Block Diagram

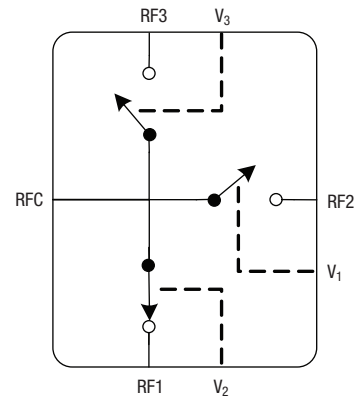

NEW Skyworks offers lead (Pb)-free, RoHS (Restriction of Hazardous Substances)-compliant packaging.

Electrical Specifications at 25 °C (0, +3 V)

$Z_0 = 50 \Omega$, unless otherwise noted

| Parameter | Condition | Frequency | Min. | Typ. | Max. | Unit |
|---------------------------------------|--------------|-------------|------|------|------|------|
| Insertion loss | RFC-RF1 | LF-1.0 GHz | | 0.35 | 0.40 | dB |
| | | 1.0-2.0 GHz | | 0.40 | 0.50 | dB |
| | | 2.0-3.0 GHz | | 0.45 | 0.60 | dB |
| | RFC-RF2, RF3 | LF-1.0 GHz | | 0.35 | 0.40 | dB |
| | | 1.0-2.0 GHz | | 0.50 | 0.60 | dB |
| | | 2.0-3.0 GHz | | 0.60 | 0.70 | dB |
| Isolation | RFC-RF1 | LF-1.0 GHz | 22 | 24 | | dB |
| | | 1.0-2.0 GHz | 15 | 18 | | dB |
| | | 2.0-3.0 GHz | 12 | 15 | | dB |
| | RFC-RF2, RF3 | LF-1.0 GHz | 25 | 29 | | dB |
| | | 1.0-2.0 GHz | 23 | 27 | | dB |
| | | 2.0-3.0 GHz | 23 | 27 | | dB |
| Return loss (insertion loss state) | RFC-RF1 | LF-1.0 GHz | | 24 | | dB |
| | | 1.0-2.0 GHz | | 25 | | dB |
| | | 2.0-3.0 GHz | | 25 | | dB |
| | RFC-RF2, RF3 | LF-1.0 GHz | | 22 | | dB |
| | | 1.0-2.0 GHz | | 19 | | dB |
| | | 2.0-3.0 GHz | | 20 | | dB |

LF = low frequency.

The low frequency limit is set by the value of the DC blocking capacitors used external to the part.

Operating Characteristics at 25 °C (0, +3 V)

$Z_0 = 50 \Omega$, unless otherwise noted

| Parameter | Condition | Frequency | Min. | Typ. | Max. | Unit |
|---------------------------------------|---|-----------|------|------|-----------|--------------------|
| Switching characteristics | | | | | | |
| Rise | 10% to 90% RF | | | 50 | | ns |
| Fall | 90% to 10% RF | | | 25 | | ns |
| On | 50% V_{CTL} to 90% RF | | | 50 | | ns |
| Off | 50% V_{CTL} to 10% RF | | | 50 | | ns |
| Input power for -1.0 dB compression | $V_{CTL} = 0/3 V$ | 0.5-3 GHz | | 25 | | dBm |
| Intermodulation intercept point (IP3) | Two-tones 900 MHz, 5 MHz spacing +10 dBm each tone | 0.5-3 GHz | | 46 | | dBm |
| Control voltages | | | | | | |
| High | | | 2.3 | | 5.5 | V |
| Low | | | 0 | | 0.2 | V |
| Control port input current | $V_{CTL} = 3 V$ $V_{CTL} = 0 V$ | | | | 100 20 | μA μA |

Typical Performance Data

$Z_0 = 50 \Omega$, $T_A = 25^\circ\text{C}$, unless otherwise noted

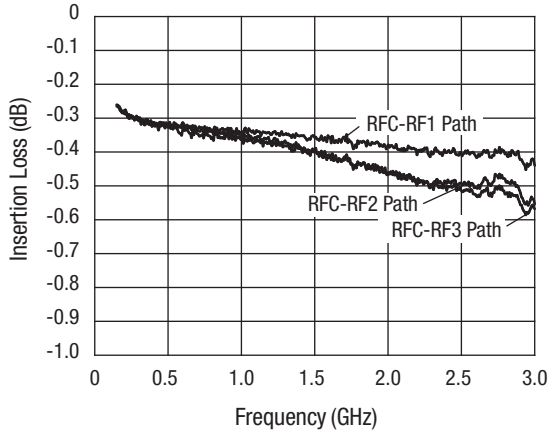

Insertion Loss vs. Frequency

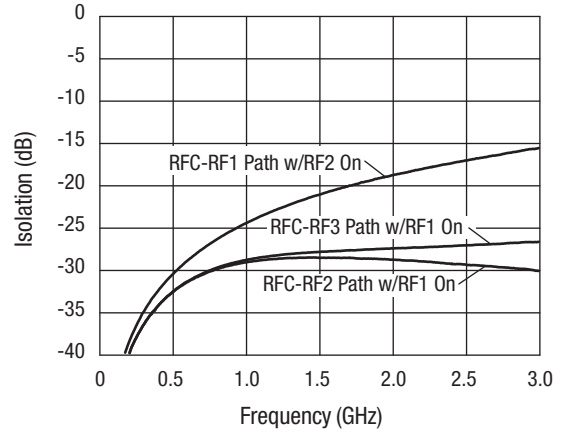

Isolation vs. Frequency

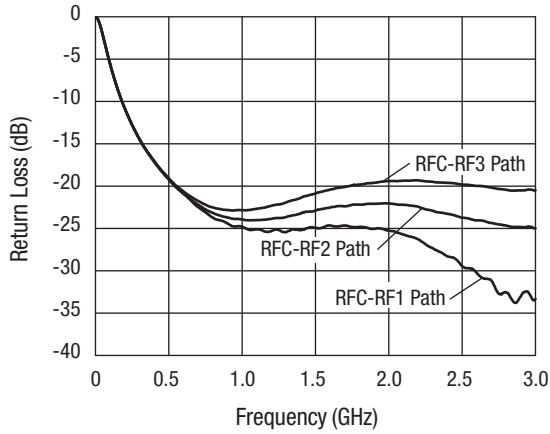

Return Loss vs. Frequency

Absolute Maximum Ratings

| Characteristic | Value |
|---|--|
| RF input power ($V_{CTL} = 0/7\text{ V}$) | 1 W, $f > 500\text{ MHz}$ 0.5 W, $f < 500\text{ MHz}$ |
| Control voltage | -0.2 V, +8 V |
| Operating temperature | -40 °C to +85 °C |
| Storage temperature | -65 °C to +150 °C |
| Θ_{JC} | 45 °C/W |

Performance is guaranteed only under the conditions listed in the specifications table and is not guaranteed under the full range(s) described by the Absolute Maximum specifications. Exceeding any of the absolute maximum/minimum specifications may result in permanent damage to the device and will void the warranty.

CAUTION: Although this device is designed to be as robust as possible, ESD (Electrostatic Discharge) can damage this device. This device must be protected at all times from ESD. Static charges may easily produce potentials of several kilovolts on the human body or equipment, which can discharge without detection. Industry-standard ESD precautions must be employed at all times.

Pin Out (Top View)

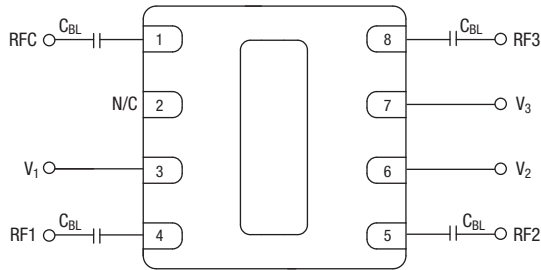

$C_{BL} = 47$ pF for operation >500 MHz.
Exposed paddle must be grounded.

Truth Table

| V_1 | V_2 | V_3 | RFC-RF1 | RFC-RF2 | RFC-RF3 |
|-------|-------|-------|----------------|----------------|----------------|
| 1 | 0 | 0 | Isolation | Insertion loss | Isolation |
| 0 | 1 | 0 | Insertion loss | Isolation | Isolation |
| 0 | 0 | 1 | Isolation | Isolation | Insertion loss |

All other logic conditions put the switch in an undefined state.
"0" = 0 to 0.2 V.
"1" = 2.3 to 5.5 V.

QFN 8E 2 x 2 (-349)

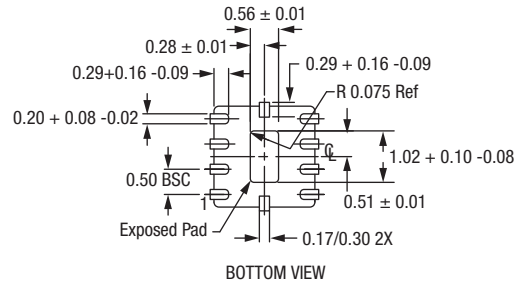
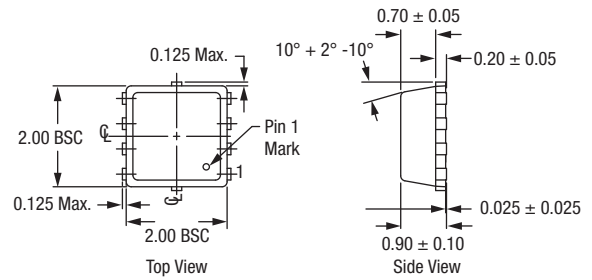

Recommended Solder Reflow Profiles

Refer to the ["Recommended Solder Reflow Profile"](#) Application Note.

Tape and Reel Information

Refer to the ["Discrete Devices and IC Switch/Attenuators Tape and Reel Package Orientation"](#) Application Note.

Copyright © 2002, 2003, 2004, 2005, 2006, 2007, Skyworks Solutions, Inc. All Rights Reserved.

Information in this document is provided in connection with Skyworks Solutions, Inc. ("Skyworks") products or services. These materials, including the information contained herein, are provided by Skyworks as a service to its customers and may be used for informational purposes only by the customer. Skyworks assumes no responsibility for errors or omissions in these materials or the information contained herein. Skyworks may change its documentation, products, services, specifications or product descriptions at any time, without notice. Skyworks makes no commitment to update the materials or information and shall have no responsibility whatsoever for conflicts, incompatibilities, or other difficulties arising from any future changes.

No license, whether express, implied, by estoppel or otherwise, is granted to any intellectual property rights by this document. Skyworks assumes no liability for any materials, products or information provided hereunder, including the sale, distribution, reproduction or use of Skyworks products, information or materials, except as may be provided in Skyworks Terms and Conditions of Sale.

THE MATERIALS, PRODUCTS AND INFORMATION ARE PROVIDED "AS IS" WITHOUT WARRANTY OF ANY KIND, WHETHER EXPRESS, IMPLIED, STATUTORY, OR OTHERWISE, INCLUDING FITNESS FOR A PARTICULAR PURPOSE OR USE, MERCHANTABILITY, PERFORMANCE, QUALITY OR NON-INFRINGEMENT OF ANY INTELLECTUAL PROPERTY RIGHT; ALL SUCH WARRANTIES ARE HEREBY EXPRESSLY DISCLAIMED. SKYWORKS DOES NOT WARRANT THE ACCURACY OR COMPLETENESS OF THE INFORMATION, TEXT, GRAPHICS OR OTHER ITEMS CONTAINED WITHIN THESE MATERIALS. SKYWORKS SHALL NOT BE LIABLE FOR ANY DAMAGES, INCLUDING BUT NOT LIMITED TO ANY SPECIAL, INDIRECT, INCIDENTAL, STATUTORY, OR CONSEQUENTIAL DAMAGES, INCLUDING WITHOUT LIMITATION, LOST REVENUES OR LOST PROFITS THAT MAY RESULT FROM THE USE OF THE MATERIALS OR INFORMATION, WHETHER OR NOT THE RECIPIENT OF MATERIALS HAS BEEN ADVISED OF THE POSSIBILITY OF SUCH DAMAGE.

Skyworks products are not intended for use in medical, lifesaving or life-sustaining applications, or other equipment in which the failure of the Skyworks products could lead to personal injury, death, physical or environmental damage. Skyworks customers using or selling Skyworks products for use in such applications do so at their own risk and agree to fully indemnify Skyworks for any damages resulting from such improper use or sale.

Customers are responsible for their products and applications using Skyworks products, which may deviate from published specifications as a result of design defects, errors, or operation of products outside of published parameters or design specifications. Customers should include design and operating safeguards to minimize these and other risks. Skyworks assumes no liability for applications assistance, customer product design, or damage to any equipment resulting from the use of Skyworks products outside of stated published specifications or parameters.

Skyworks, the Skyworks symbol, and "Breakthrough Simplicity" are trademarks or registered trademarks of Skyworks Solutions, Inc., in the United States and other countries. Third-party brands and names are for identification purposes only, and are the property of their respective owners. Additional information, including relevant terms and conditions, posted at www.skyworksinc.com, are incorporated by reference.