



Chipsmall Limited consists of a professional team with an average of over 10 year of expertise in the distribution of electronic components. Based in Hongkong, we have already established firm and mutual-benefit business relationships with customers from,Europe,America and south Asia,supplying obsolete and hard-to-find components to meet their specific needs.

With the principle of “Quality Parts,Customers Priority,Honest Operation,and Considerate Service”,our business mainly focus on the distribution of electronic components. Line cards we deal with include Microchip,ALPS,ROHM,Xilinx,Pulse,ON,Everlight and Freescale. Main products comprise IC,Modules,Potentiometer,IC Socket,Relay,Connector.Our parts cover such applications as commercial,industrial, and automotives areas.

We are looking forward to setting up business relationship with you and hope to provide you with the best service and solution. Let us make a better world for our industry!



Contact us

Tel: +86-755-8981 8866 Fax: +86-755-8427 6832

Email & Skype: info@chipsmall.com Web: www.chipsmall.com

Address: A1208, Overseas Decoration Building, #122 Zhenhua RD., Futian, Shenzhen, China



DATA SHEET

SKY13350-385LF: 0.01 to 6.0 GHz GaAs SPDT Switch

Applications

- WLAN 802.11 a/b/g networks
- WLAN repeaters
- ISM band radios
- Low power transmit receive systems

Features

- Positive voltage control (0/1.6 V to 0/5.0 V)
- Broadband frequency range: 0.01 to 6.0 GHz
- Very low insertion loss: 0.35 dB typical @ 3 GHz
- High isolation, 25 dB typical @ 3 GHz
- Excellent linearity performance, $IP0.5dB = +30$ dBm with control voltage = 3 V
- Ultra-miniature, MLPD (6-pin, 1 x 1 mm) package (MSL1, 260 °C per JEDEC J-STD-020)



Skyworks Green™ products are compliant with all applicable legislation and are halogen-free. For additional information, refer to *Skyworks Definition of Green™*, document number SQ04-0074.

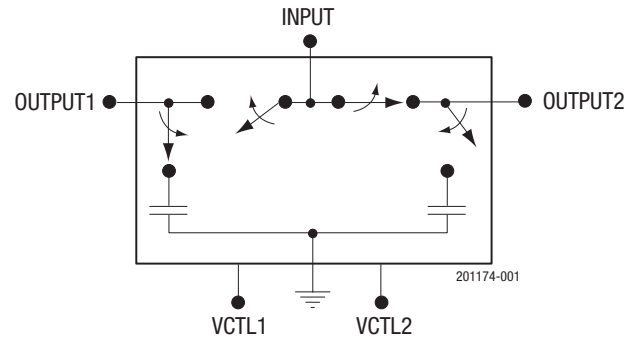

Figure 1. SKY13350-385LF Block Diagram

Description

The SKY13350-385LF is a GaAs pHEMT FET single-pole, double-throw (SPDT) switch. The switch can be used in transmit/receive applications by connecting the RF common port (INPUT, pin 6) to either the OUTPUT1 or OUTPUT2 port (pin 2 or 4, respectively) using a low loss path (i.e., a positive voltage applied to either VCTL1 or VCTL2 pins). The switch is “reflective short” on the isolated port.

The switch is manufactured in a compact, 1 x 1 mm, 6-pin exposed pad plastic Micro Leadframe Package Dual (MLPD) package.

A functional block diagram is shown in Figure 1. The pin configuration and package are shown in Figure 2. Signal pin assignments and functional pin descriptions are provided in Table 1.

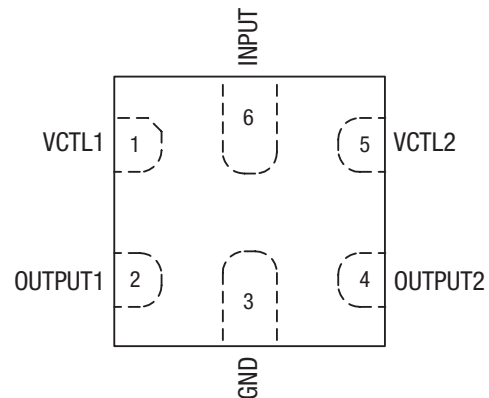

Figure 2. SKY13350-385LF Pinout (Top View)

Table 1. SKY13350-385LF Signal Descriptions

Pin	Name	Description	Pin	Name	Description
1	VCTL1	DC control voltage	4	OUTPUT2	RF port. Must be DC blocked.
2	OUTPUT1	RF port. Must be DC blocked.	5	VCTL2	DC control voltage
3	GND	Ground	6	INPUT	RF port. Must be DC blocked

Electrical and Mechanical Specifications

The absolute maximum ratings of the SKY13350-385LF are provided in Table 2. The recommended operating conditions are specified in Table 3 and electrical specifications are provided in Table 4.

Typical performance characteristics of the SKY13350-385LF are illustrated in Figures 3 through 9.

The state of the SKY13350-385LF is determined by the logic provided in Table 5.

Table 2. SKY13350-385LF Absolute Maximum Ratings

Parameter	Symbol	Minimum	Maximum	Units
Input power >500 MHz, 5 V	P _{IN}		+32	dBm
>500 MHz, 3 V			+31	dBm
Storage temperature	T _{STG}	-65	+150	°C
Operating temperature	T _{OP}	-40	+105	°C

ESD HANDLING: *Although this device is designed to be as robust as possible, electrostatic discharge (ESD) can damage this device. This device must be protected at all times from ESD when handling or transporting. Static charges may easily produce potentials of several kilovolts on the human body or equipment, which can discharge without detection. Industry-standard ESD handling precautions should be used at all times.*

Table 3. SKY13350-385LF Recommended Operating Conditions

Parameter	Symbol	Min	Typ	Max	Units
Frequency	f	0.01		6.0	GHz
Control voltage: low	V _{CTL_L}	0		0.2	V
high	V _{CTL_H}	1.6		5.0	V
Operating temperature	T _{OP}		+25		°C

Table 4. SKY13350-385LF Electrical Specifications¹**(V_{CTL} = 0 V and +2.7 V, T_{OP} = +25 °C, P_{IN} = 0 dBm, Characteristic Impedance [Z₀] = 50 Ω, Unless Otherwise Noted)**

Parameter	Symbol	Test Condition	Min	Typ	Max	Units				
Insertion loss		0.01 to 3.0 GHz		0.35	0.50	dB				
		3.0 to 6.0 GHz		0.60	0.80	dB				
Isolation		0.01 to 3.0 GHz	18	20		dB				
		3.0 to 6.0 GHz	17	18		dB				
Return loss (insertion loss state)		0.01 to 3.0 GHz		21		dB				
		3.0 to 6.0 GHz		18		dB				
Switching characteristics:										
Rise/fall time		10/90% or 90/10% RF		45		ns				
On/off time		50% V _{CTL} to 90/10% RF		45		ns				
Video feedthrough				25		mV				
0.5 dB input compression point	IP0.5dB	f = 2.45 GHz: V _{CTL} = 1.8 V V _{CTL} = 2.7 V		+25		dBm				
				+30		dBm				
		f = 5.8 GHz: V _{CTL} = 1.8 V V _{CTL} = 2.7 V		+25		dBm				
				+30		dBm				
Input IP3	IIP3	P _{IN} = +10 dBm/tone, tone spacing = 1 MHz								
							f = 2.45 GHz: V _{CTL} = 1.8 V V _{CTL} = 2.7 V	+32		dBm
								+50		dBm
							f = 5.8 GHz: V _{CTL} = 1.8 V V _{CTL} = 2.7 V	+30		dBm
								+46		dBm
							Error vector magnitude	EVM	802.11a, 54 Mbps, P _{IN} = <+24 dBm, V _{CTL} = 3.0 V	
802.11g, 54 Mbps, P _{IN} = <+25.5 dBm, V _{CTL} = 3.0 V	2.5		%							
Control voltage:										
Low	V _{CTL_L}		0		0.2	V				
High	V _{CTL_H}		1.6	2.7	5.0	V				
Supply current	I _{CC}	V _{CTL_L} = 0 V		5		μA				
		V _{CTL_H} = 5 V		5		μA				

¹ Performance is guaranteed only under the conditions listed in this table.

Typical Performance Characteristics

($V_{CTL} = 0\text{ V}$ and $+2.7\text{ V}$, $T_{OP} = +25\text{ }^{\circ}\text{C}$, $P_{IN} = 0\text{ dBm}$, Characteristic Impedance [Z_0] = $50\ \Omega$, Blocking Capacitors = 100 pF , Bypass Capacitors = 33 pF , Unless Otherwise Noted)

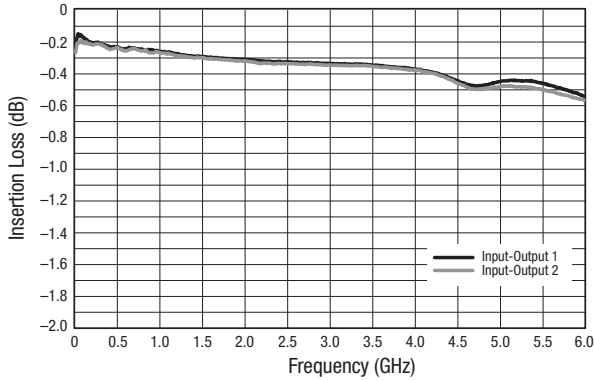

Figure 3. Typical Insertion Loss

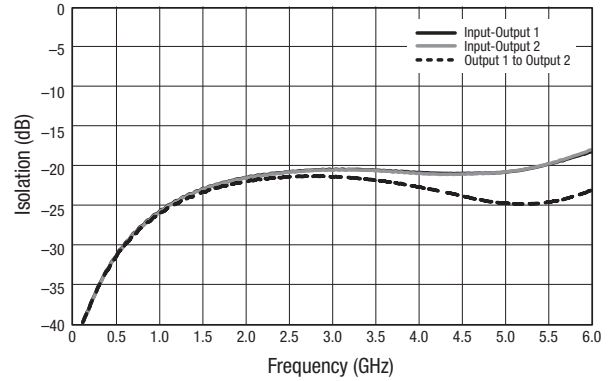

Figure 4. Typical Isolation

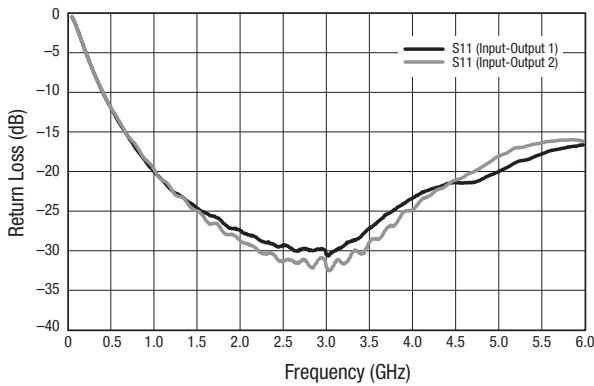

Figure 5. Typical Return Loss

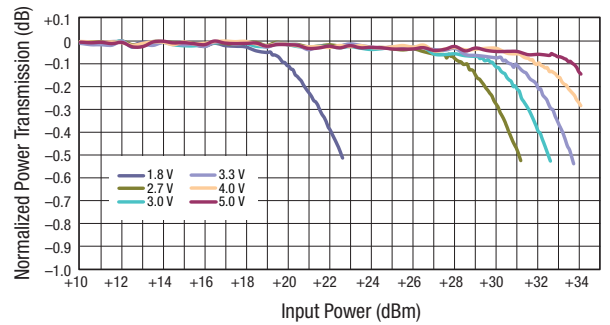

Figure 6. Compression vs Control Voltage (2450 MHz)

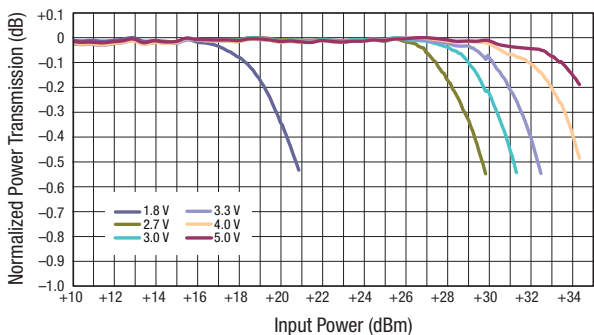

Figure 7. Compression vs Control Voltage (5.2 to 5.8 GHz)

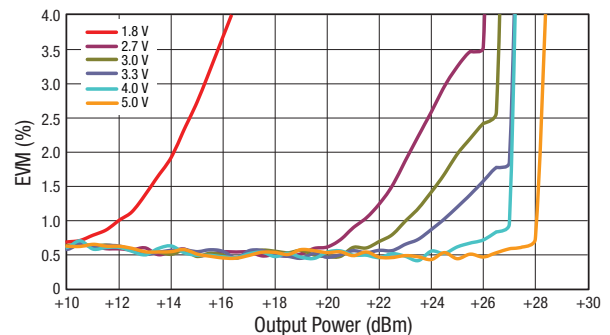

Figure 8. 802.11a EVM vs Output Power, 5.2-5.8 GHz, 54 Mbps

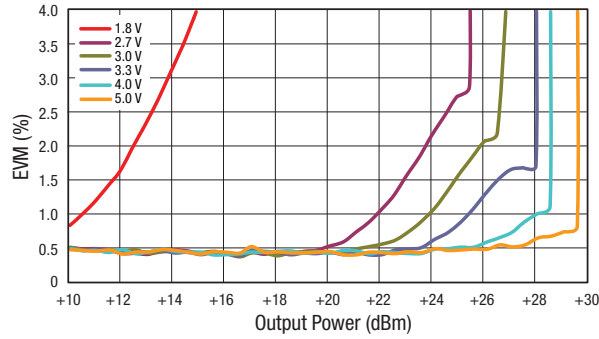

Figure 9. 802.11g EVM vs Output Power @ 2.45 GHz, 54 Mbps

Table 5. SKY13350-385LF Truth Table¹

VCTL1 (Pin 1)	VCTL2 (Pin 5)	INPUT to OUTPUT1 Path	INPUT to OUTPUT2 Path
1	0	Insertion loss	Isolation
0	1	Isolation	Insertion loss

¹ "1" = +1.6 V to +5 V. "0" = 0 V to +0.2 V.
Any state other than described in this table places the switch into an undefined state.
An undefined state will not damage the device.

Evaluation Board Description

The SKY13350-385LF Evaluation Board is used to test the performance of the SKY13350-385LF SPDT Switch. An Evaluation Board schematic diagram is provided in Figure 10. An assembly drawing for the Evaluation Board is shown in Figure 11.

Package Dimensions

The PCB layout footprint for the SKY13350-385LF is provided in Figure 12. Typical part markings are shown in Figure 13. Package dimensions are shown in Figure 14, and tape and reel dimensions are provided in Figure 15.

Package and Handling Information

Instructions on the shipping container label regarding exposure to moisture after the container seal is broken must be followed. Otherwise, problems related to moisture absorption may occur when the part is subjected to high temperature during solder assembly.

The SKY13350-385LF is rated to Moisture Sensitivity Level 1 (MSL1) at 260 °C. It can be used for lead or lead-free soldering. It can be used for lead or lead-free soldering. For additional information, refer to the Skyworks Application Note, *Solder Reflow Information*, document number 200164.

Care must be taken when attaching this product, whether it is done manually or in a production solder reflow environment. Production quantities of this product are shipped in a standard tape and reel format.

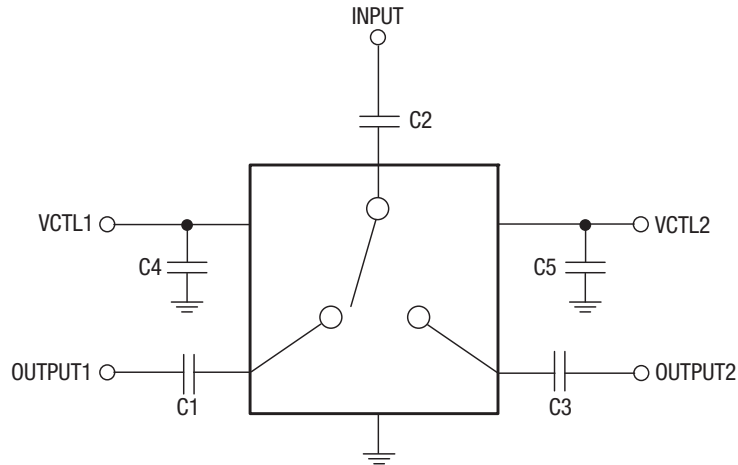

For low frequency performance, larger value blocking capacitors (>1000 pF for operation at 10 MHz) are required.

S1761a

Figure 10. SKY13350-385LF Evaluation Board Schematic

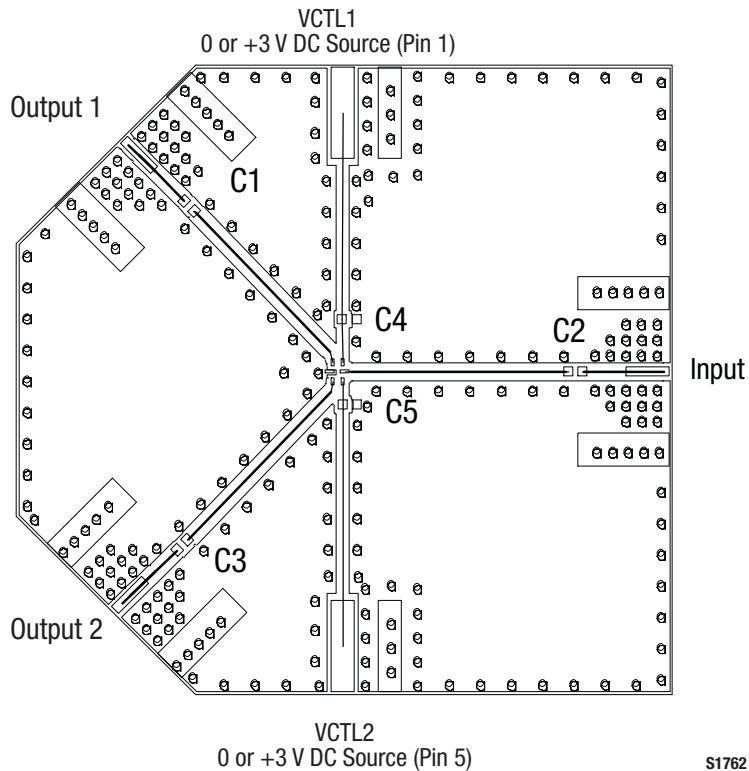

S1762

Figure 11. SKY13350-385LF Evaluation Board Assembly Diagram

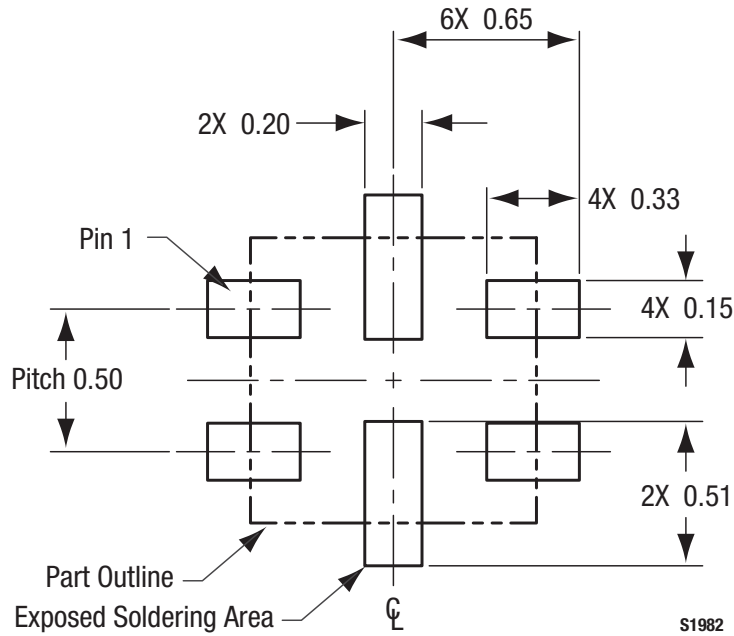

Figure 12. SKY13350-385LF PCB Layout Footprint (Top View)

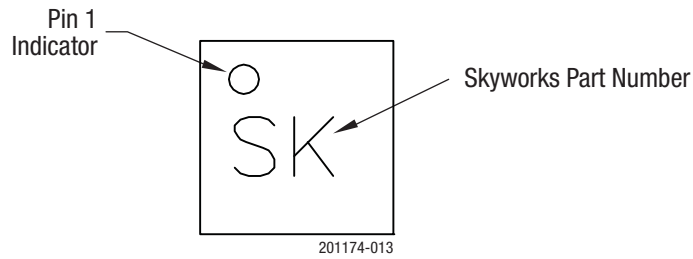
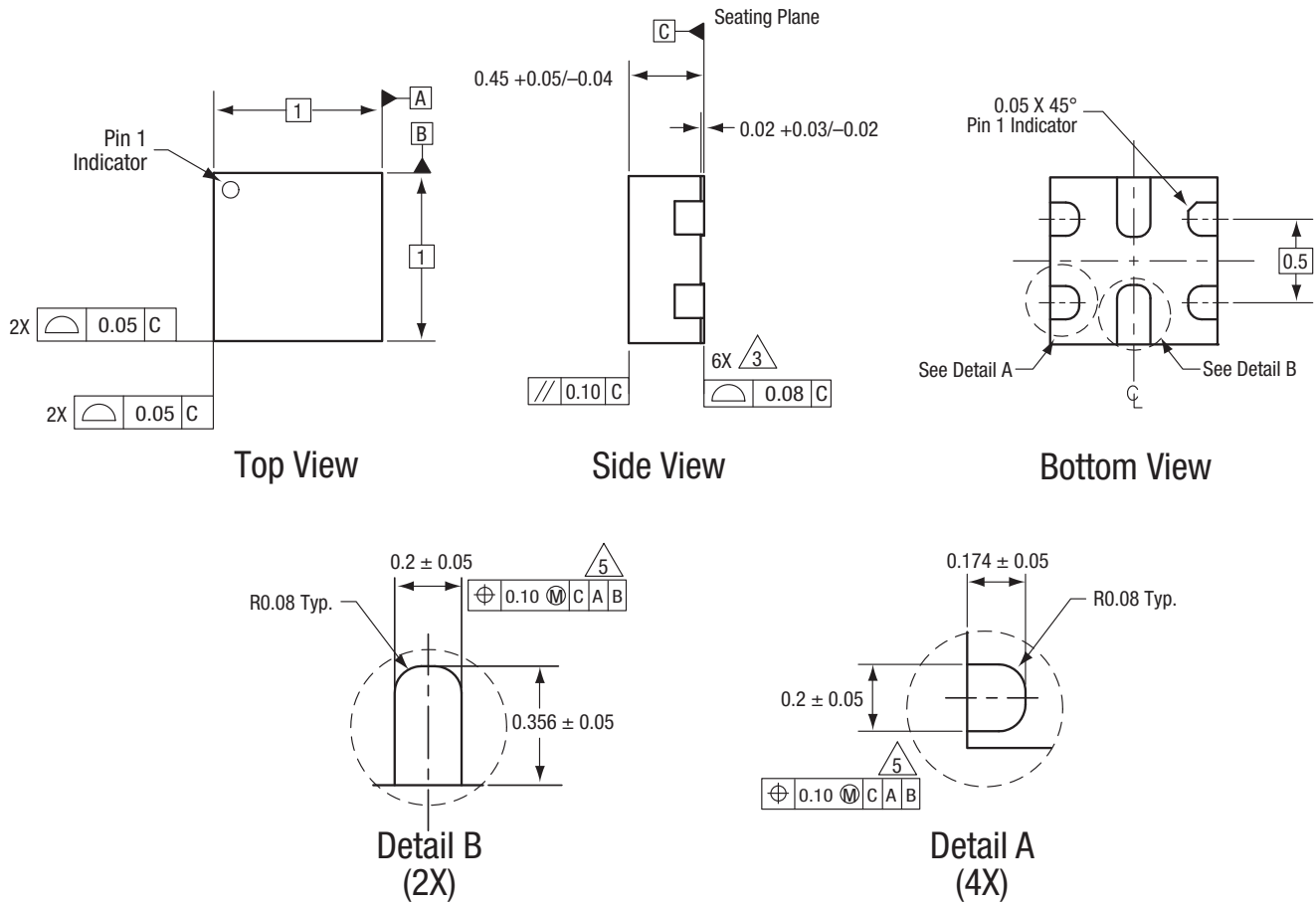

Figure 13. Typical Part Markings (Top View)



All measurements are in millimeters.
Dimensioning and tolerancing according to ASME Y14.5M-1994.

S1760

Figure 14. SKY13350-385LF Package Dimensions

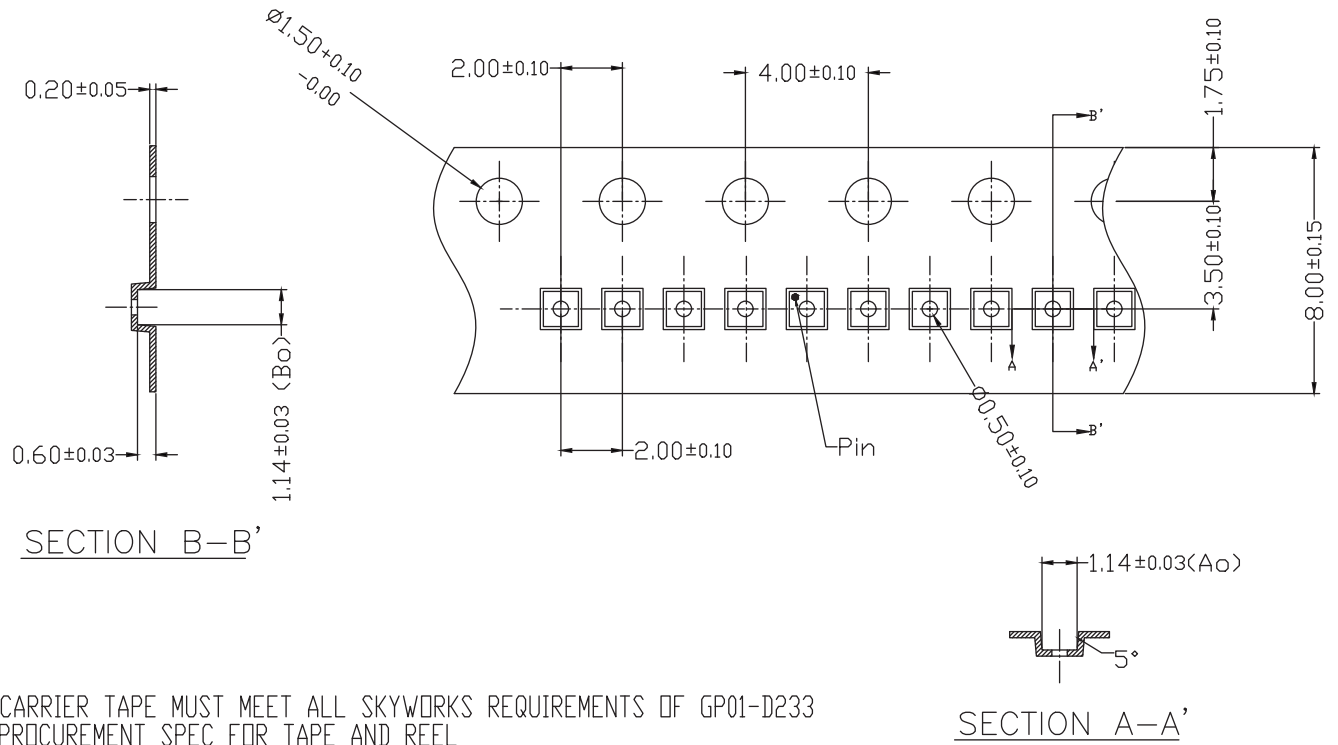

1. CARRIER TAPE MUST MEET ALL SKYWORKS REQUIREMENTS OF GP01-D233 PROCUREMENT SPEC FOR TAPE AND REEL
2. CARRIER TAPE SHALL BE BLACK CONDUCTIVE POLYCARBONATE.
3. COVER TAPE SHALL BE TRANSPARENT CONDUCTIVE MATERIAL
4. ESD-SURFACE RESISTIVITY SHALL MEET GP01-D233
5. 10 SPROCKET HOLE PITCH CUMULATIVE TOLERANCE : $\pm 0.20\text{mm}$
6. A_0 & B_0 MEASURED ON PLANE 0.30mm ABOVE THE BOTTOM OF THE POCKET.
7. ALL DIMENSIONS ARE IN MILLIMETERS.

SECTION A-A'

201174-015

Figure 15. SKY13350-385LF Tape and Reel Dimensions

Ordering Information

Model Name	Manufacturing Part Number	Evaluation Board Part Number
SKY13350-385LF SPDT Switch	SKY13350-385LF	SKY13350-385LF-EVB

Copyright © 2009-2010, 2012-2013, 2017 Skyworks Solutions, Inc. All Rights Reserved.

Information in this document is provided in connection with Skyworks Solutions, Inc. ("Skyworks") products or services. These materials, including the information contained herein, are provided by Skyworks as a service to its customers and may be used for informational purposes only by the customer. Skyworks assumes no responsibility for errors or omissions in these materials or the information contained herein. Skyworks may change its documentation, products, services, specifications or product descriptions at any time, without notice. Skyworks makes no commitment to update the materials or information and shall have no responsibility whatsoever for conflicts, incompatibilities, or other difficulties arising from any future changes.

No license, whether express, implied, by estoppel or otherwise, is granted to any intellectual property rights by this document. Skyworks assumes no liability for any materials, products or information provided hereunder, including the sale, distribution, reproduction or use of Skyworks products, information or materials, except as may be provided in Skyworks Terms and Conditions of Sale.

THE MATERIALS, PRODUCTS AND INFORMATION ARE PROVIDED "AS IS" WITHOUT WARRANTY OF ANY KIND, WHETHER EXPRESS, IMPLIED, STATUTORY, OR OTHERWISE, INCLUDING FITNESS FOR A PARTICULAR PURPOSE OR USE, MERCHANTABILITY, PERFORMANCE, QUALITY OR NON-INFRINGEMENT OF ANY INTELLECTUAL PROPERTY RIGHT; ALL SUCH WARRANTIES ARE HEREBY EXPRESSLY DISCLAIMED. SKYWORKS DOES NOT WARRANT THE ACCURACY OR COMPLETENESS OF THE INFORMATION, TEXT, GRAPHICS OR OTHER ITEMS CONTAINED WITHIN THESE MATERIALS. SKYWORKS SHALL NOT BE LIABLE FOR ANY DAMAGES, INCLUDING BUT NOT LIMITED TO ANY SPECIAL, INDIRECT, INCIDENTAL, STATUTORY, OR CONSEQUENTIAL DAMAGES, INCLUDING WITHOUT LIMITATION, LOST REVENUES OR LOST PROFITS THAT MAY RESULT FROM THE USE OF THE MATERIALS OR INFORMATION, WHETHER OR NOT THE RECIPIENT OF MATERIALS HAS BEEN ADVISED OF THE POSSIBILITY OF SUCH DAMAGE.

Skyworks products are not intended for use in medical, lifesaving or life-sustaining applications, or other equipment in which the failure of the Skyworks products could lead to personal injury, death, physical or environmental damage. Skyworks customers using or selling Skyworks products for use in such applications do so at their own risk and agree to fully indemnify Skyworks for any damages resulting from such improper use or sale.

Customers are responsible for their products and applications using Skyworks products, which may deviate from published specifications as a result of design defects, errors, or operation of products outside of published parameters or design specifications. Customers should include design and operating safeguards to minimize these and other risks. Skyworks assumes no liability for applications assistance, customer product design, or damage to any equipment resulting from the use of Skyworks products outside of stated published specifications or parameters.

Skyworks and the Skyworks symbol are trademarks or registered trademarks of Skyworks Solutions, Inc., in the United States and other countries. Third-party brands and names are for identification purposes only, and are the property of their respective owners. Additional information, including relevant terms and conditions, posted at www.skyworksinc.com, are incorporated by reference.