



Chipsmall Limited consists of a professional team with an average of over 10 year of expertise in the distribution of electronic components. Based in Hongkong, we have already established firm and mutual-benefit business relationships with customers from,Europe,America and south Asia,supplying obsolete and hard-to-find components to meet their specific needs.

With the principle of "Quality Parts,Customers Priority,Honest Operation,and Considerate Service",our business mainly focus on the distribution of electronic components. Line cards we deal with include Microchip,ALPS,ROHM,Xilinx,Pulse,ON,Everlight and Freescale. Main products comprise IC,Modules,Potentiometer,IC Socket,Relay,Connector.Our parts cover such applications as commercial,industrial, and automotives areas.

We are looking forward to setting up business relationship with you and hope to provide you with the best service and solution. Let us make a better world for our industry!



Contact us

Tel: +86-755-8981 8866 Fax: +86-755-8427 6832

Email & Skype: info@chipsmall.com Web: www.chipsmall.com

Address: A1208, Overseas Decoration Building, #122 Zhenhua RD., Futian, Shenzhen, China





DATA SHEET

SKY65385-11: 791 to 821 MHz Variable Gain Amplifier

Applications

- WCDMA base stations
- Femto cells

Features

- Frequency range: 791 to 821 MHz
- High gain: > 34 dB
- Attenuation range: > 30 dB
- OP1dB: > +30 dBm
- ACLR < -65 dBc for P_{OUT} = +12 dBm
- Single DC supply: +5 V
- Small MCM (12-pin, 8.385 x 8.385 mm) SMT package (MSL3, 260 °C per JEDEC J-STD-020)



Skyworks Pb-free products are compliant with all applicable legislation. For additional information, refer to *Skyworks Definition of Lead (Pb)-Free*, document number SQ04-0073.

Description

Skyworks SKY65385-11 is a high linearity, Variable Gain Amplifier (VGA) module. The device includes an input amplifier driver, a Variable Voltage Attenuator (VVA), and an output Power Amplifier (PA). The two amplifiers and voltage attenuator are optimized for superior ACLR performance with WCDMA signals.

The high linearity (high OP1dB, OIP3, and ACLR) and high efficiency of this device make it ideal for use at the final stage (or close to the final stage) of a WCDMA transmit chain.

The output of the first PA (PA1) is matched to the input of the VVA. The output of the VVA is matched to the input of the second PA (PA2). The RF_IN and RF_OUT signals (pins 1 and 8, respectively) are both internally matched, including DC blocking capacitors.

The SKY65385-11 VGA uses low-cost Surface Mount Technology (SMT) in the form of a compact, 8 x 8 mm 12-pin Multi-Chip Module (MCM), which allows for a highly manufacturable low-cost solution. A functional block diagram is shown in Figure 1. The pin configuration and package are shown in Figure 2. Signal pin assignments and functional pin descriptions are provided in Table 1.

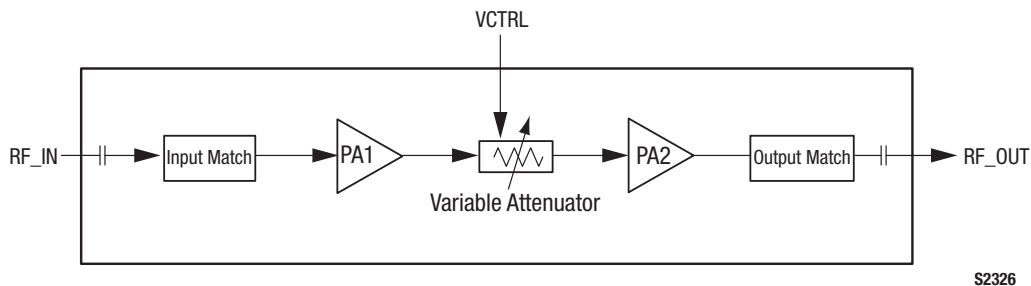

Figure 1. SKY65385-11 Block Diagram

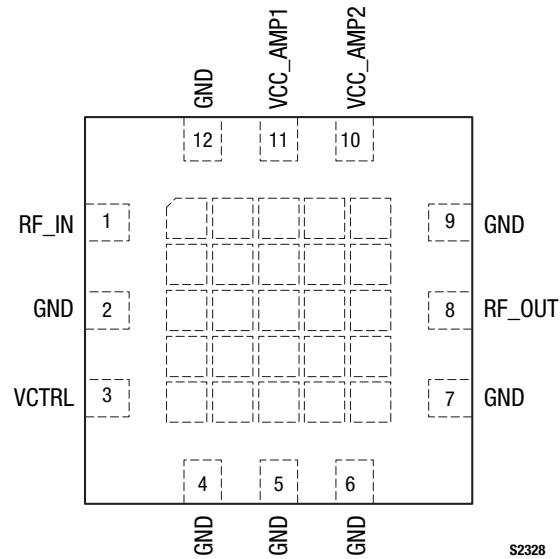

Figure 2. SKY65385-11 Pinout – 12-Pin MCM (Top View)

Table 1. SKY65385-11 Signal Descriptions

Pin	Name	Description	Pin	Name	Description
1	RF_IN	RF input	7	GND	Ground
2	GND	Ground	8	RF_OUT	RF output
3	VCTRL	Variable attenuator control voltage	9	GND	Ground
4	GND	Ground	10	VCC_AMP2	Voltage supply for PA2 (after the variable voltage attenuator)
5	GND	Ground	11	VCC_AMP1	Voltage supply for PA1 (before the variable voltage attenuator)
6	GND	Ground	12	GND	Ground

Electrical and Mechanical Specifications

The absolute maximum ratings of the SKY65385-11 are provided in Table 2. The recommended operating conditions are specified in Table 3 and electrical specifications are provided in Table 4.

Typical performance characteristics of the SKY65385-11 are illustrated in Figures 3 to 12.

Table 2. SKY65385-11 Absolute Maximum Ratings

Parameter	Symbol	Minimum	Maximum	Units
Supply voltage	VCC_AMP1, VCC_AMP2		5.5	V
Control voltage	V _{CTL}		5.0	V
RF output power (CW)	P _{OUT}		+29	dBm
Operating case temperature	T _C	-40	+85	°C
Storage case temperature	T _{STG}	-55	+125	°C
Junction temperature	T _J		+150	°C
Thermal resistance (P _{OUT} = +12 dBm)	θ _R		24	C/W
Electrostatic discharge:	ESD			
Charged Device Model (CDM), Class 3			500	V
Human Body Model (HBM), Class 1B			500	V
Machine Model (MM), Class A			50	V

Note: Exposure to maximum rating conditions for extended periods may reduce device reliability. There is no damage to device with only one parameter set at the limit and all other parameters set at or below their nominal value.

CAUTION: Although this device is designed to be as robust as possible, Electrostatic Discharge (ESD) can damage this device. This device must be protected at all times from ESD. Static charges may easily produce potentials of several kilovolts on the human body or equipment, which can discharge without detection. Industry-standard ESD precautions should be used at all times.

Table 3. SKY65385-11 Recommended Operating Conditions

Parameter	Symbol	Minimum	Typical	Maximum	Units
Frequency range	f	791		821	MHz
RF output power (CW)	P _{OUT}			+12	dBm
Supply voltage, measured at terminals of Evaluation Board	VCC_AMP1, VCC_AMP2	4.75	5.00	5.25	V
Variable voltage attenuator control range	VCTRL	0		3.3	V
Ruggedness, load VSWR with no permanent damage	P _{MAX_LOAD}			8:1	
Operating case temperature	T _C	-40		+85	°C

Table 4. SKY65385-11 Electrical Specifications (Note 1)
(VCC_AMP1 = VCC_AMP2 = 5 V, VCTRL = 0 V, f = 805 MHz, Tc = +25 °C, Characteristic Impedance [Zo] = 50 Ω, Unless Otherwise Noted)

Parameter	Symbol	Test Condition	Min	Typical	Max	Units
Frequency range	f		791		821	MHz
Small signal gain	S21	CW	30.0	34.5		dB
Gain control range	G_RANGE	CW	28	33		dB
Output 1dB Compression Point	OP1dB	CW	+30	+31		dBm
3 rd Order Output Intercept Point	OIP3	P _{TONE} = +12 dBm, Δf = 1 MHz	+42	+46		dBm
ACLR for P _{OUT} = +12 dBm	ACLR	WCDMA, test mode 1		-70	-65.0	dBc
Noise Figure	NF	At maximum gain		4.2	5.0	dB
Input return loss	S11	P _{IN} = -20 dBm	10	14		dB
Output return loss	S22	P _{IN} = -20 dBm	10	12		dB
Quiescent current	I _Q	No RF		460	510	mA
Operating current	I _{OP}	P _{OUT} = +12 dBm		460	510	mA
Maximum VSWR for stable operation	VSWR_MAX	CW	8:1			-

Note 1: Performance is guaranteed only under the conditions listed in this Table.

Typical Performance Characteristics

(VCC_AMP1 = VCC_AMP2 = 5 V, VCTRL = 0 V, f = 805 MHz, Tc = +25 °C, Characteristic Impedance [Zo] = 50 Ω, Unless Otherwise Noted)

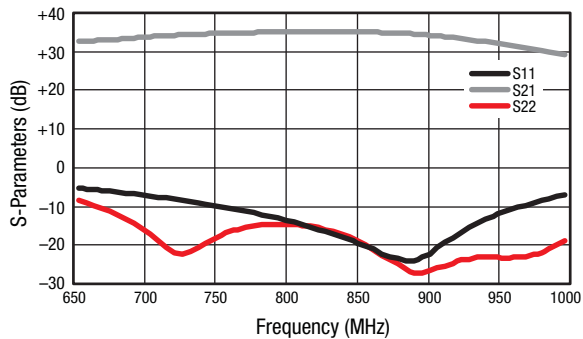

Figure 3. Small Signal Parameters vs Frequency

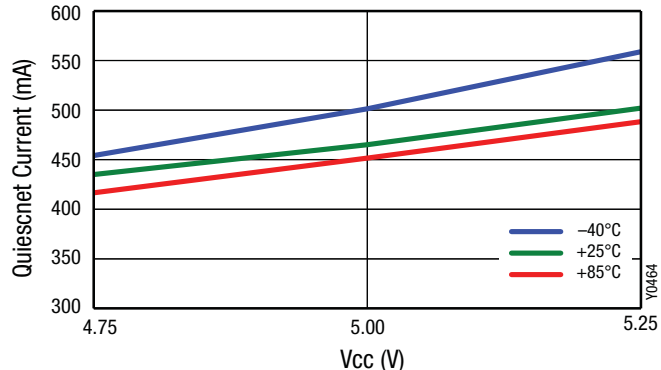

Figure 4. Quiescent Current vs Voltage over Temperature

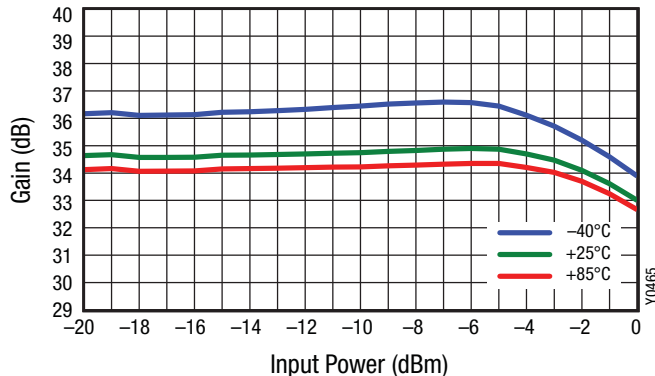

Figure 5. Gain vs Input Power over Temperature

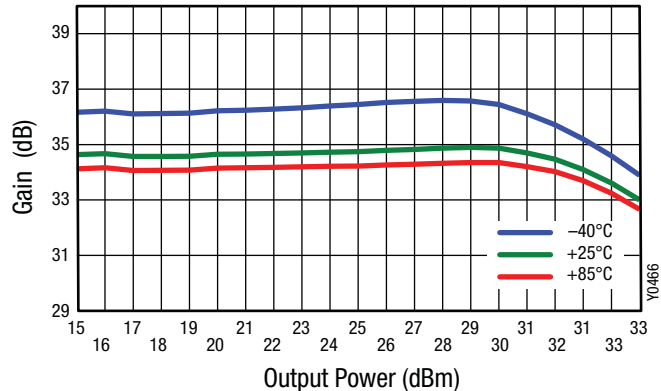

Figure 6. Gain vs Output Power over Temperature

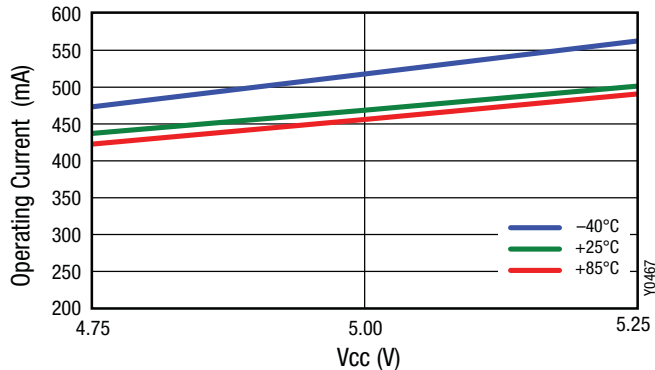

Figure 7. Operating Current vs VCC over Temperature

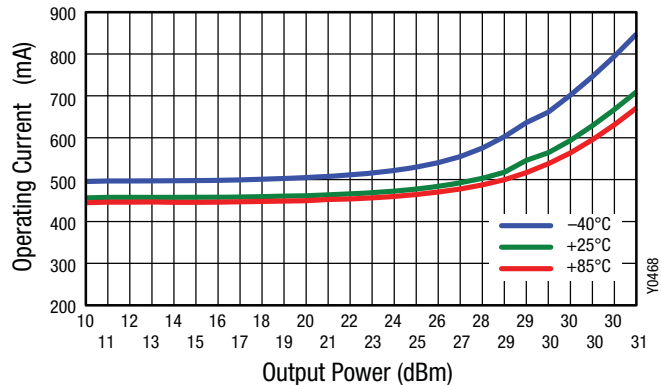

Figure 8. OIP3 vs Output Power

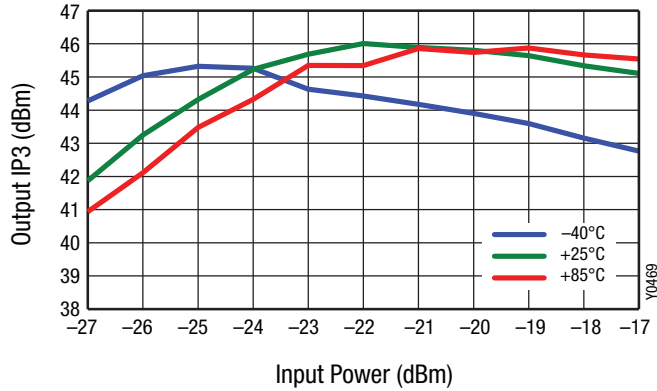

Figure 9. Output IP3 vs Input Power over Temperature

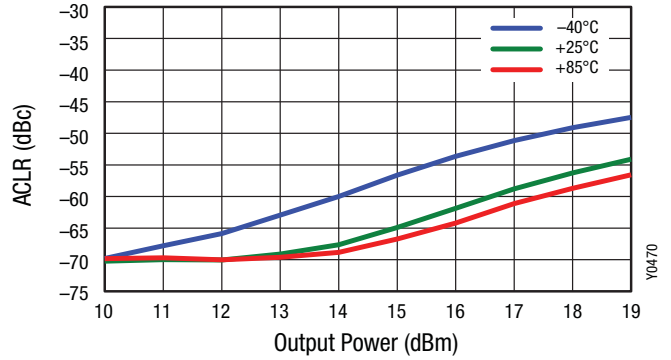

Figure 10. ACLR vs Output Power (WCDMA, TM1)

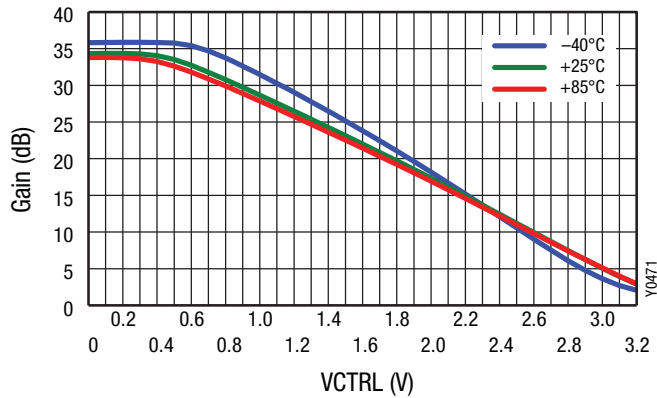

Figure 11. Gain vs VCTRL over Temperature

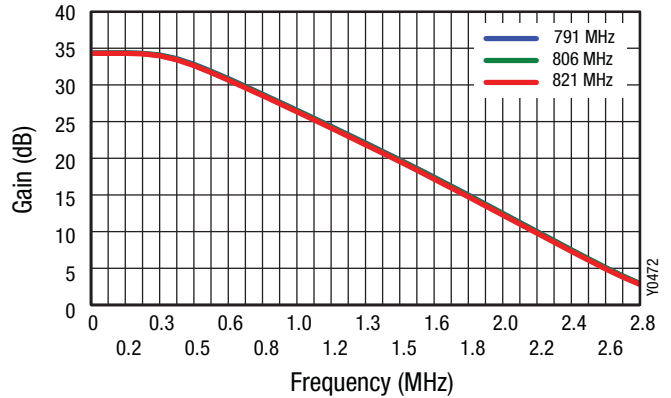

Figure 12. Gain vs VCTRL over Frequency

Evaluation Board Description

The Skyworks SKY65385-11 Evaluation Board is used to test the performance of the SKY65385-11 VGA. An Evaluation Board schematic diagram is provided in Figure 13. An assembly drawing for the Evaluation Board is shown in Figure 14 and the layer detail is provided in Figure 15. The layer detail physical characteristics are noted in Figure 16.

Capacitors C1, C2, and C3 provide DC bias decoupling and RF bypass for VCC_AMP1 (pin 11). Capacitors C4, C5, and C6 provide DC bias decoupling and RF bypass for VCC_AMP2 (pin 10). Capacitor C7 provides decoupling for VCTRL (pin 3).

Pins 1 and 8 are the RF input and output signals, respectively. Pins 2, 4, 5, 6, 7, 9, 12, and the package backside metal are ground pins that provide the DC, RF, and thermal ground.

Circuit Design Configurations

The following design considerations are general in nature and must be followed regardless of final use or configuration:

- Proper isolation must be provided between the VCC_AMP1 and VCC_AMP2 pins.
- Paths to ground should be made as short as possible.
- The ground pad of the SKY65385-11 VGA has special electrical and thermal grounding requirements. This pad is the main thermal conduit for heat dissipation. Since the circuit board acts as the heat sink, it must shunt as much heat as possible from the amplifier. As such, design the connection to the ground pad to dissipate the maximum wattage produced to the circuit board. Multiple vias to the grounding layer are required. Filled or capped vias are recommended.
- It is recommended that the layout for the VCC_AMP1 and VCC_AMP2 signals follow what is shown in Figure 14. The VCC_AMP1 and VCC_AMP2 traces can be tied together to share the same power supply. The connecting node should not be placed close to the package pins. The connecting node should be connected closer to components C1 and C4 (see Figure 13) to provide isolation between VCC_AMP1 and VCC_AMP2.

NOTE: Junction temperature (T_j) of the device increases with a poor connection to the ground pad and ground. This reduces the life of the device.

Testing Procedure

Use the following procedure to set up the SKY65385-11 Evaluation Board for testing:

1. Connect a 5.0 V supply to the VCC_AMP1 and VCC_AMP2 pins. Connect the VCTRL signal to a power supply and set the power supply to 0 V. If available, enable the current limiting function of the power supply to 550 mA.
2. Connect a signal generator to the RF signal input port. Set it to the desired RF frequency at a power level of -20 dBm or less to the Evaluation Board but do NOT enable the RF signal.
3. Connect a spectrum analyzer to the RF signal output port.
4. Enable the power supply.
5. Enable the RF signal.
6. Take measurements.

CAUTION: If any of the output signals exceed the rated maximum values, the SKY65385-11 Evaluation Board can be permanently damaged.

Package and Handling Information

Since the device package is sensitive to moisture absorption, it is baked and vacuum packed before shipping. Instructions on the shipping container label regarding exposure to moisture after the container seal is broken must be followed. Otherwise, problems related to moisture absorption may occur when the part is subjected to high temperature during solder assembly.

The SKY65385-11 is rated to Moisture Sensitivity Level 3 (MSL3) at 260 °C. It can be used for lead or lead-free soldering. For additional information, refer to the Skyworks Application Note, *PCB Design & SMT Assembly/Rework Guidelines for MCM-L Packages*, document number 101752.

Care must be taken when attaching this product, whether it is done manually or in a production solder reflow environment. Production quantities of this product are shipped in a standard tape and reel format.

Package Dimensions

The PDB footprint drawing for the SKY65385-11 is shown in Figure 17. A typical part marking is shown in Figure 18. Package dimensions for the 12-pin MCM are shown in Figure 19, and tape and reel dimensions are provided in Figure 20.

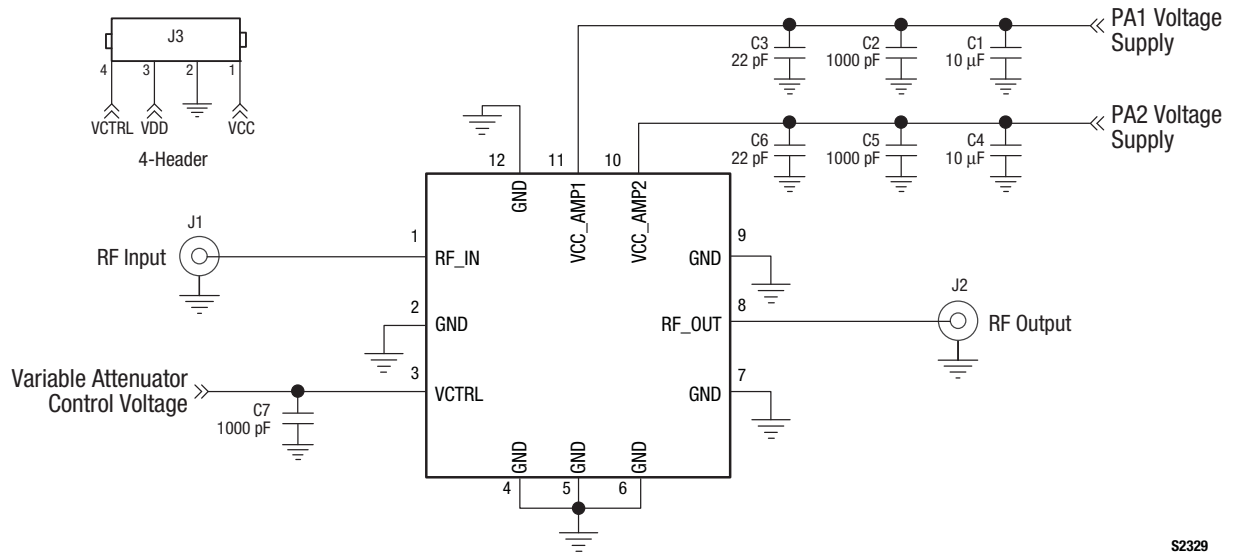

S2329

Figure 13. SKY65385-11 Evaluation Board Schematic

Table 5. SKY385-11 Evaluation Board Bill of Materials (BOM)

Reference Designator	Description	Size
C2, C5, C7	Capacitor, ceramic, 1000 pF, COG (NPO), 50 V, +5%, -5%	0603
C1, C4	Capacitor, ceramic, 1000000 pF, X7R, 10 V, +10%, -10%	0805
C3, C6	5404R71-037 Capacitor, ceramic, 22 pF, 50 V, +5%, -5%	0603

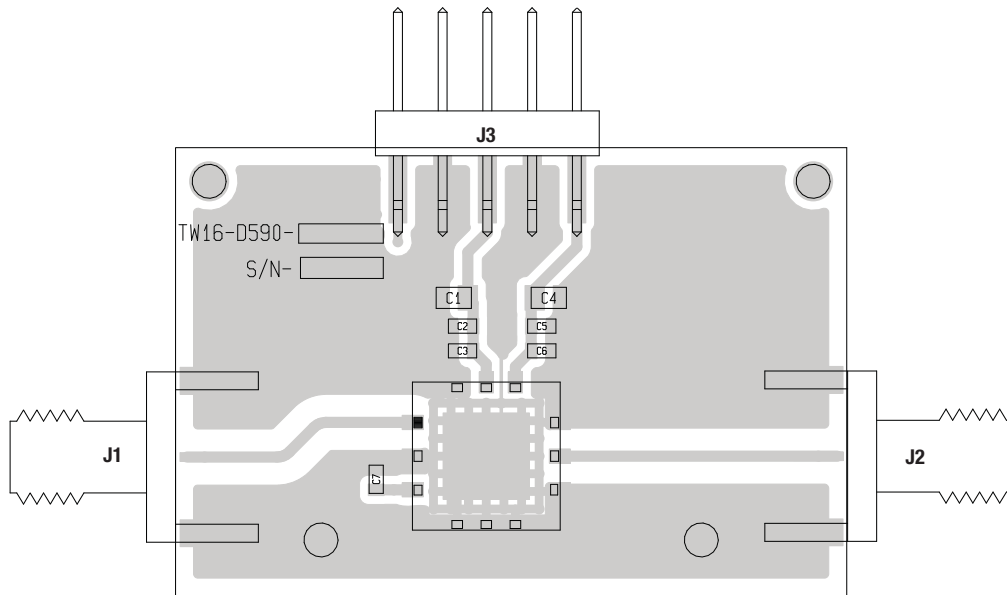

S2330

Figure 14. SKY65385-11 Evaluation Board Assembly Drawing

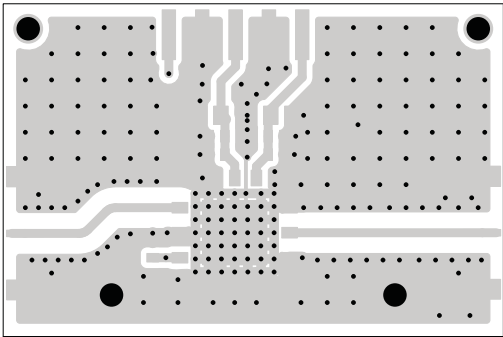

Layer 1: Top – Metal

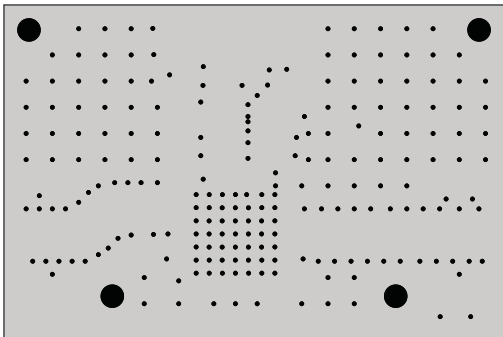

Layer 2: Ground

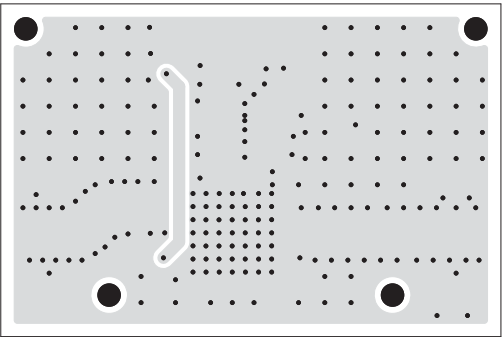

Layer 3: Power Plane

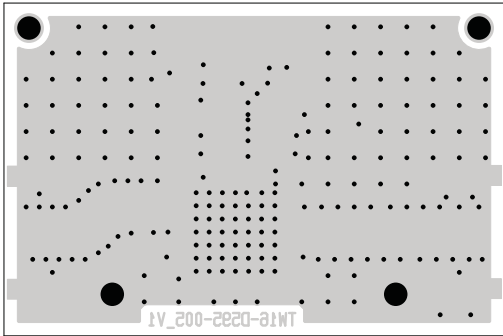

Layer 4: Solid Ground Plane

S2331

Figure 15. SKY65385-11 Evaluation Board Layer Detail

Cross Section	Name	Thickness (mm)	Material	ϵ_r
	Pri	0.035	Cu-1 oz.	-
	Die1	0.250	Rogers 4350	-
	L2	0.035	Cu-1 oz.	-
	Die2	0.200	FR4	4.0
	L3	0.035	Cu-1 oz.	-
	Die3	0.250	FR4	4.0
	Sec	0.035	Cu-1 oz.	-

S2631

Figure 16. Layer Detail Physical Characteristics

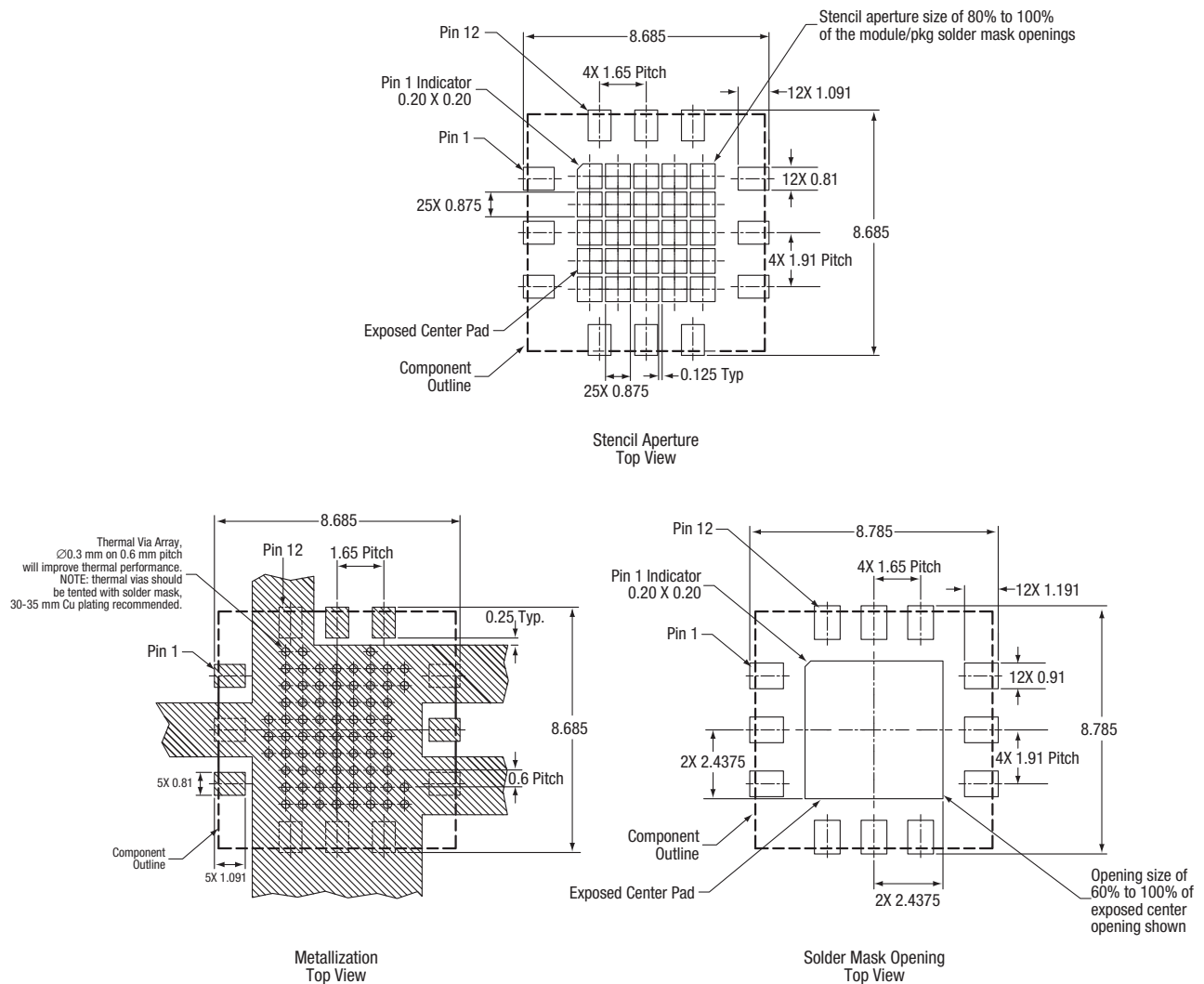

All dimensions are in millimeters

S2367

Figure 17. SKY65385-11 PCB Layout Footprint

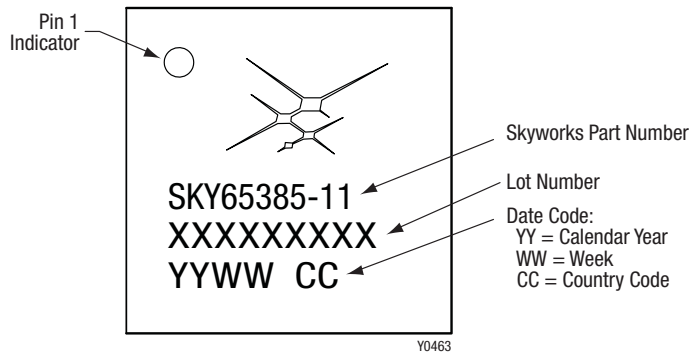
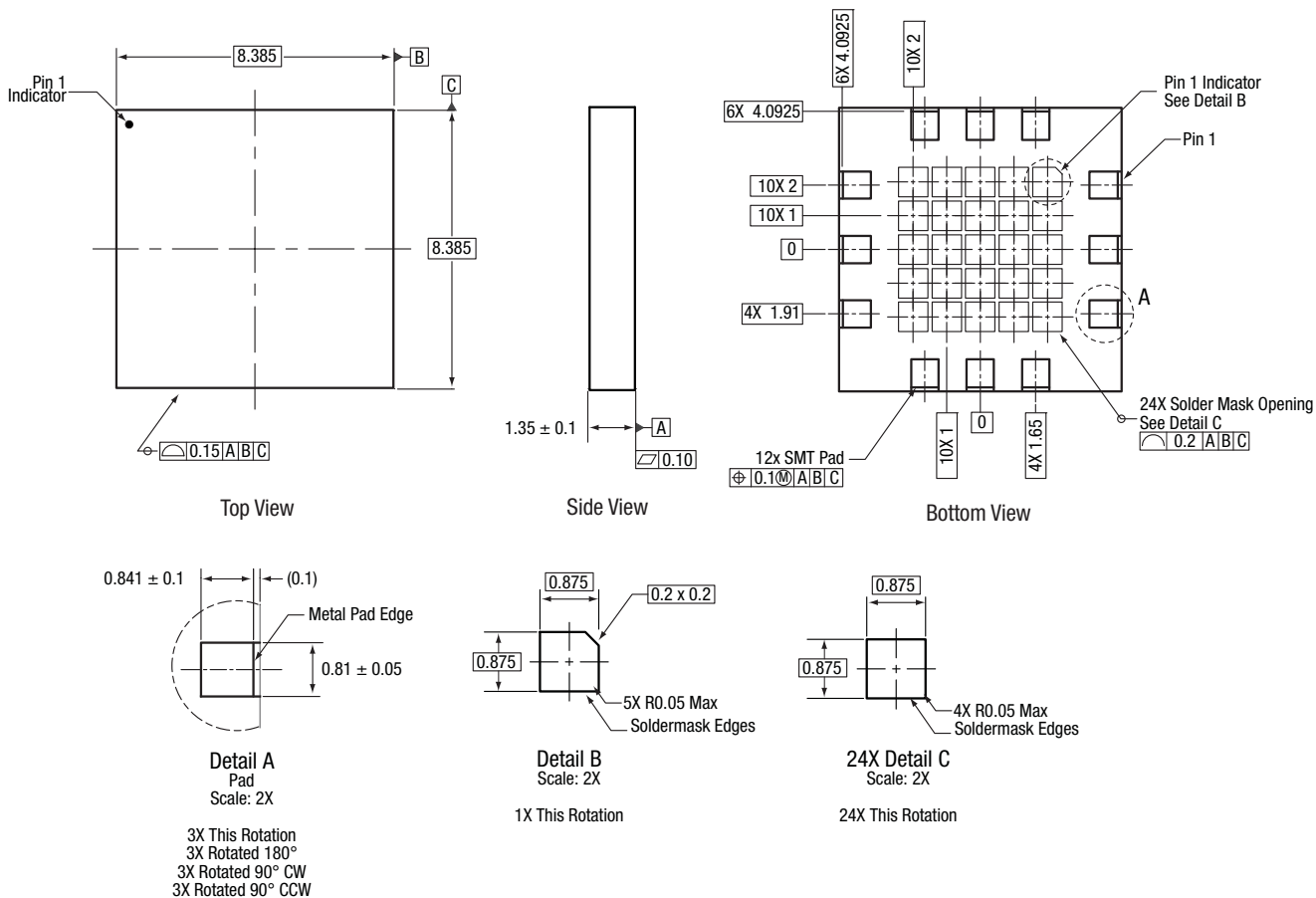

Figure 18. Typical Part Marking



Dimensioning and tolerancing according to ASME Y14.5M-1994.
 Pads are metal defined.
 All measurements are in millimeters

S2366

Figure 19. SKY65385-11 12-Pin MCM Package Dimensions

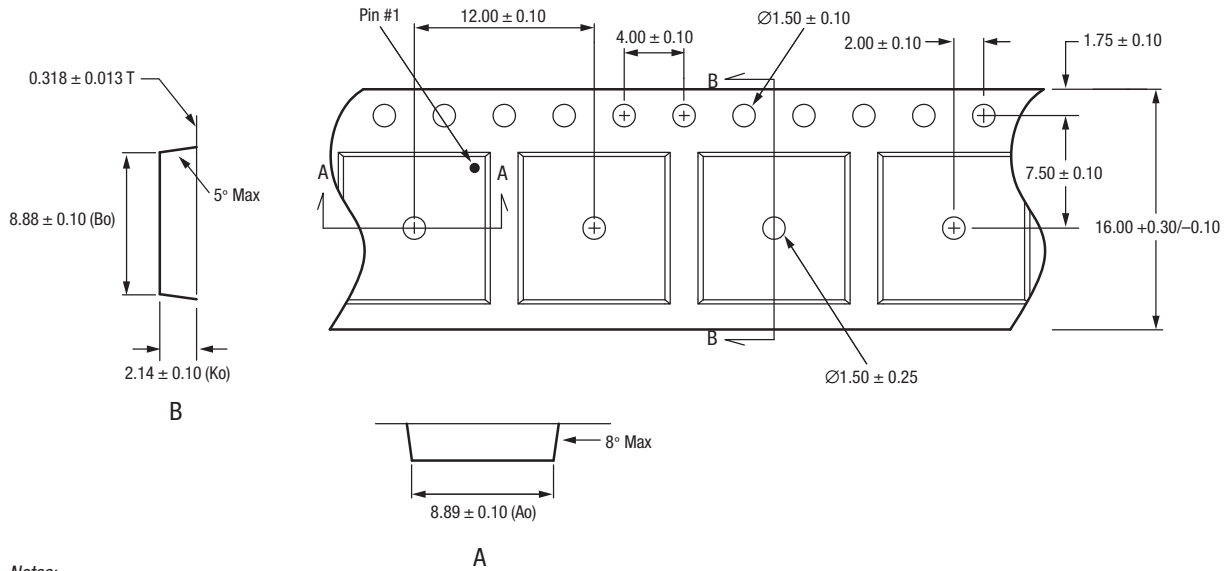

Notes:

1. Carrier tape material: black conductive polycarbonate or polystyrene.
2. Cover tape material: transparent conductive PSA.
3. Cover tape size: 13.3 mm width.
4. Typical ESD surface resistivity is $\leq 10^8$ Ohms/square per EIA, JEDEC tape and reel specification.
5. Tolerance: .XX = ± 0.10 mm.
6. All measurements are in millimeters.

S2630

Figure 20. SKY65385-11 Tape and Reel Dimensions

Ordering Information

Model Name	Manufacturing Part Number	Evaluation Board Part Number
SKY65385-11 791 to 821 MHz Variable Gain Amplifier	SKY65385-11	TW16-D590

Copyright © 2012-2014 Skyworks Solutions, Inc. All Rights Reserved.

Information in this document is provided in connection with Skyworks Solutions, Inc. (“Skyworks”) products or services. These materials, including the information contained herein, are provided by Skyworks as a service to its customers and may be used for informational purposes only by the customer. Skyworks assumes no responsibility for errors or omissions in these materials or the information contained herein. Skyworks may change its documentation, products, services, specifications or product descriptions at any time, without notice. Skyworks makes no commitment to update the materials or information and shall have no responsibility whatsoever for conflicts, incompatibilities, or other difficulties arising from any future changes.

No license, whether express, implied, by estoppel or otherwise, is granted to any intellectual property rights by this document. Skyworks assumes no liability for any materials, products or information provided hereunder, including the sale, distribution, reproduction or use of Skyworks products, information or materials, except as may be provided in Skyworks Terms and Conditions of Sale.

THE MATERIALS, PRODUCTS AND INFORMATION ARE PROVIDED “AS IS” WITHOUT WARRANTY OF ANY KIND, WHETHER EXPRESS, IMPLIED, STATUTORY, OR OTHERWISE, INCLUDING FITNESS FOR A PARTICULAR PURPOSE OR USE, MERCHANTABILITY, PERFORMANCE, QUALITY OR NON-INFRINGEMENT OF ANY INTELLECTUAL PROPERTY RIGHT; ALL SUCH WARRANTIES ARE HEREBY EXPRESSLY DISCLAIMED. SKYWORKS DOES NOT WARRANT THE ACCURACY OR COMPLETENESS OF THE INFORMATION, TEXT, GRAPHICS OR OTHER ITEMS CONTAINED WITHIN THESE MATERIALS. SKYWORKS SHALL NOT BE LIABLE FOR ANY DAMAGES, INCLUDING BUT NOT LIMITED TO ANY SPECIAL, INDIRECT, INCIDENTAL, STATUTORY, OR CONSEQUENTIAL DAMAGES, INCLUDING WITHOUT LIMITATION, LOST REVENUES OR LOST PROFITS THAT MAY RESULT FROM THE USE OF THE MATERIALS OR INFORMATION, WHETHER OR NOT THE RECIPIENT OF MATERIALS HAS BEEN ADVISED OF THE POSSIBILITY OF SUCH DAMAGE.

Skyworks products are not intended for use in medical, lifesaving or life-sustaining applications, or other equipment in which the failure of the Skyworks products could lead to personal injury, death, physical or environmental damage. Skyworks customers using or selling Skyworks products for use in such applications do so at their own risk and agree to fully indemnify Skyworks for any damages resulting from such improper use or sale.

Customers are responsible for their products and applications using Skyworks products, which may deviate from published specifications as a result of design defects, errors, or operation of products outside of published parameters or design specifications. Customers should include design and operating safeguards to minimize these and other risks. Skyworks assumes no liability for applications assistance, customer product design, or damage to any equipment resulting from the use of Skyworks products outside of stated published specifications or parameters.

Skyworks, the Skyworks symbol, and “Breakthrough Simplicity” are trademarks or registered trademarks of Skyworks Solutions, Inc., in the United States and other countries. Third-party brands and names are for identification purposes only, and are the property of their respective owners. Additional information, including relevant terms and conditions, posted at www.skyworksinc.com, are incorporated by reference.