



Chipsmall Limited consists of a professional team with an average of over 10 year of expertise in the distribution of electronic components. Based in Hongkong, we have already established firm and mutual-benefit business relationships with customers from,Europe,America and south Asia,supplying obsolete and hard-to-find components to meet their specific needs.

With the principle of "Quality Parts,Customers Priority,Honest Operation,and Considerate Service",our business mainly focus on the distribution of electronic components. Line cards we deal with include Microchip,ALPS,ROHM,Xilinx,Pulse,ON,Everlight and Freescale. Main products comprise IC,Modules,Potentiometer,IC Socket,Relay,Connector.Our parts cover such applications as commercial,industrial, and automotives areas.

We are looking forward to setting up business relationship with you and hope to provide you with the best service and solution. Let us make a better world for our industry!



Contact us

Tel: +86-755-8981 8866 Fax: +86-755-8427 6832

Email & Skype: info@chipsmall.com Web: www.chipsmall.com

Address: A1208, Overseas Decoration Building, #122 Zhenhua RD., Futian, Shenzhen, China



DATA SHEET

SKY67022-396LF: 1.6 to 2.2 GHz High-Linearity, Active-Bias Low-Noise Amplifier

Applications

- GSM, CDMA, WCDMA, TD-SCDMA cellular infrastructure
- Ultra low-noise systems
- Balanced, single-ended low-noise amplifier designs

Features

- Extended operating temperature range: -40 °C to +100 °C
- Low noise figure: 0.65 dB @ 1.85 GHz
- Excellent IIP3 performance: +21.3 dBm @ 1.85 GHz
- Gain: 17.3 dB @ 1.85 GHz
- Adjustable supply current
- Integrated enable circuitry
- Temperature and process-stable active bias
- Miniature DFN (8-pin, 2 x 2 mm) package (MSL1 @ 260 °C per JEDEC J-STD-020)



Skyworks Green™ products are compliant with all applicable legislation and are halogen-free. For additional information, refer to *Skyworks Definition of Green™*, document number SQ04-0074.

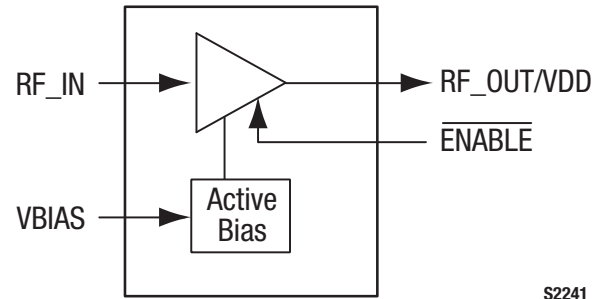

Figure 1. SKY67022-396LF Block Diagram

Description

The SKY67022-396LF is GaAs, pHEMT low-noise amplifier (LNA) with an active bias and high-linearity performance. The advanced GaAs pHEMT enhancement mode process provides good return loss, low noise, and high-linearity performance.

The internal active bias circuitry provides stable performance over temperature and process variation. The device offers the ability to externally adjust supply current and gain. Supply voltage is applied to the RFOUT/VDD pin through an RF choke inductor. Pin 3 (VBIAS) should be connected to RFOUT/VDD through an external resistor to control the supply current. The RFIN and RFOUT/VDD pins should be DC blocked to ensure proper operation.

The SKY67022-396LF operates in the frequency range of 1.6 to 2.2 GHz. For lower and higher frequency operation, the pin-compatible SKY67021-396LF and SKY67023-396LF, respectively, should be used.

The LNA is manufactured in a compact, 2 x 2 mm, 8-pin Dual Flat No-Lead (DFN) package. A functional block diagram is shown in Figure 1. The pin configuration and package are shown in Figure 2. Signal pin assignments and functional pin descriptions are provided in Table 1.

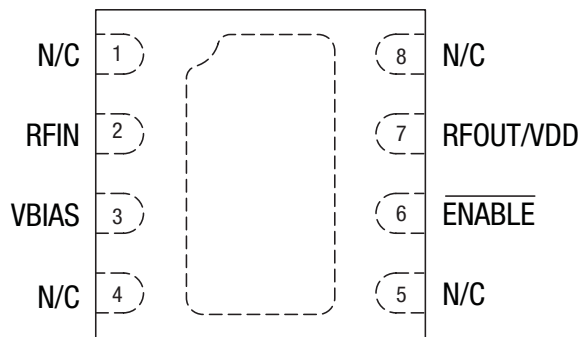

S2240

Figure 2. SKY67022-396LF Pinout (Top View)

Table 1. SKY67022-396LF Signal Descriptions

Pin	Name	Description	Pin	Name	Description
1	N/C	No connection. May be connected to ground with no change in performance.	5	N/C	No connection. May be connected to ground with no change in performance.
2	RFIN	RF input. DC blocking capacitor required.	6	ENABLE	Enable pin. Active “low” (0 V) = amplifier on state.
3	VBIAS	Bias for 1 st stage amplifier. External resistor sets current consumption.	7	RFOUT/VDD	RF output. Apply VDD through RF choke inductor. DC blocking capacitor required.
4	N/C	No connection. May be connected to ground with no change in performance.	8	N/C	No connection. May be connected to ground with no change in performance.

Table 2. SKY67022-396LF Absolute Maximum Ratings¹

Parameter	Symbol	Minimum	Typical	Maximum	Units
Supply voltage	V _{DD}		5.0	5.5	V
Supply current	I _{DD}			150	mA
RF input power	P _{IN}			+20	dBm
Channel temperature	T _{CH}			+150	°C
Thermal resistance ²	Θ _{JC}		70		°C/W
Storage temperature	T _{STG}	-65	+25	+150	°C
Operating temperature	T _A	-55	+25	+100	°C
Electrostatic discharge:	ESD				
Charged Device Model (CDM), Class 4		1000			V
Human Body Model (HBM), Class 1A		250			V
Machine Model (MM), Class A		25			V

¹ Exposure to maximum rating conditions for extended periods may reduce device reliability. There is no damage to device with only one parameter set at the limit and all other parameters set at or below their nominal value. Exceeding any of the limits listed here may result in permanent damage to the device.

² Thermal resistance = 70 °C/W @ 5 V bias.

ESD HANDLING: *Although this device is designed to be as robust as possible, electrostatic discharge (ESD) can damage this device. This device must be protected at all times from ESD when handling or transporting. Static charges may easily produce potentials of several kilovolts on the human body or equipment, which can discharge without detection. Industry-standard ESD handling precautions should be used at all times.*

Electrical and Mechanical Specifications

The absolute maximum ratings of the SKY67022-396LF are provided in Table 2. Electrical specifications are provided in Table 3.

Typical performance characteristics of the SKY67022-396LF are illustrated in Figures 3 through 20.

Table 4 provides noise source pull information versus frequency.

Table 3. SKY67022-396LF Electrical Specifications^{1,2}**(V_{DD} = 5 V, I_{DD} = 95 mA, T_A = +25 °C, P_{IN} = -20 dBm, Characteristic Impedance [Z₀] = 50 Ω, Unless Otherwise Noted)**

Parameter	Symbol	Test Condition	Min	Typical	Max	Units
RF Specifications						
Noise figure ³	NF	@ 1.85 GHz		0.65	0.85	dB
Small signal gain	IS21I	@ 1.85 GHz	16.5	17.5	18.5	dB
Input return loss	IS11I	@ 1.85 GHz	15	20		dB
Output return loss	IS22I	@ 1.85 GHz	11	16		dB
Reverse isolation	IS12I	@ 1.85 GHz	27	31		dB
Third order input intercept point	IIP3	@ 1.85 GHz, Δf = 1 MHz, P _{IN} = -20 dBm/tone	+19.5	+22.0		dBm
Third order output intercept point	OIP3	@ 1.85 GHz, Δf = 1 MHz, P _{IN} = -20 dBm/tone	+37.0	+39.5		dBm
1 dB input compression point	IP1dB	@ 1.85 GHz	+3.5	+5.5		dBm
1 dB output compression point	OP1dB	@ 1.85 GHz	+20	+22		dBm
Stability ⁴	μ, μ1	Up to 18 GHz, -40 °C to +85 °C		> 1		-
DC Specifications						
Supply voltage	V _{DD}			5.0		V
Quiescent supply current	I _{DD}	Set with external resistor	80	95	110	mA
Amplifier enable off current (logic "high")	I _{EN}			900	1000	μA
Enable voltage:	V _{ENABLE}					
Gain mode				0	0.2	V
Power-down mode				1.5	5.5	V
Enable rise time	T _R	@ 1.85 GHz		250	500	ns
Enable fall time	T _F	@ 1.85 GHz		250	500	ns

¹ Performance is guaranteed only under the conditions listed in this table.² Circuit topology optimized for balanced configuration with best IIP3 and NF performance.³ Loss from the input SMA connector and Evaluation Board up to component M1 has been de-embedded from the NF measurement (0.06 dB).⁴ Applies to typical application circuit and components shown in Figure 25.

Typical Performance Characteristics

(VDD = 5 V, IDD = 95 mA, TA = +25 °C, PIN = -20 dBm, Characteristic Impedance [Zo] = 50 Ω, Unless Otherwise Noted)

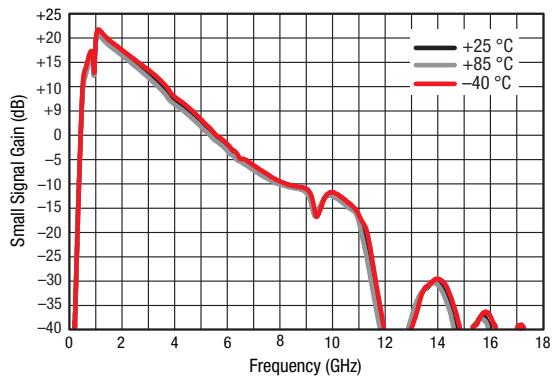

Figure 3. Broadband Gain Response vs Frequency Over Temperature

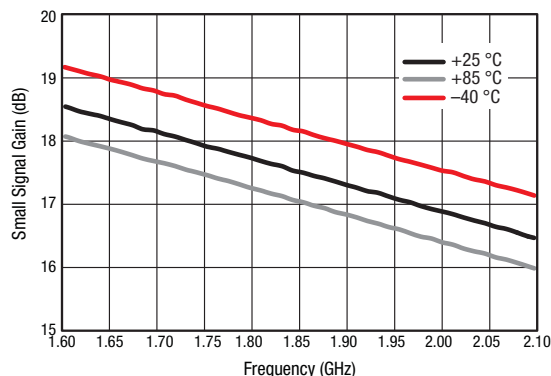

Figure 4. Narrowband Gain Response vs Frequency Over Temperature

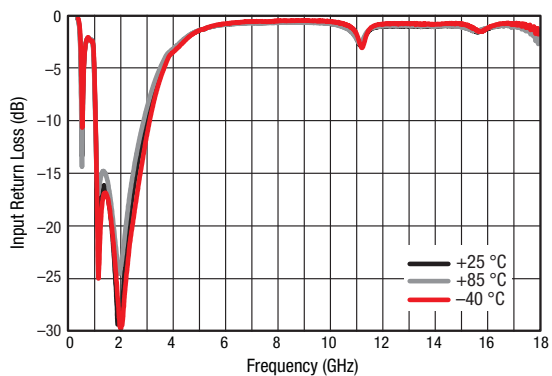

Figure 5. Broadband Input Return Loss vs Frequency Over Temperature

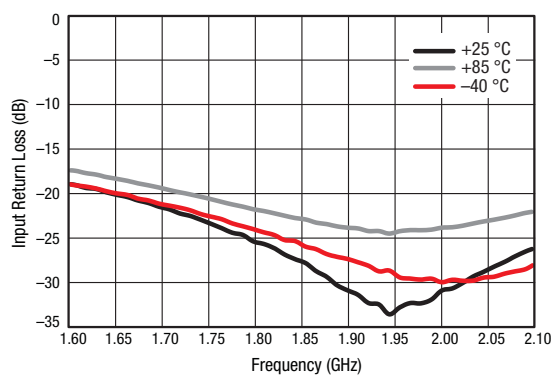

Figure 6. Narrowband Input Return Loss vs Frequency Over Temperature

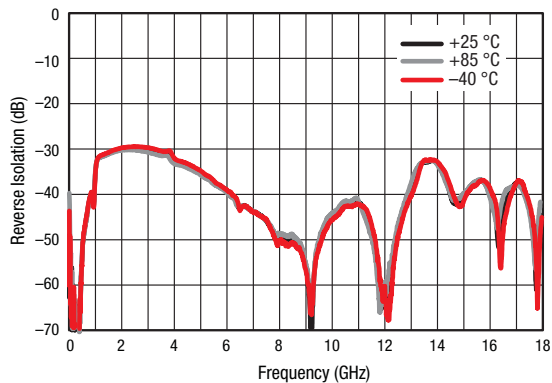

Figure 7. Broadband Reverse Isolation vs Frequency Over Temperature

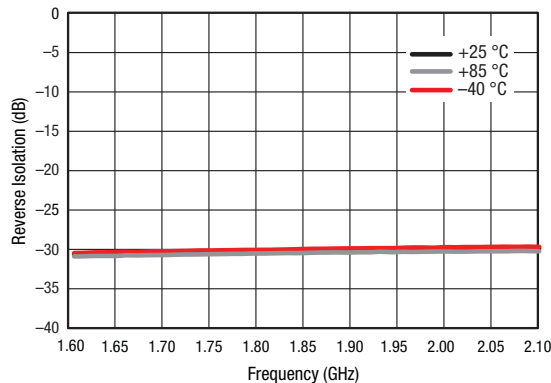

Figure 8. Narrowband Reverse Isolation vs Frequency Over Temperature

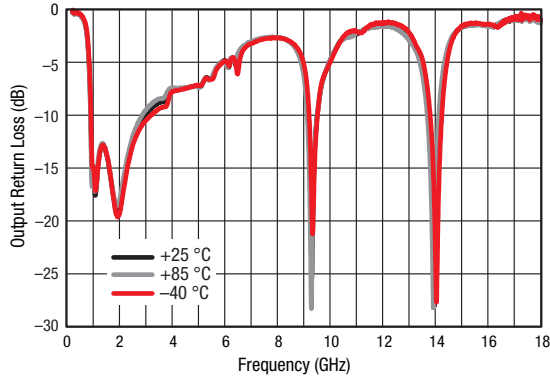

Figure 9. Broadband Output Return Loss vs Frequency Over Temperature

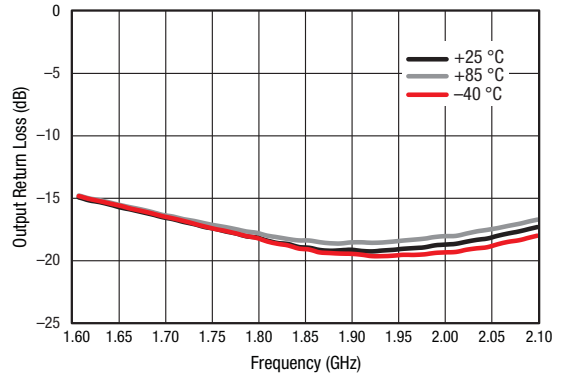

Figure 10. Narrowband Output Return Loss vs Frequency Over Temperature

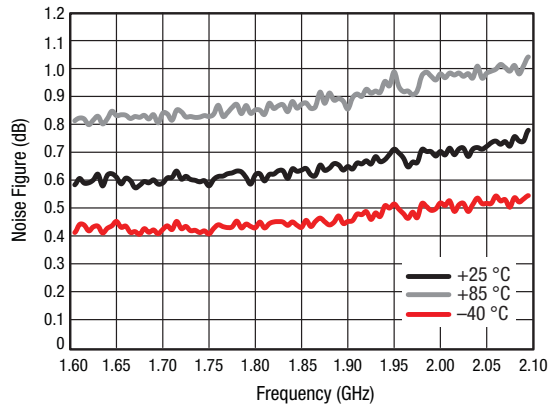

Figure 11. Noise Figure vs Frequency Over Temperature

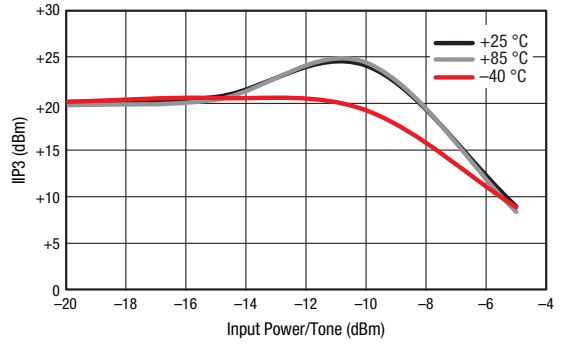

Figure 12. IIP3 vs Input Power Over Temperature @ 5 V, 1700 MHz (Tone Spacing = 1 MHz)

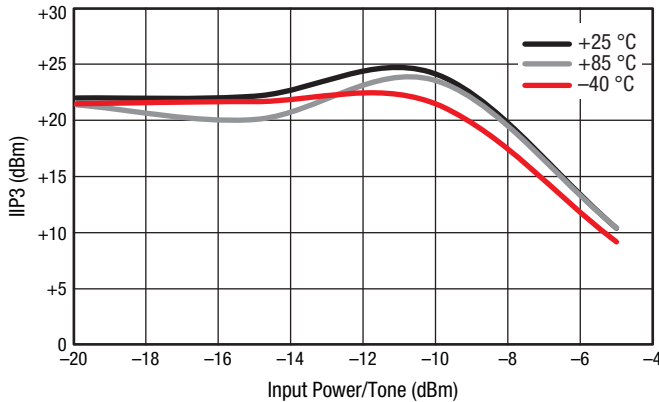

Figure 13. IIP3 vs Input Power Over Temperature @ 5 V, 1850 MHz (Tone Spacing = 1 MHz)

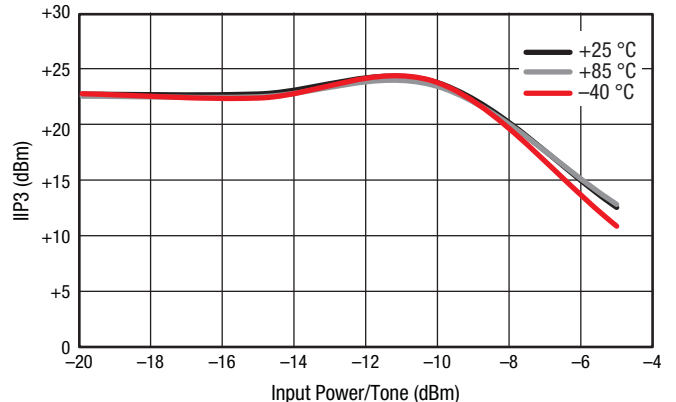

Figure 14. IIP3 vs Input Power Over Temperature @ 5 V, 2000 MHz (Tone Spacing = 1 MHz)

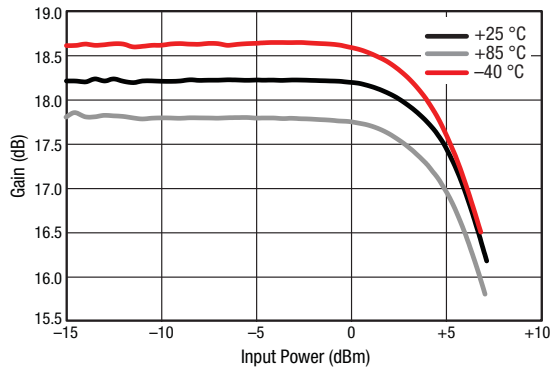

Figure 15. Gain vs Input Power Over Temperature @ 5 V, 1700 MHz

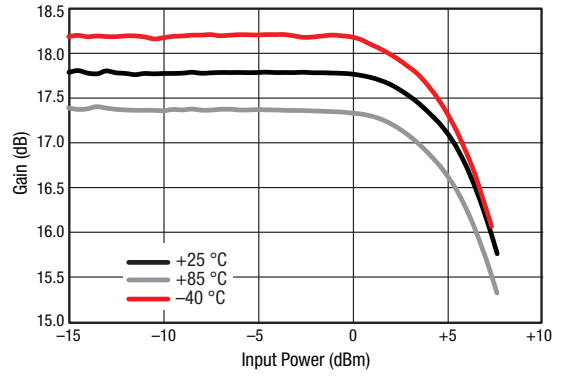

Figure 16. Gain vs Input Power Over Temperature @ 5 V, 1850 MHz

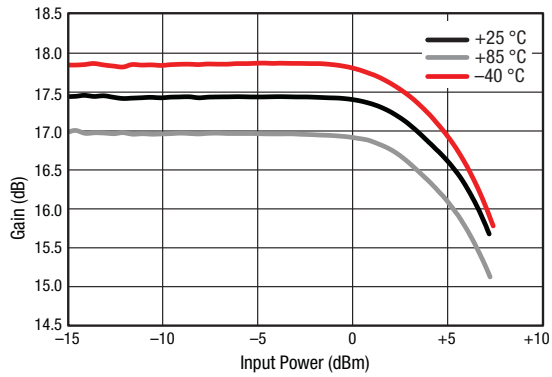

Figure 17. Gain vs Input Power Over Temperature @ 5.0 V, 2000 MHz

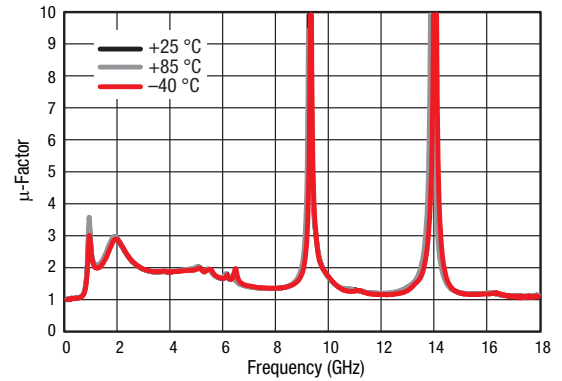

Figure 18. Stability Factor (μ) vs Frequency Over Temperature @ 5 V

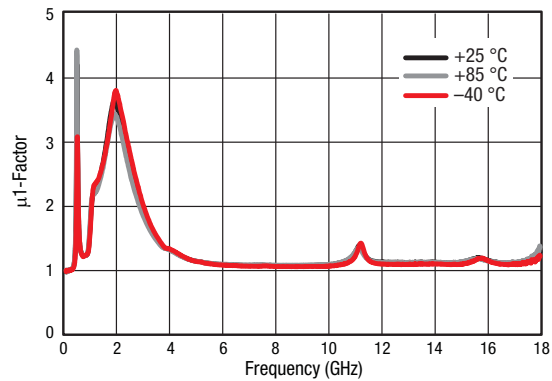

Figure 19. Stability Factor (μ_1) vs Frequency Over Temperature @ 5 V

Swept F1 Load Gamma Pull
 Freq = 1.8000 GHz
 ΓSource: 0.3731< 153.65

Gt max = 18.53 dB
 at 0.3874< 170.44
 5 contours, 1.00 dB step
 (14.00 to 18.00 dB)

Ip3 max = 42.04 dBm
 at 0.2655< -70.41
 5 contours, 0.50 dBm step
 (40.00 to 42.00 dBm)

Specs: OFF

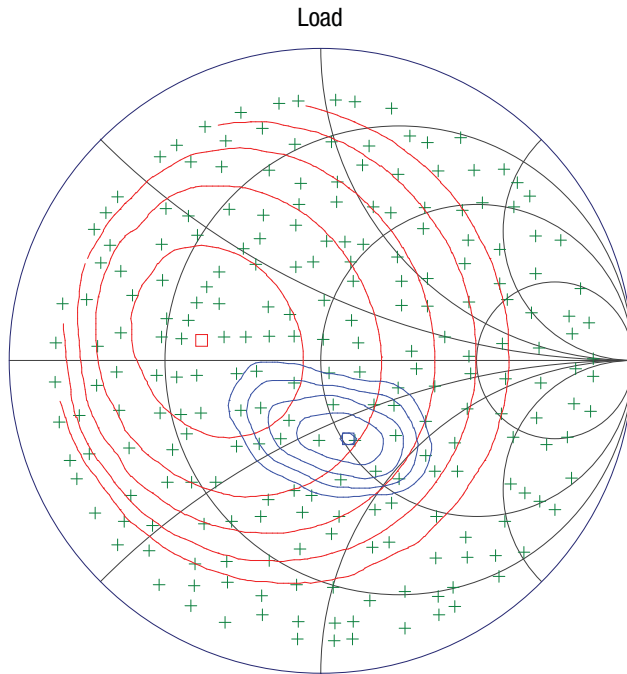

Label:
 OIP3_SKY67022_1800MHz_5V_95mA

Figure 20. Load Pull, @ 5 V and 95 mA

Table 4. Noise Parameters vs Frequency (5 V, 95 mA)

Frequency (GHz)	Minimum Noise Figure (F _{MIN}) (dB)	Noise Resistance (R _N) (Ω)	Γ _{opt}		Associated Gain (dB)	Maximum Gain (G _{MAX}) (dB)
			Magnitude	Phase		
0.80	0.3943	0.0568	0.2238	87.63	24.5523	25.2847
0.84	0.4094	0.0471	0.2306	92.18	24.1907	24.8043
0.89	0.3536	0.0471	0.2612	96.64	23.7780	24.2572
1.20	0.4557	0.0492	0.2812	109.80	21.3562	21.5950
1.42	0.4733	0.0372	0.3975	129.07	20.0944	20.1705
1.52	0.5374	0.0445	0.3073	133.12	19.5423	19.6000
1.76	0.6205	0.0379	0.3401	148.53	18.3915	18.3948
1.84	0.6403	0.0360	0.3616	156.51	18.0381	18.0424
1.92	0.6477	0.0336	0.3760	158.03	17.6947	17.7022
1.98	0.7190	0.0339	0.3614	159.47	17.4468	17.4548
2.00	0.7497	0.0398	0.3744	161.91	17.3564	17.3731
2.38	0.8417	0.0321	0.4238	174.63	15.8965	15.9979
2.48	0.8800	0.0340	0.4230	179.22	15.541	15.6796
2.52	0.9242	0.0332	0.4217	-176.79	15.3704	15.5535
2.60	0.9003	0.0368	0.4334	-179.03	15.1584	15.3139
3.00	1.0519	0.0413	0.5207	-153.49	13.4396	14.2395

Evaluation Board Description

The SKY67022-396LF Evaluation Board is used to test the performance of the SKY67022-396LF LNA. An assembly drawing for the Evaluation Board is shown in Figure 21. The layer detail is provided in Figure 22. An Evaluation Board schematic diagram is provided in Figure 23. Table 5 provides the Bill of Materials (BOM) list for Evaluation Board components.

Package Dimensions

The PCB layout footprint for the SKY67022-396LF is provided in Figure 24. Typical part markings are shown in Figure 25. Package dimensions are shown in Figure 26, and tape and reel dimensions are provided in Figure 27.

Package and Handling Information

Instructions on the shipping container label regarding exposure to moisture after the container seal is broken must be followed. Otherwise, problems related to moisture absorption may occur when the part is subjected to high temperature during solder assembly.

The SKY67022-396LF is rated to Moisture Sensitivity Level 1 (MSL1) at 260 °C. It can be used for lead or lead-free soldering. For additional information, refer to the Skyworks Application Note, *Solder Reflow Information*, document number 200164.

Care must be taken when attaching this product, whether it is done manually or in a production solder reflow environment. Production quantities of this product are shipped in a standard tape and reel format.

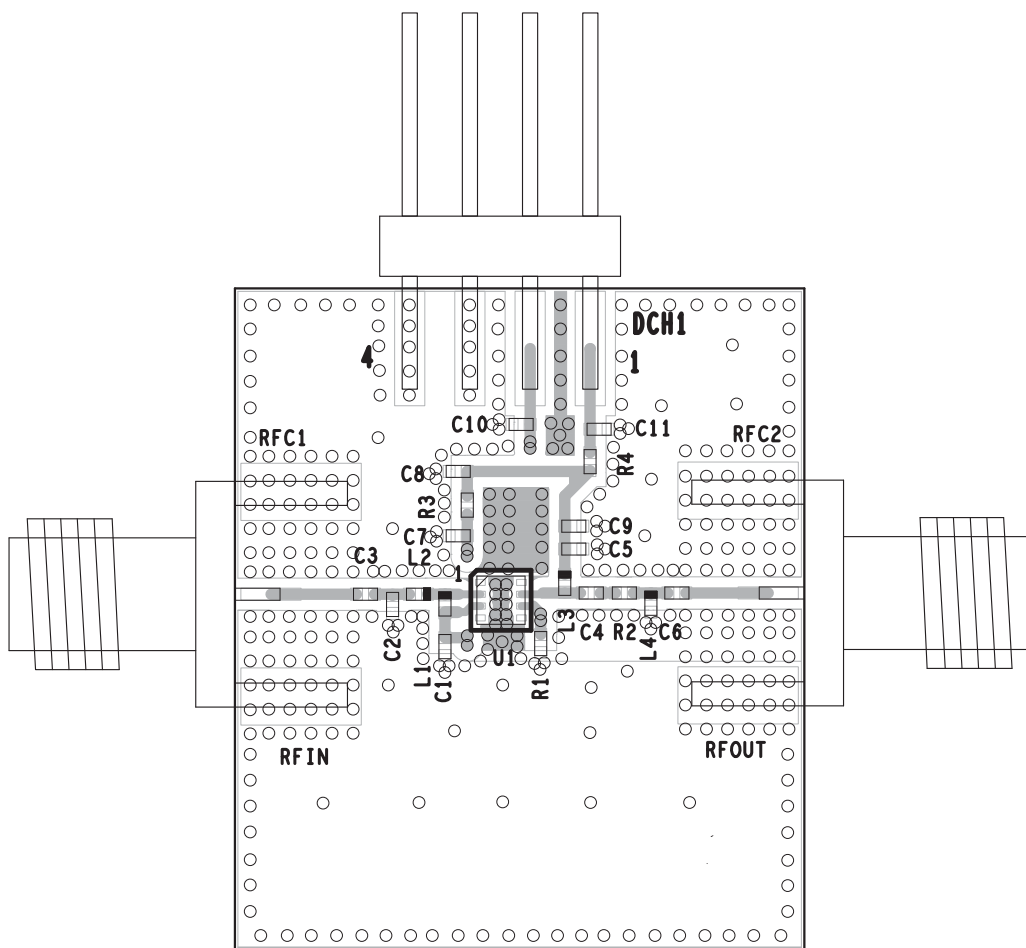
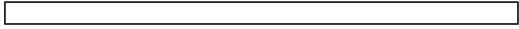
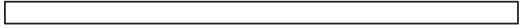

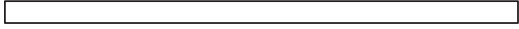



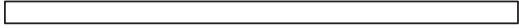



Figure 21. SKY67022-396LF Evaluation Board Assembly Diagram

Cross Section	Name	Thickness (mm)	Material
	MSK-NS		
	TRA-NS	0.03556	Cu foil
	Laminate	0.254 ± 0.152	Rogers 4350B
	TRA-2	0.178	Cu foil
	Laminate	0.889 nom.	FR4 Prepreg (Note 1)
	TRA-3	0.0178	Cu foil
	Laminate	0.254 ± 0.152	FR4 Core
	TRA-FS	0.0178	Cu foil
	MSK-PS		

Note 1: Adjust this thickness to meet total thickness goal.

General Notes:
 Material: Rogers R04350, $\epsilon_r = 3.66$
 Layer 1 thickness: 0.254 mm
 Overall board thickness: 1.575 mm
 50 Ω transmission line width: 0.522 mm
 Coplanar ground spacing: 1.575 mm
 Via diameter: 0.254 mm

S2574

Figure 22. Layer Detail Physical Characteristics

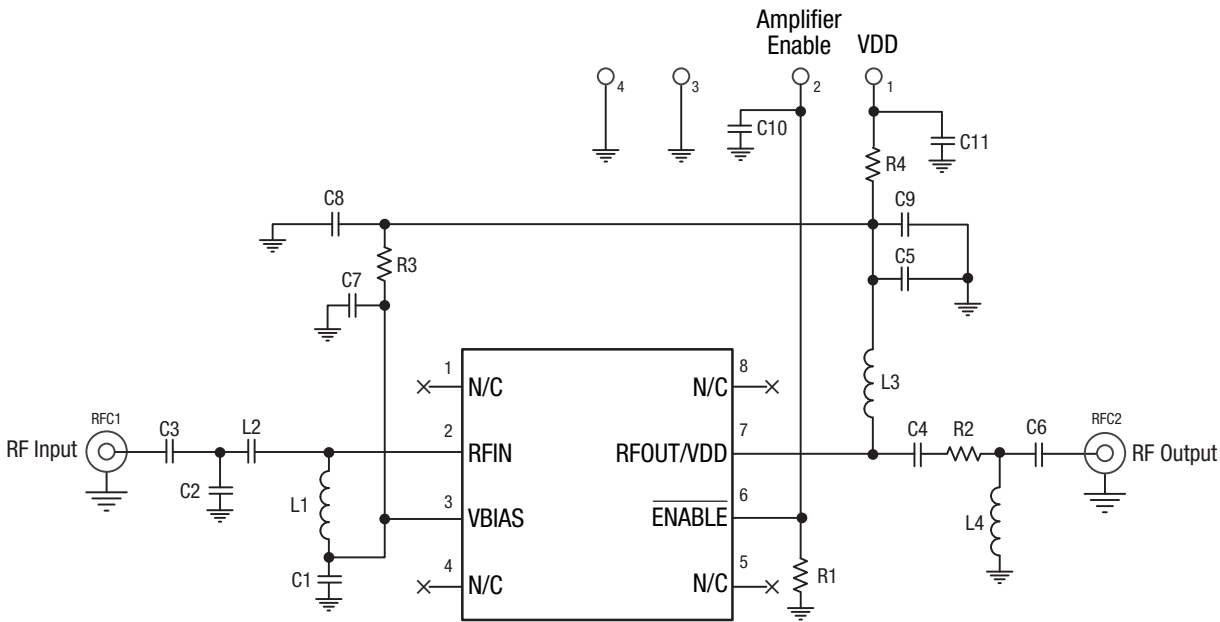

Note: Remove R1 if Enable function is desired.
This circuit configured for "Amplifier On."

S2254

Figure 23. SKY67022-396LF Evaluation Board Schematic

Table 5. SKY67022-396LF Evaluation Board Bill of Materials (Optimized for 1.7 to 2.0 GHz)

Component	Size	Value (5 V @ 95 mA)	Value for Improved IIP3 (4 V @ 95 mA)	Manufacturer	Mfr Part Number
C1	0402	12 pF	12 pF	Murata	GJM1555C1H120JB01
C2	0402	0.5 pF	0.5 pF	Murata	GJM1555C1HR50BB01
C3	0402	3.6 pF	3.6 pF	Murata	GJM1555C1H3R6CB01
C4	0402	2.2 pF	2.2 pF	Murata	GRM1555C1H2R2CZ01
C5, C7, C8, C10, C11	0402	1000 pF	1000 pF	Murata	GRM1555C1H102JA01
C6	0402	100 pF	100 pF	Murata	GRM1555C1H101JZ01
C9	0402	DNI	DNI	–	–
L1	0402	6.8 nH	6.8 nH	Coilcraft HP	0402HP-6N8X_L
L2	0402	2.4 nH	2.4 nH	Coilcraft HP	0402HP-2N4X_L
L3	0402	4.7 nH	4.7 nH	TDK	MLG1005S4N7S
L4	0402	6.8 nH	6.8 nH	TDK	MLG1005S6N8JT
R1	0402	DNI	DNI	–	–
R2, R4	0402	0 Ω	0 Ω	Panasonic	ERJ-2GE0R00X
R3	0402	5.1 kΩ	3.6 kΩ	Panasonic	ERJ-2GEJ512X (5.1 kΩ) ERJ-2GEJ362X (3.6 kΩ)

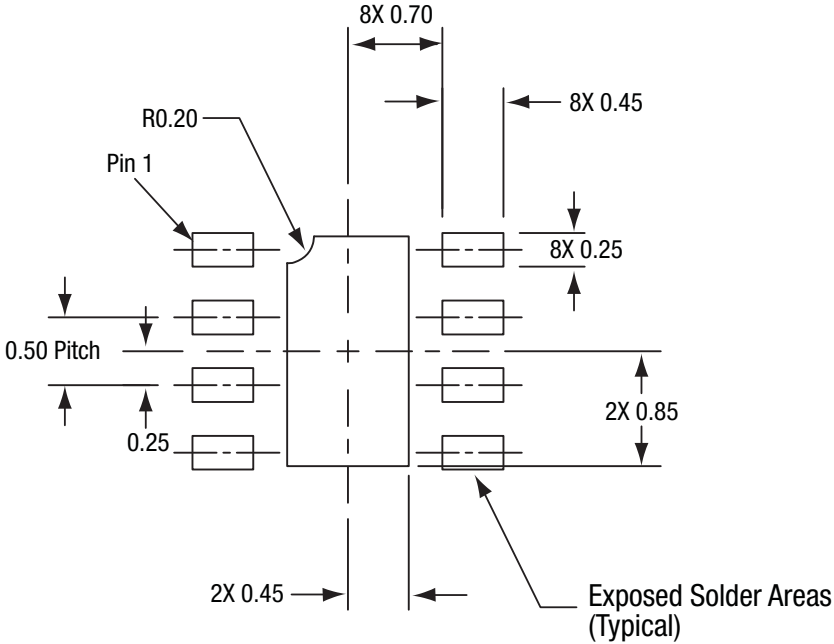

All dimensions are in millimeters

S1413

Figure 24. SKY67022-396LF PCB Layout Footprint (Top View)

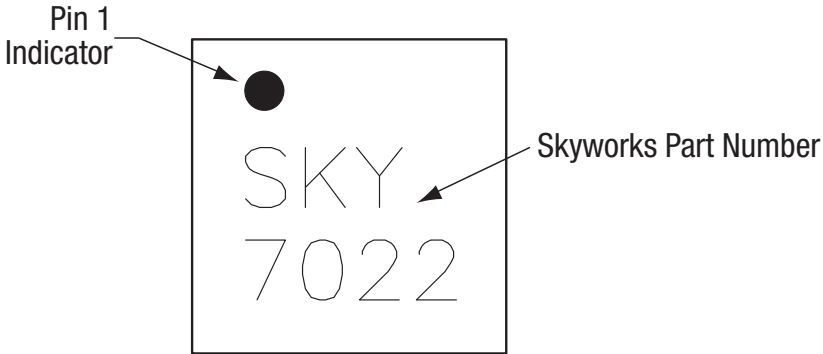
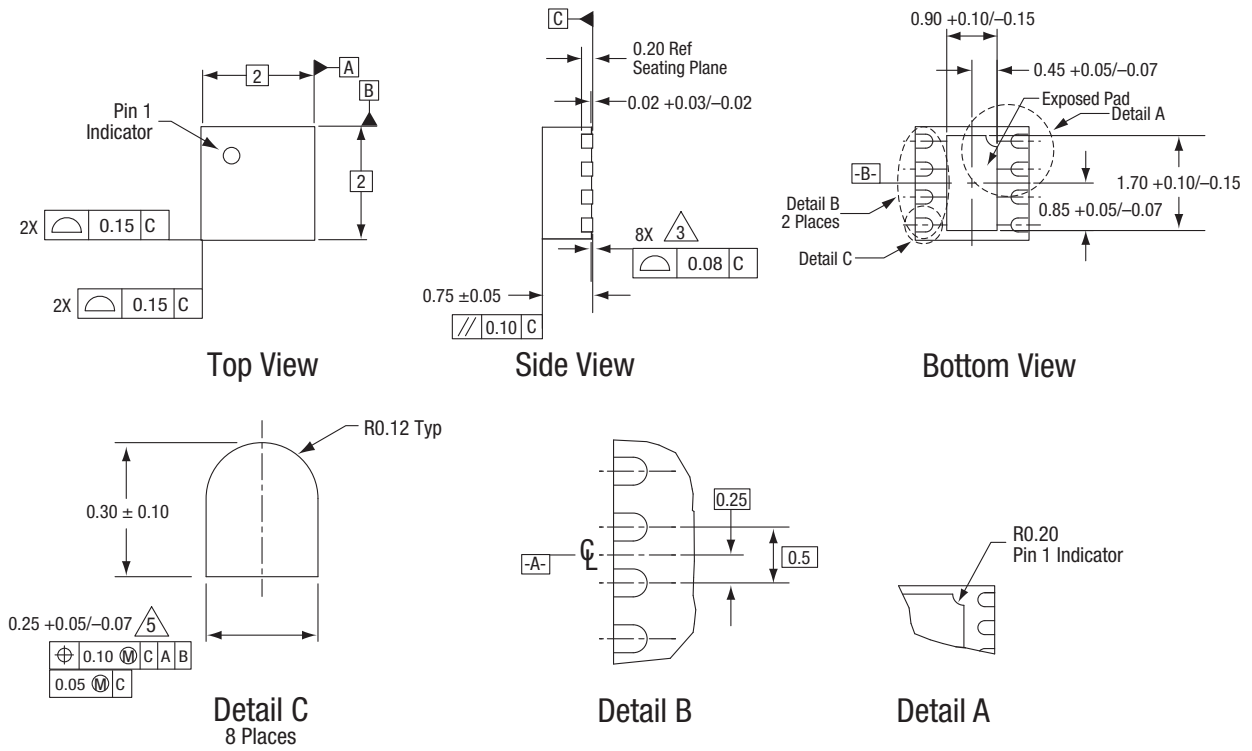

Figure 25. Typical Part Markings (Top View)



Notes:

1. All measurements are in millimeters.
2. Dimensions and tolerances according to ASME Y14.5M-1994.
3. Coplanarity applies to the exposed heat sink ground pad as well as the terminals.
4. Plating requirement per source control drawing (SCD) 2504.
5. Dimension applies to metallized terminal and is measured between 0.15 mm and 0.30 mm from terminal tip.

S1945

Figure 26. SKY67022-396LF Package Dimensions

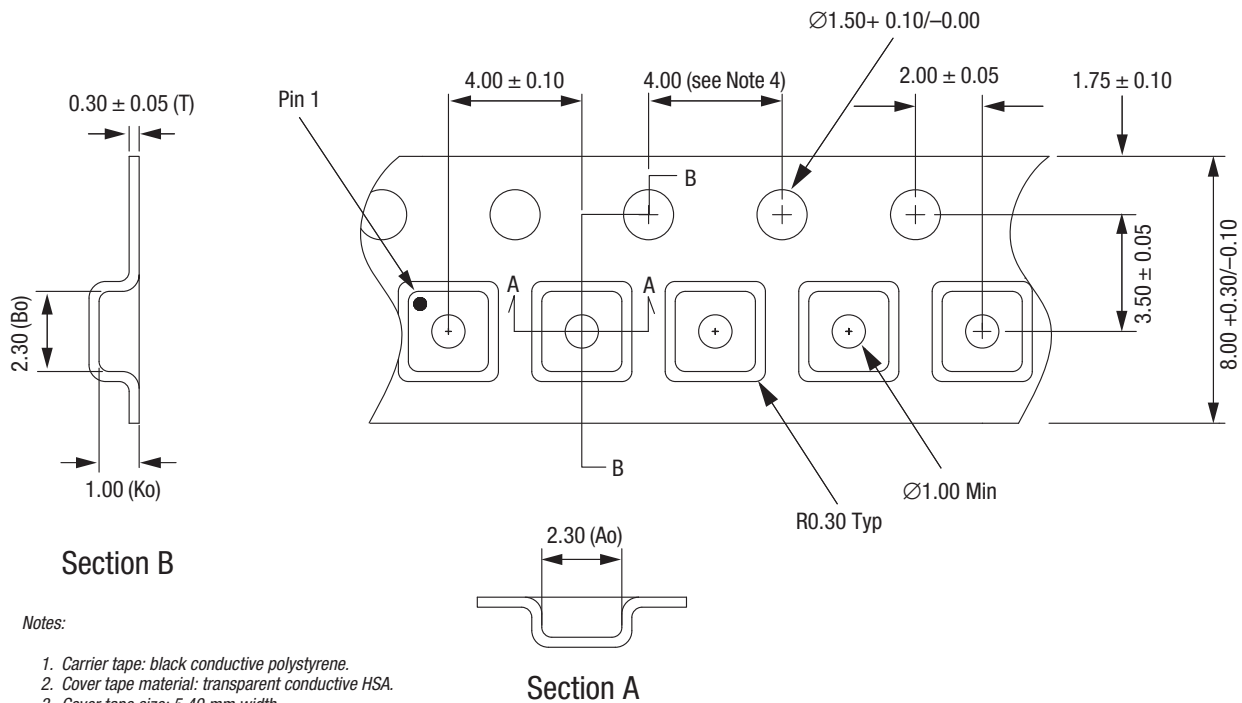

Notes:

1. Carrier tape: black conductive polystyrene.
2. Cover tape material: transparent conductive HSA.
3. Cover tape size: 5.40 mm width.
4. Ten sprocket hole pitch cumulative tolerance = ±0.20 mm.
5. ESD surface resistivity is $\leq 1 \times 10^9$ Ohms/square per EIA, JEDEC tape and reel specification.
6. Ao and Bo measurement point to be 0.30 mm from bottom pocket.
7. All measurements are in millimeters.

S1601

Figure 27. SKY67022-396LF Tape and Reel Dimensions

Ordering Information

Model Name	Manufacturing Part Number	Evaluation Board Part Number
SKY67022-396LF LNA	SKY67022-396LF	SKY67022-396LF-EVB

Copyright © 2013, 2016, 2017 Skyworks Solutions, Inc. All Rights Reserved.

Information in this document is provided in connection with Skyworks Solutions, Inc. (“Skyworks”) products or services. These materials, including the information contained herein, are provided by Skyworks as a service to its customers and may be used for informational purposes only by the customer. Skyworks assumes no responsibility for errors or omissions in these materials or the information contained herein. Skyworks may change its documentation, products, services, specifications or product descriptions at any time, without notice. Skyworks makes no commitment to update the materials or information and shall have no responsibility whatsoever for conflicts, incompatibilities, or other difficulties arising from any future changes.

No license, whether express, implied, by estoppel or otherwise, is granted to any intellectual property rights by this document. Skyworks assumes no liability for any materials, products or information provided hereunder, including the sale, distribution, reproduction or use of Skyworks products, information or materials, except as may be provided in Skyworks Terms and Conditions of Sale.

THE MATERIALS, PRODUCTS AND INFORMATION ARE PROVIDED “AS IS” WITHOUT WARRANTY OF ANY KIND, WHETHER EXPRESS, IMPLIED, STATUTORY, OR OTHERWISE, INCLUDING FITNESS FOR A PARTICULAR PURPOSE OR USE, MERCHANTABILITY, PERFORMANCE, QUALITY OR NON-INFRINGEMENT OF ANY INTELLECTUAL PROPERTY RIGHT; ALL SUCH WARRANTIES ARE HEREBY EXPRESSLY DISCLAIMED. SKYWORKS DOES NOT WARRANT THE ACCURACY OR COMPLETENESS OF THE INFORMATION, TEXT, GRAPHICS OR OTHER ITEMS CONTAINED WITHIN THESE MATERIALS. SKYWORKS SHALL NOT BE LIABLE FOR ANY DAMAGES, INCLUDING BUT NOT LIMITED TO ANY SPECIAL, INDIRECT, INCIDENTAL, STATUTORY, OR CONSEQUENTIAL DAMAGES, INCLUDING WITHOUT LIMITATION, LOST REVENUES OR LOST PROFITS THAT MAY RESULT FROM THE USE OF THE MATERIALS OR INFORMATION, WHETHER OR NOT THE RECIPIENT OF MATERIALS HAS BEEN ADVISED OF THE POSSIBILITY OF SUCH DAMAGE.

Skyworks products are not intended for use in medical, lifesaving or life-sustaining applications, or other equipment in which the failure of the Skyworks products could lead to personal injury, death, physical or environmental damage. Skyworks customers using or selling Skyworks products for use in such applications do so at their own risk and agree to fully indemnify Skyworks for any damages resulting from such improper use or sale.

Customers are responsible for their products and applications using Skyworks products, which may deviate from published specifications as a result of design defects, errors, or operation of products outside of published parameters or design specifications. Customers should include design and operating safeguards to minimize these and other risks. Skyworks assumes no liability for applications assistance, customer product design, or damage to any equipment resulting from the use of Skyworks products outside of stated published specifications or parameters.

Skyworks and the Skyworks symbol are trademarks or registered trademarks of Skyworks Solutions, Inc., in the United States and other countries. Third-party brands and names are for identification purposes only, and are the property of their respective owners. Additional information, including relevant terms and conditions, posted at www.skyworksinc.com, are incorporated by reference.