



Chipsmall Limited consists of a professional team with an average of over 10 year of expertise in the distribution of electronic components. Based in Hongkong, we have already established firm and mutual-benefit business relationships with customers from,Europe,America and south Asia,supplying obsolete and hard-to-find components to meet their specific needs.

With the principle of “Quality Parts,Customers Priority,Honest Operation,and Considerate Service”,our business mainly focus on the distribution of electronic components. Line cards we deal with include Microchip,ALPS,ROHM,Xilinx,Pulse,ON,Everlight and Freescale. Main products comprise IC,Modules,Potentiometer,IC Socket,Relay,Connector.Our parts cover such applications as commercial,industrial, and automotives areas.

We are looking forward to setting up business relationship with you and hope to provide you with the best service and solution. Let us make a better world for our industry!



Contact us

Tel: +86-755-8981 8866 Fax: +86-755-8427 6832

Email & Skype: info@chipsmall.com Web: www.chipsmall.com

Address: A1208, Overseas Decoration Building, #122 Zhenhua RD., Futian, Shenzhen, China



DATA SHEET

SKY67150-396LF: 300 to 2200 MHz Ultra Low-Noise Amplifier

Applications

- LTE, GSM, WCDMA, HSDPA macro and micro base stations
- UHF and L-band ultra low-noise receivers
- Cellular repeaters, DAS and RRH/RRUs
- High temperature transceiver applications to +105 °C

Features

- Ultra-low Evaluation Board NF of 0.23 dB @ 849 MHz
- High OIP3 performance: +39 dBm
- Adjustable supply current from 20 to 100 mA
- Flexible bias voltage: 3 to 5 V
- Temperature and process-stable active bias
- Miniature DFN (8-pin, 2 x 2 mm) package (MSL1 @ 260 °C per JEDEC J-STD-020)



Skyworks Green™ products are compliant with all applicable legislation and are halogen-free. For additional information, refer to *Skyworks Definition of Green™*, document number SQ04-0074.

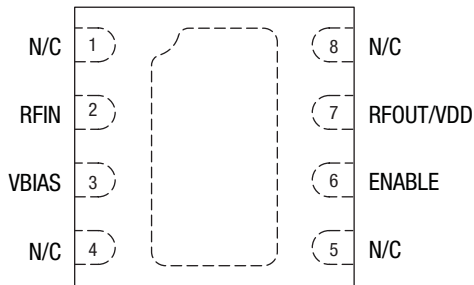

Figure 2. SKY67150-396LF Pinout (Top View)

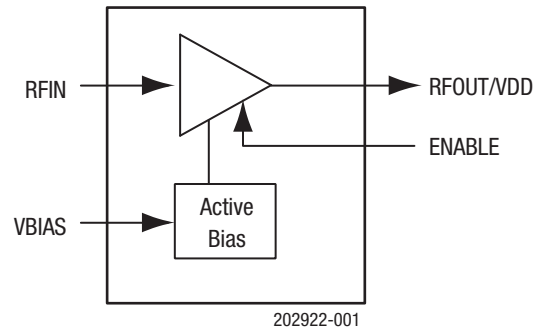

Figure 1. SKY67150-396LF Block Diagram

Description

The SKY67150-396LF is GaAs, pHEMT low-noise amplifier (LNA) with an active bias, high linearity, superior gain, and industry-leading noise figure (NF) performance. The device features Skyworks advanced, pHEMT enhancement mode process in a compact 2 x 2 mm, 8-pin Dual Flat No-Lead (DFN) package.

The internal active bias circuitry provides stable performance over temperature and process variation. The device offers the ability to externally adjust supply current. Supply voltage is applied to the RFOUT/VDD pin through an RF choke inductor. The RFIN and RFOUT/VDD pins should be DC blocked to ensure proper operation.

The SKY67150-396LF operates in the frequency range of 300 to 2200 MHz using a common layout and band-specific tunes. Operation with high gain and a low NF at frequencies as low as 100 MHz is possible with degraded input return loss.

A functional block diagram is shown in Figure 1. The pin configuration and package are shown in Figure 2. Signal pin assignments and functional pin descriptions are provided in Table 1.

Table 1. SKY67150-396LF Signal Descriptions

Pin	Name	Description	Pin	Name	Description
1	N/C	No connection. May be connected to ground with no change in performance.	5	N/C	No connection. May be connected to ground with no change in performance.
2	RFIN	RF input. DC blocking capacitor required.	6	ENABLE	Enable pin. Active low = amplifier "on" state
3	VBIAS	Bias voltage for input gate. External resistor sets current consumption.	7	RFOUT/VDD	RF output. Apply VDD through RF choke inductor. DC blocking capacitor required.
4	N/C	No connection. May be connected to ground with no change in performance.	8	N/C	No connection. May be connected to ground with no change in performance.

Electrical and Mechanical Specifications

The absolute maximum ratings of the SKY67150-396LF are provided in Table 2. Electrical specifications are provided in Tables 3 through 7.

Typical performance characteristics are illustrated in Figures 3 through 21.

Table 2. SKY67150-396LF Absolute Maximum Ratings¹

Parameter	Symbol	Minimum	Maximum	Units
Supply voltage	V _{DD}		5.5	V
Quiescent supply current	I _{DQ}		120	mA
RF input power	P _{IN}		+21	dBm
Storage temperature	T _{STG}	-40	+150	°C
Operating temperature	T _A	-40	+105	°C
Junction temperature	T _J		+150	°C
Electrostatic discharge:	ESD			
Charged Device Model (CDM), Class 4			1000	V
Human Body Model (HBM), Class 1A			250	V
Machine Model (MM), Class A			30	V

¹ Exposure to maximum rating conditions for extended periods may reduce device reliability. There is no damage to device with only one parameter set at the limit and all other parameters set at or below their nominal value. Exceeding any of the limits listed here may result in permanent damage to the device.

ESD HANDLING: Although this device is designed to be as robust as possible, electrostatic discharge (ESD) can damage this device. This device must be protected at all times from ESD when handling or transporting. Static charges may easily produce potentials of several kilovolts on the human body or equipment, which can discharge without detection. Industry-standard ESD handling precautions should be used at all times.

Table 3. SKY67150-396LF Electrical Specifications: Thermal Data¹
(V_{DD} = 5 V, T_A = +25 °C, P_{IN} = -25 dBm, Characteristic Impedance [Z₀] = 50 Ω, Unless Otherwise Noted)

Parameter	Symbol	Test Condition	Min	Typical	Max	Units
Thermal resistance	θ _{JC}			45		°C/W
Channel temperature @ +85 °C reference (package heat slug)		V _{DD} = 5 V, I _{DQ} = 82 mA, no RF applied, dissipated power = 0.35 W		103		°C

¹ Performance is guaranteed only under the conditions listed in this table.

Table 4. SKY67150-396LF Electrical Specifications: 650 to 1100 MHz Optimized Tuning¹
(V_{DD} = 5 V, T_A = +25 °C, P_{IN} = -20 dBm, Characteristic Impedance [Z₀] = 50 Ω, Unless Otherwise Noted)

Parameter	Symbol	Test Condition	Min	Typical	Max	Units
RF Specifications						
Noise figure	NF	@ 849 MHz, includes Evaluation Board loss		0.23	0.38	dB
Small signal gain	IS21I	@ 849 MHz	19.0	20.5		dB
Input return loss	IS11I	@ 849 MHz		11		dB
Output return loss	IS22I	@ 849 MHz		20		dB
Reverse isolation	IS12I	@ 849 MHz		28		dB
Third order input intercept point	IIP3	@ 849 MHz, Δf = 1 MHz, P _{IN} = -20 dBm/tone	+15.5	+18.5		dBm
Third order output intercept point	OIP3	@ 849 MHz, Δf = 1 MHz, P _{IN} = -20 dBm/tone	+36	+39		dBm
1 dB input compression point	IP1dB	@ 849 MHz	-0.5	+1.5		dBm
1 dB output compression point	OP1dB	@ 849 MHz	+19	+21		dBm
DC Specifications						
Supply voltage	V _{DD}			5		V
Quiescent supply current	I _{DQ}	Set with external resistor	70	82	95	mA
Bias current	I _{BIAS}			500		μA
Enable voltage: Gain mode	V _{ENABLE}		0		0.2	V
Power-down mode			1.5		5.5	V
Enable rise time ²	T _R	@ 849 MHz		250	500	ns
Enable fall time ²	T _F	@ 849 MHz		250	500	ns

¹ Performance is guaranteed only under the conditions listed in this table.

² Tested with a 100 kHz square wave, 1000 pF capacitance-to-ground on the ENABLE pin. Switching time can be improved by reducing the value of, or eliminating, the 1000 pF capacitor on pin 6 (component M17 in Figure 24).

Typical Performance Characteristics, 650 to 1100 MHz

(VDD = 5 V, TA = +25 °C, PIN = -20 dBm, Characteristic Impedance [Zo] = 50 Ω, Unless Otherwise Noted)

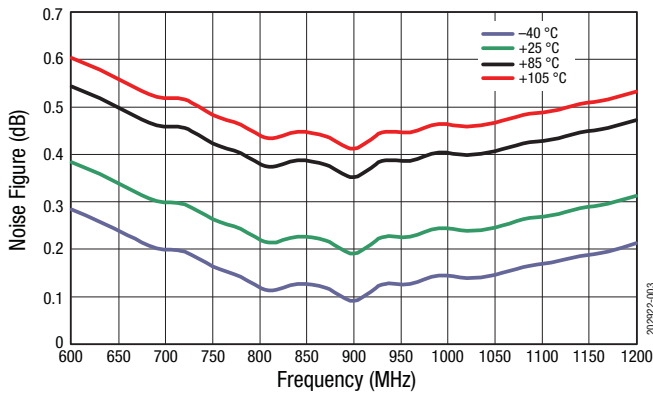

Figure 3. Evaluation Board NF vs Frequency over Temperature

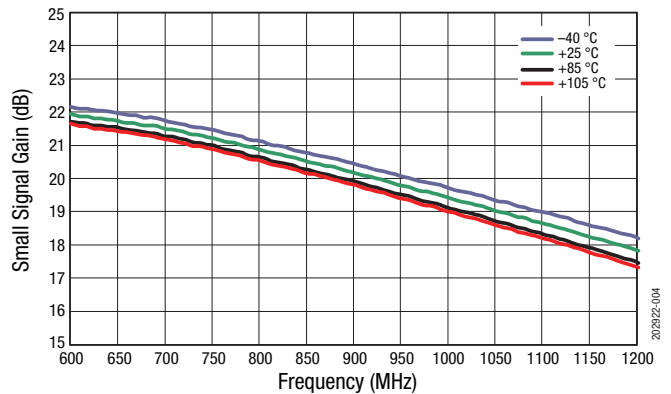

Figure 4. Narrow Band Gain vs Frequency over Temperature

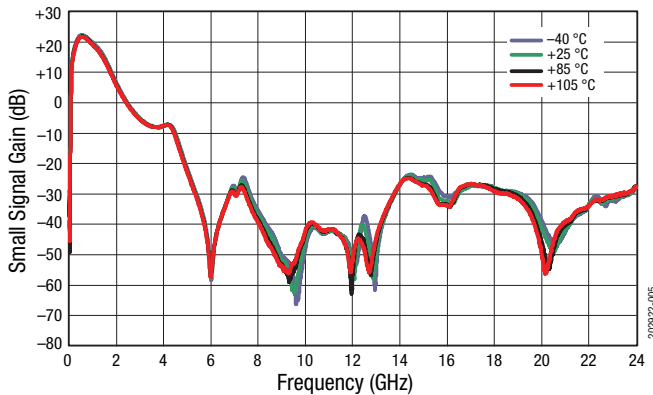

Figure 5. Broadband Gain vs Frequency over Temperature

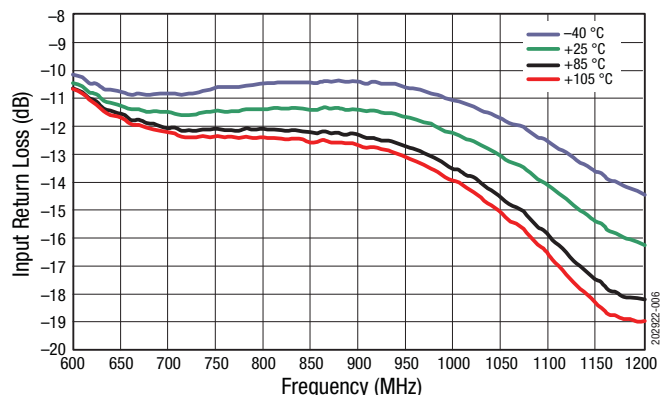

Figure 6. Narrowband Input Return Loss vs Frequency over Temperature

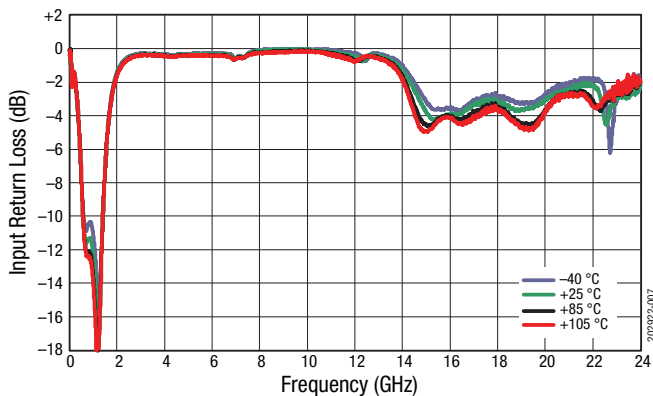

Figure 7. Broadband Input Return Loss vs Frequency over Temperature

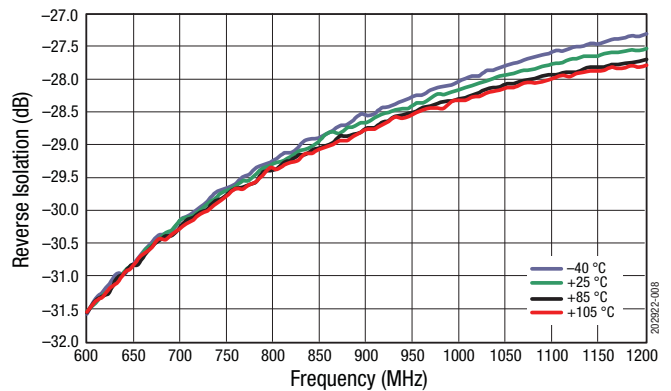

Figure 8. Narrowband Reverse Isolation vs Frequency over Temperature

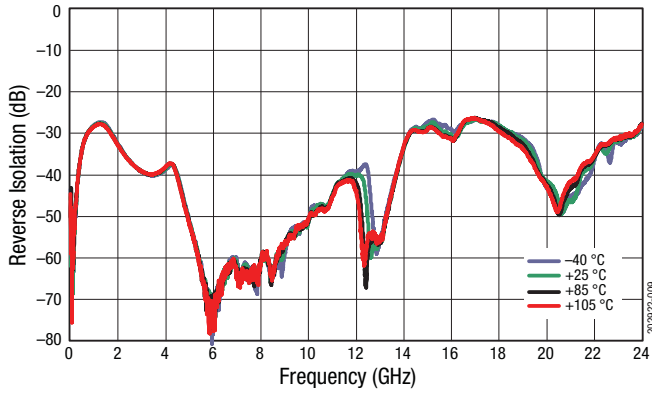

Figure 9. Broadband Reverse Isolation vs Frequency over Temperature

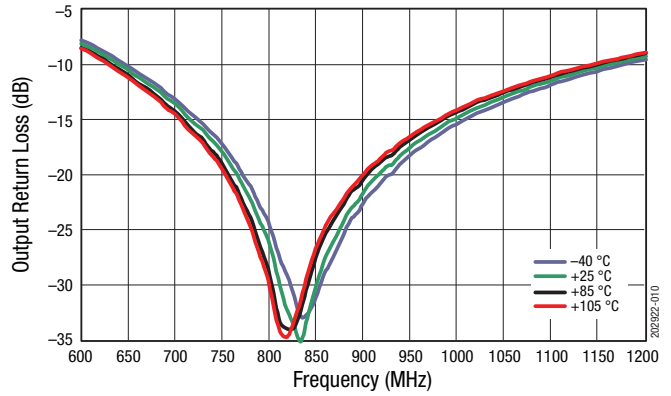

Figure 10. Narrowband Output Return Loss vs Frequency over Temperature

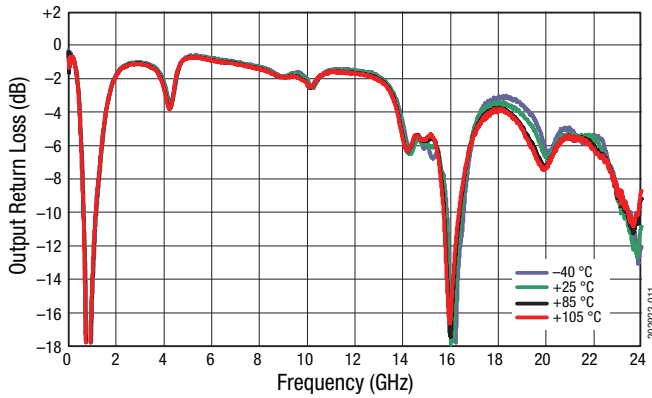

Figure 11. Broadband Output Return Loss vs Frequency over Temperature

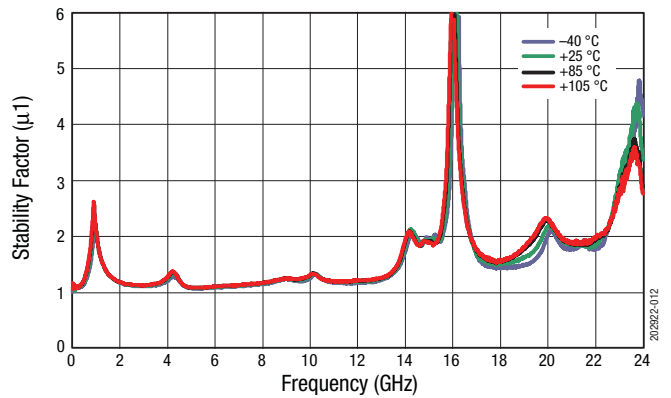

Figure 12. Stability Factor (μ_1) vs Frequency over Temperature

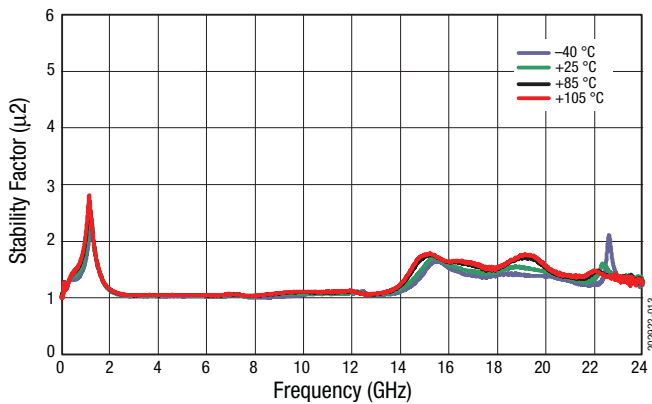

Figure 13. Stability Factor (μ_2) vs Frequency over Temperature

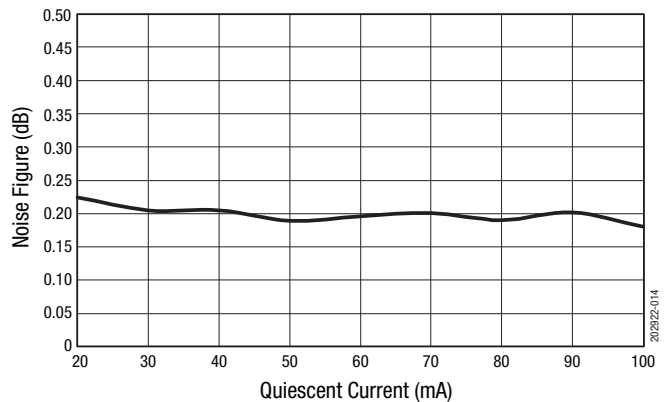

Figure 14. Evaluation Board NF vs Quiescent Current over Frequency Using Band-Specific BOM (@ 849 MHz)

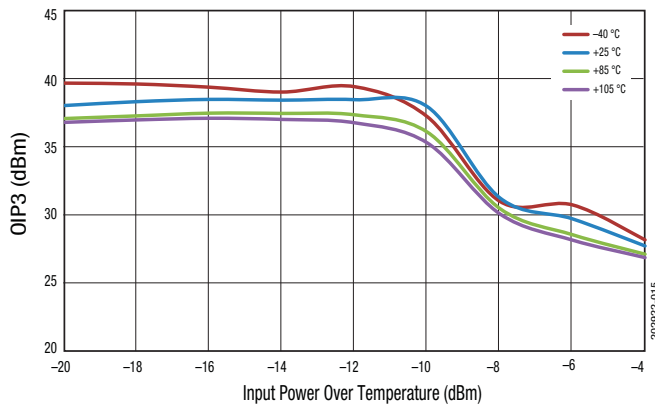

Figure 15. OIP3 vs Input Power Over Temperature (@849 MHz, 1MHz Spacing)

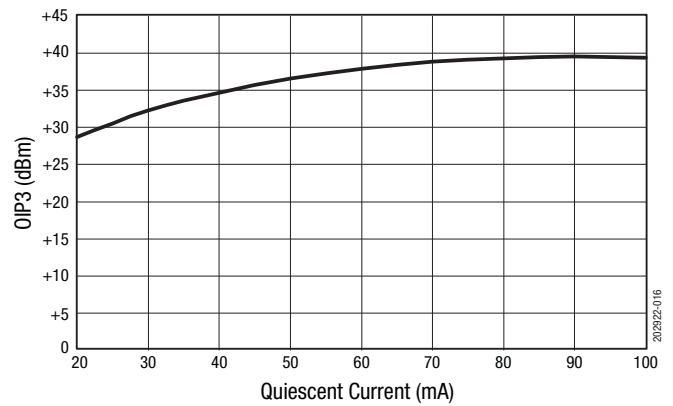

Figure 16. OIP3 vs Quiescent Current over Frequency Using Band-Specific BOM (@ 849 MHz)

Table 5. SKY67150-396LF Electrical Specifications: 380 to 530 MHz Optimized Tuning¹
(V_{DD} = 5 V, T_A = +25 °C, P_{IN} = -25 dBm, Characteristic Impedance [Z₀] = 50 Ω, Unless Otherwise Noted)

Parameter	Symbol	Test Condition	Min	Typical	Max	Units
RF Specifications						
Noise figure	NF	@ 450 MHz, includes Evaluation Board loss		0.45	0.60	dB
Small signal gain	IS21I	@ 450 MHz	21.5	23.0		dB
Input return loss	IS11I	@ 450 MHz		12		dB
Output return loss	IS22I	@ 450 MHz		20		dB
Reverse isolation	IS12I	@ 450 MHz		33		dB
Third order input intercept point	IIP3	@ 450 MHz, Δf = 1 MHz, P _{IN} = -25 dBm/tone	+10	+13		dBm
Third order output intercept point	OIP3	@ 450 MHz, Δf = 1 MHz, P _{IN} = -25 dBm/tone	+33	+36		dBm
1 dB input compression point	IP1dB	@ 450 MHz	-5	-3		dBm
1 dB output compression point	OP1dB	@ 450 MHz	+17	+19		dBm
DC Specifications						
Supply voltage	V _{DD}			5		V
Quiescent supply current	I _{DD}	Set with external resistor		82		mA
Bias current	I _{BIAS}			500		μA
Enable rise time ²	T _R	@ 450 MHz		250	500	ns
Enable fall time ²	T _F	@ 450 MHz		250	500	ns

¹ Performance is guaranteed only under the conditions listed in this table.

² Tested with a 100 kHz square wave, 1000 pF capacitance-to-ground on the ENABLE pin. Switching time can be improved by reducing the value of, or eliminating, the 1000 pF capacitor on pin 6 (component M17 in Figure 24).

Table 6. SKY67150-396LF Electrical Specifications: 1400 to 2200 MHz Optimized Tuning¹
(V_{DD} = 5 V, T_A = +25 °C, P_{IN} = -25 dBm, Characteristic Impedance [Z₀] = 50 Ω, Unless Otherwise Noted)

Parameter	Symbol	Test Condition	Min	Typical	Max	Units
RF Specifications						
Noise figure	NF	@ 1900 MHz, includes Evaluation Board loss		0.38	0.53	dB
Small signal gain	IS21I	@ 1900 MHz	13.0	14.5		dB
Input return loss	IS11I	@ 1900 MHz		17		dB
Output return loss	IS22I	@ 1900 MHz		20		dB
Reverse isolation	IS12I	@ 1900 MHz		23		dB
Third order input intercept point	IIP3	@ 1900 MHz, Δf = 1 MHz, P _{IN} = -25 dBm/tone	+19	+22		dBm
Third order output intercept point	OIP3	@ 1900 MHz, Δf = 1 MHz, P _{IN} = -25 dBm/tone	+33.5	+36.5		dBm
1 dB input compression point	IP1dB	@ 1900 MHz	+2.5	+4.5		dBm
1 dB output compression point	OP1dB	@ 1900 MHz	+16	+18		dBm
DC Specifications						
Supply voltage	V _{DD}			5		V
Quiescent supply current	I _{DQ}	Set with external resistor		82		mA
Bias current	I _{BIAS}			500		μA
Enable rise time ²	T _R	@ 1900 MHz		250	500	ns
Enable fall time ²	T _F	@ 1900 MHz		250	500	ns

¹ Performance is guaranteed only under the conditions listed in this table.

² Tested with a 100 kHz square wave, 1000 pF capacitance-to-ground on the ENABLE pin. Switching time can be improved by reducing the value of, or eliminating, the 1000 pF capacitor on pin 6 (component M17 in Figure 24).

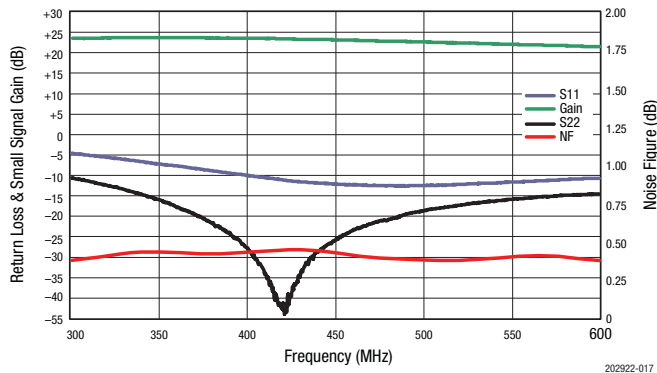

Figure 17. Evaluation Board NF, Gain, and Return Losses for 380 to 530 MHz Tuning

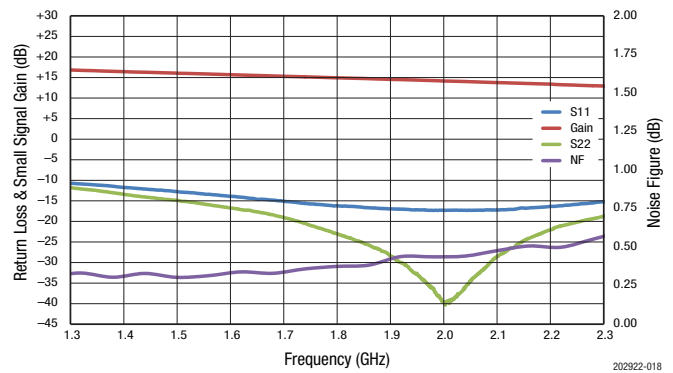

Figure 18. Evaluation Board NF, Gain, and Return Losses for 1400 to 2200 MHz Tuning

Table 7. Noise Parameters vs Frequency (@ +25 °C, 5 V, 70 mA)

Frequency (GHz)	FMIN (dB)	Gamma opt (Mag)	Gamma opt (Phase)	Noise Resistance (RN) (Ω)	Associated Gain (dB)	Maximum Gain (GMAX) (dB)
0.4	0.3356	0.3898	-1.65	0.063	26.874	26.7297
0.45	0.3187	0.3471	2.44	0.0318	26.112	26.0677
0.5	0.3287	0.1473	-60.08	0.0484	25.6849	25.666
0.55	0.303	0.3392	6.77	0.0432	24.8282	24.8229
0.6	0.2702	0.2931	7.19	0.0347	24.2668	24.2489
0.65	0.2682	0.3336	19.52	0.0416	23.7339	23.7001
0.7	0.2735	0.3735	15.75	0.0508	23.2435	23.2303
0.75	0.2517	0.3303	18.12	0.0434	22.7786	22.7593
0.8	0.1996	0.2104	40.79	0.0494	22.3308	22.1323
0.85	0.1908	0.334	16.5	0.0628	21.9055	21.8755
0.9	0.1925	0.373	21	0.0341	21.501	21.4886
0.95	0.1946	0.3857	39.09	0.0271	21.1104	21.0495
1.1	0.2164	0.3831	34.68	0.0574	20.0289	20.0043
1.2	0.2327	0.3597	40.72	0.0665	19.3803	19.3273
1.3	0.2482	0.3419	41.76	0.049	18.7816	18.703
1.4	0.2798	0.3207	48.16	0.0573	18.2235	18.1058
1.5	0.3092	0.2854	59.17	0.0532	17.7114	17.5101
1.6	0.3287	0.312	75.86	0.0976	17.2272	16.9687
1.8	0.3516	0.4428	68.41	0.1833	16.34	16.2997
2.1	0.4897	0.4233	71.86	0.1996	15.1948	15.1438
2.3	0.5014	0.2079	70.76	0.0591	14.5509	14.0753

Swept F1 Load Gamma Pull
 Freq = 0.4500 GHz
 Γ Source: 0.4332 < 27.58

Ip3 max = 39.29 dBm
 at 0.5981 < 99.88
 5 contours, 0.50 dBm step
 (37.00 to 39.00 dBm)
 Gt max = 27.13 dB
 at 0.1978 < 94.24
 5 contours, 0.50 dB step
 (25.00 to 27.00 dB)
 Specs: OFF

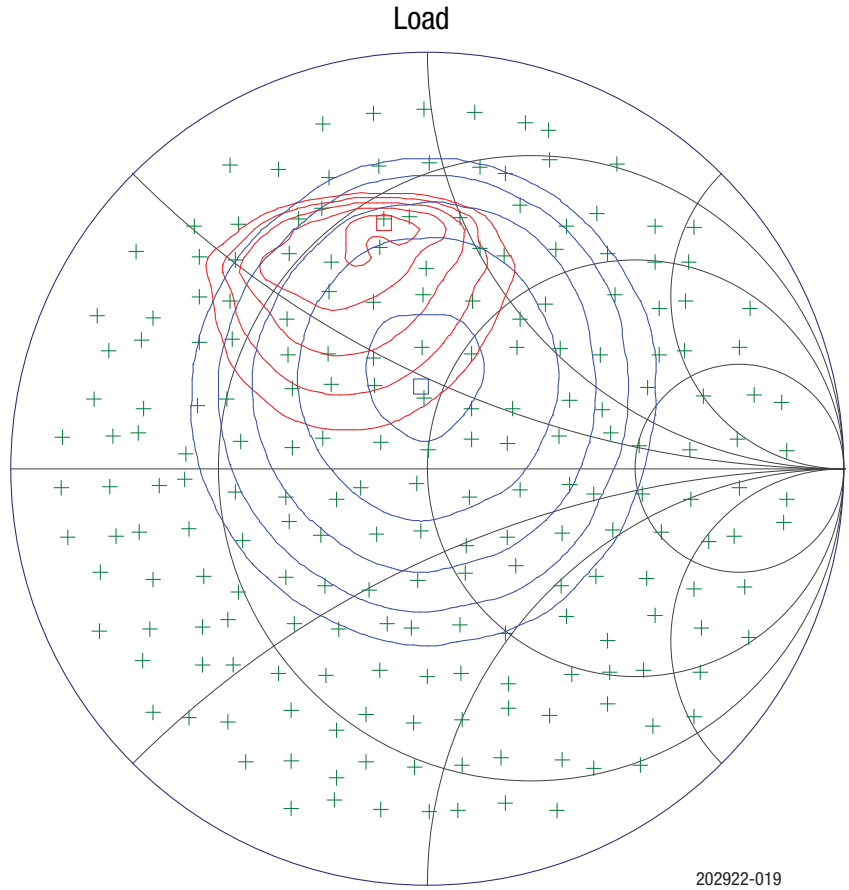

202922-019

Figure 19. OIP3 Load Pull @ 450 MHz, 5 V, 70 mA (Input Load = Min NF, -20 dBm/tone, 5 MHz Spacing)

Swept F1 Load Gamma Pull
Freq = 0.9000 GHz
 Γ Source: 0.3655 < 16.76

Ip3 max = 37.05 dBm
at 0.3107 < 170.63
5 contours, 0.50 dBm step
(35.00 to 37.00 dBm)
Gt max = 21.90 dB
at 0.3914 < 162.55
5 contours, 0.50 dB step
(19.50 to 21.50 dB)
Specs: OFF

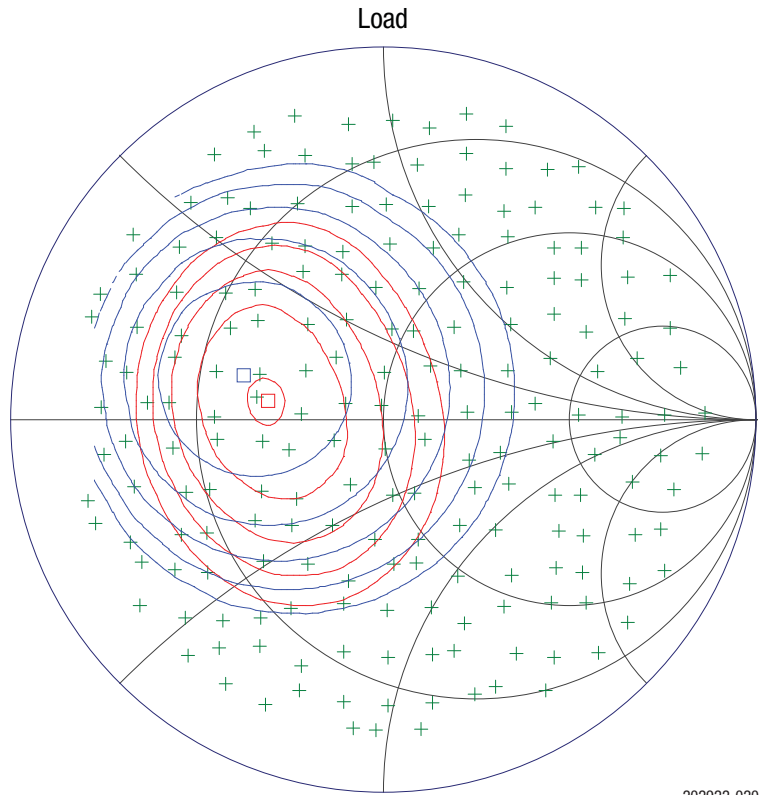

202922-020

Figure 20. OIP3 Load Pull @ 900 MHz, 5 V, 70 mA (Input Load = Min NF, -20 dBm/tone, 5 MHz Spacing)

Swept F1 Load Gamma Pull
 Freq = 1.9000 GHz
 Γ Source: 0.4514 < 66.52

Ip3 max = 35.04 dBm
 at 0.2558 < 76.52
 5 contours, 0.50 dBm step
 (33.00 to 35.00 dBm)
 Gt max = 17.16 dB
 at 0.4627 < 13.81
 5 contours, 0.50 dB step
 (15.00 to 17.00 dB)
 Specs: OFF

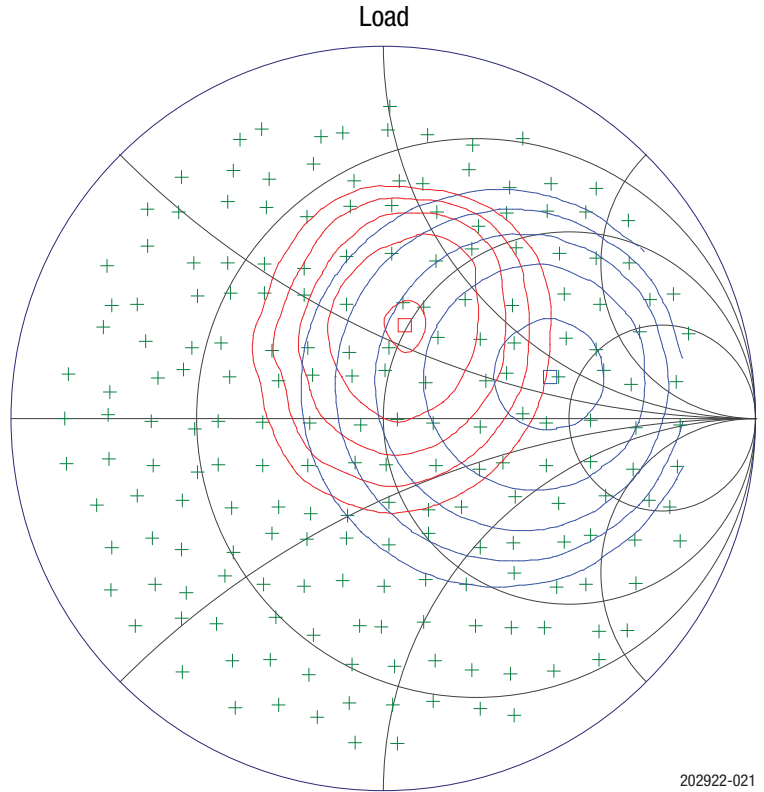

Figure 21. OIP3 Load Pull @1900 MHz, 5 V, 70 mA (Input Load = Min NF, -20 dBm/tone, 5 MHz Spacing)

Evaluation Board Description

The SKY67150-396LF Evaluation Board is used to test the performance of the SKY67150-396LF LNA. Three different boards are available for different frequency operations: 380 to 530 MHz, 650 to 1100 MHz, and 1400 to 2200 MHz.

An assembly drawing for the Evaluation Board is shown in Figure 22. The layer detail is provided in Figure 23. An Evaluation Board schematic diagram is provided in Figure 24. Tables 8, 9, and 10 provide the Bill of Materials (BOM) list for the three different Evaluation Board tuning frequencies.

Package Dimensions

The PCB layout footprint for the SKY67150-396LF is provided in Figure 25. Typical part markings are shown in Figure 26. Package dimensions are shown in Figure 27, and tape and reel dimensions are provided in Figure 28.

Package and Handling Information

Instructions on the shipping container label regarding exposure to moisture after the container seal is broken must be followed. Otherwise, problems related to moisture absorption may occur when the part is subjected to high temperature during solder assembly.

The SKY67150-396LF is rated to Moisture Sensitivity Level 1 (MSL1) at 260 °C. It can be used for lead or lead-free soldering. For additional information, refer to the Skyworks Application Note, *Solder Reflow Information*, document number 200164.

Care must be taken when attaching this product, whether it is done manually or in a production solder reflow environment. Production quantities of this product are shipped in a standard tape and reel format.

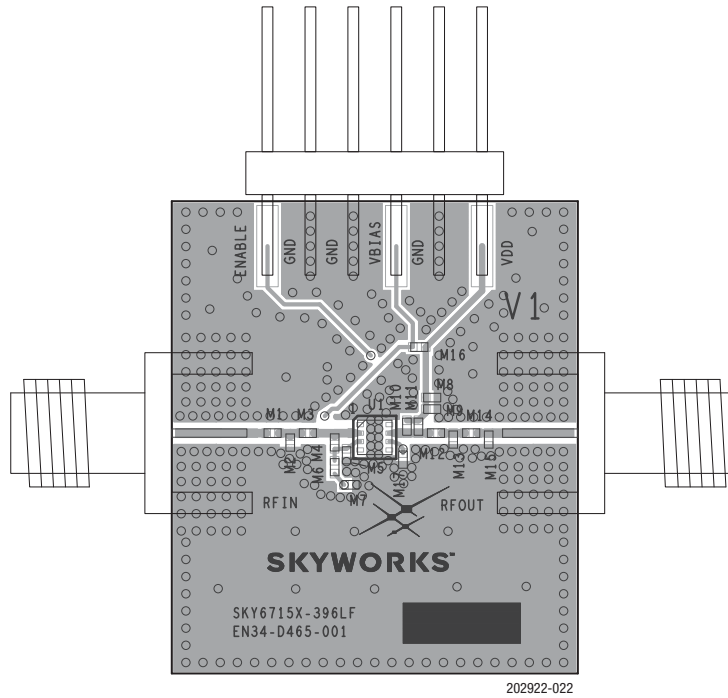

Figure 22. SKY67150-396LF Evaluation Board Assembly Diagram

Cross Section	Name	Thickness (mm)	Material
	MSK-NS		
	TRA-NS	0.03556	Cu foil
	Laminate	0.254 ± 0.152	Rogers 4350B
	TRA-2	0.0178	Cu foil
	Laminate	0.889 nom.	FR4 Prepreg (Note 1)
	TRA-3	0.0178	Cu foil
	Laminate	0.254 ± 0.152	FR4 Core
	TRA-FS	0.0178	Cu foil
	MSK-PS		

Note 1: Adjust this thickness to meet total thickness goal.

General Notes:

Material: Rogers R04350, $\epsilon_r = 3.66$
 Layer 1 thickness: 0.254 mm
 Overall board thickness: 1.575 mm
 50 Ω transmission line width: 0.522 mm
 Coplanar ground spacing: 0.394 mm
 Via diameter: 0.254 mm

202922-023

Figure 23. Layer Detail Physical Characteristics

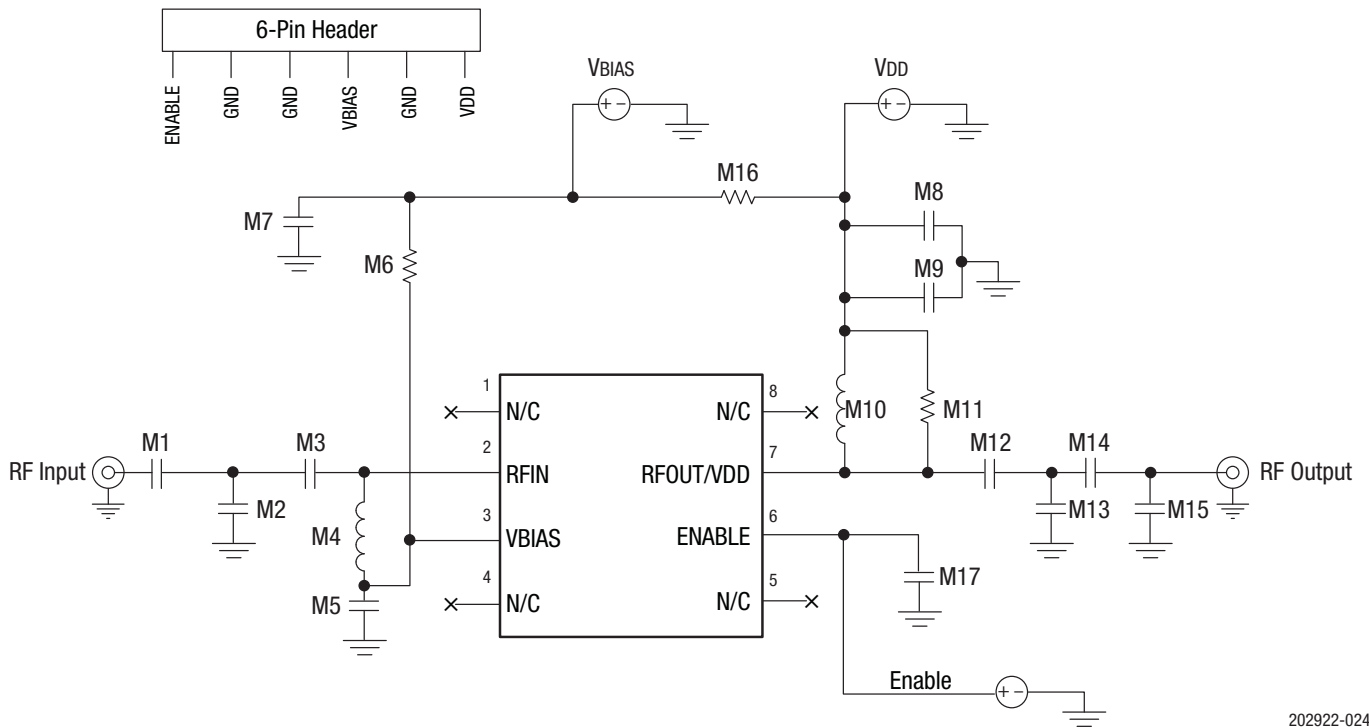

202922-024

Figure 24. SKY67150-396LF Evaluation Board Schematic

Table 8. SKY67150-396LF Evaluation Board Bill of Materials (650 to 1100 MHz Tuning)

Component	Description	Value	Size	Manufacturer	Part Number
M1	Inductor	8.2 nH	0603	Coilcraft HP	0603HP-8N2X_L
M2, M7		DNP			
M3	Capacitor	20 pF	0402	Murata GJM	GJM1555C1H200JB01
M4	Inductor	100 nH	0402	Coilcraft HP	0402HPH-R10X_L
M5, M17	Capacitor	1000 pF	0402	Murata GRM	GRM1555C1H102JZ01
M6	Resistor	9.1 kΩ	0402	Kamaya RMC, 1/16S 1%	RMC1/16S-9101FTH
M8	Capacitor	10000 pF	0402	Murata GRM	GRM155R71H103KA88
M9, M12	Capacitor	10 pF	0402	Murata GRM	GRM1555C1H100JZ01
M10	Inductor	10 nH	0402	Murata LQG	LQG15HS10NJ02
M11	Resistor	562 Ω	0402	Kamaya RMC, 1/16S 1%	RMC1/16SK5620FTH
M13	Capacitor	2.2 pF	0402	Murata GRM	GRM1555C1H2R2CZ01
M14, M16	Resistor	0 Ω	0402	Kamaya RMC, 1/16S	RMC1/16SJPTH
M15	Resistor	1 kΩ	0402	Kamaya RMC, 1/16S 1%	RMC1/16SK1001FTH

Table 9. SKY67150-396LF Evaluation Board Bill of Materials (380 to 530 MHz Tuning)

Component	Description	Value	Size	Manufacturer	Part Number
M1	Inductor	12 nH	0603	Coilcraft HP	0603HP-12NX_L
M2, M7, M15		DNP			
M3	Capacitor	20 pF	0402	Murata GJM	GJM1555C1H200JB01
M4	Inductor	150 nH	0402	Coilcraft HP	0402HPH-R15X_L
M5, M17	Capacitor	1000 pF	0402	Murata GRM	GRM1555C1H102JZ01
M6	Resistor	9.1 k Ω	0402	Kamaya RMC, 1/16S 1%	RMC1/16S-9101FTH
M8	Capacitor	10000 pF	0402	Murata GRM	GRM155R71H103KA88
M9, M12	Capacitor	10 pF	0402	Murata GRM	GRM1555C1H100JZ01
M10	Inductor	22 nH	0402	Murata LQG	LQG15HS22NJ02
M11	Resistor	330 Ω	0402	Kamaya RMC, 1/16S 1%	RMC1/16SK3300FTH
M13	Capacitor	1.8 pF	0402	Murata GRM	GRM1555C1H1R8CZ01
M14	Resistor	15 Ω	0402	Kamaya RMC, 1/16S	RMC1/16SK15R0FTH
M16	Resistor	0 Ω	0402	Kamaya RMC, 1/16S	RMC1/16SJPTH

Table 10. SKY67150-396LF Evaluation Board Bill of Materials (1400 to 2200 MHz Tuning)

Component	Description	Value	Size	Manufacturer	Part Number
M1	Capacitor	20 pF	0402	Murata GJM	GJM1555C1H200JB01
M2		DNP			
M3	Inductor	2.7 nH	0402	Coilcraft HP	0402HP-2N7XJ_L
M4	Inductor	12 nH	0402	Coilcraft HP	0402HP-12NX_L
M5	Capacitor	1000 pF	0402	Murata GRM	GRM1555C1H102JZ01
M6	Resistor	9.1 k	0402	Kamaya RMC 1/16S 1%	RMC1/16S-9101FTH
M7		DNP			
M8	Capacitor	10,000 pF	0402	Murata GRM	GRM155R71H103KA88
M9	Capacitor	10 pF	0402	Murata GRM	GRM1555C1H100JZ01
M10	Inductor	12 nH	0402	Coilcraft HP	0402HP-12NX_L
M11	Resistor	562 Ω	0402	Kamaya RMC 1/16S 1%	RMC1/16SK5620FTH
M12	Inductor	3.3 nH	0402	Murata LQG	LQG15HS3N3S02
M13		DNP			
M14	Capacitor	100 pF	0402	Murata GRM	GRM1555C1H101JZ01
M15		DNP			
M16	Resistor	0 Ω	0402	Kamaya RMC 1/16S	RMC1/16SJPTH
M17	Capacitor	1000 pF	0402	Murata GRM	GRM1555C1H102JZ01

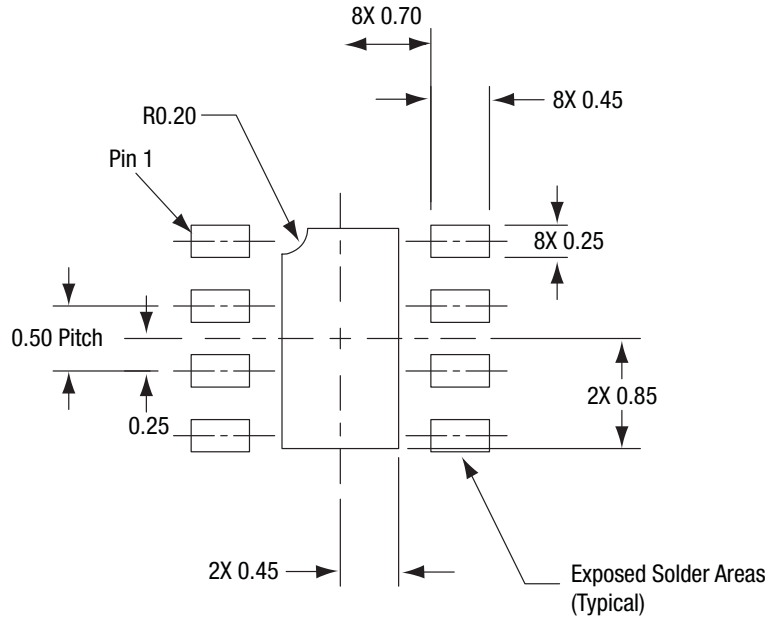

All dimensions are in millimeters

202922-025

Figure 25. SKY67150-396LF PCB Layout Footprint (Top View)

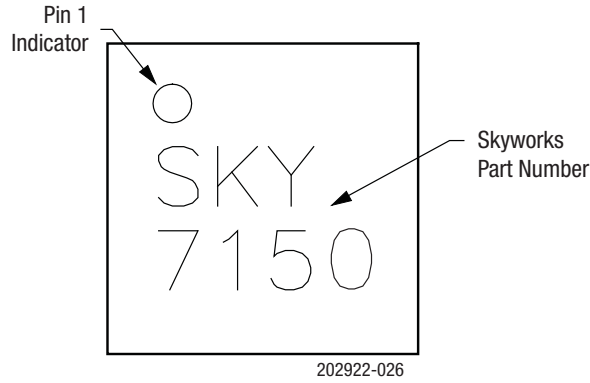
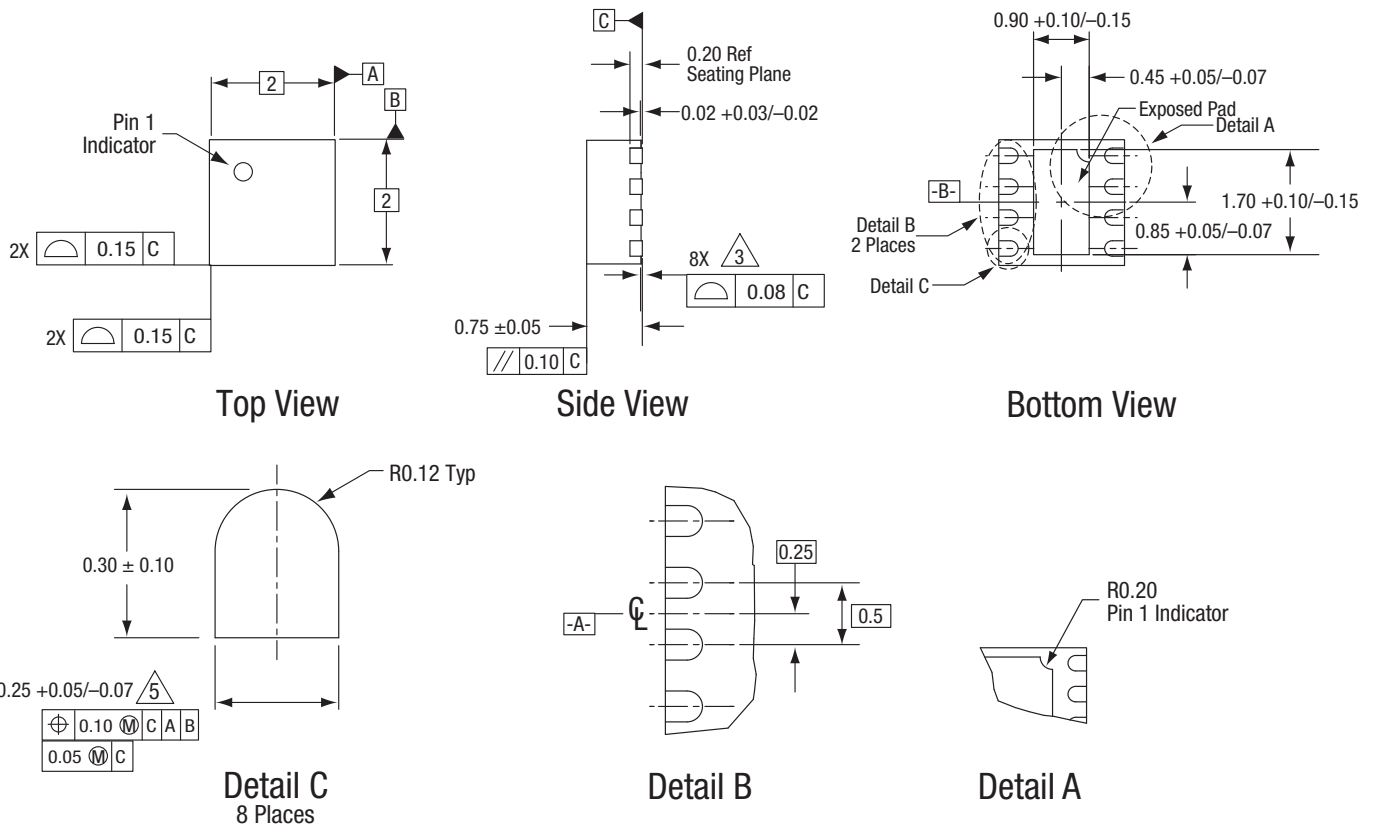

Figure 26. Typical Part Markings (Top View)



Notes:

1. All measurements are in millimeters.
2. Dimensions and tolerances according to ASME Y14.5M-1994.
3. Coplanarity applies to the exposed heat sink ground pad as well as the terminals.
4. Plating requirement per source control drawing (SCD) 2504.
5. Dimension applies to metallized terminal and is measured between 0.15 mm and 0.30 mm from terminal tip.

202922-027

Figure 27. SKY67150-396LF Package Dimensions

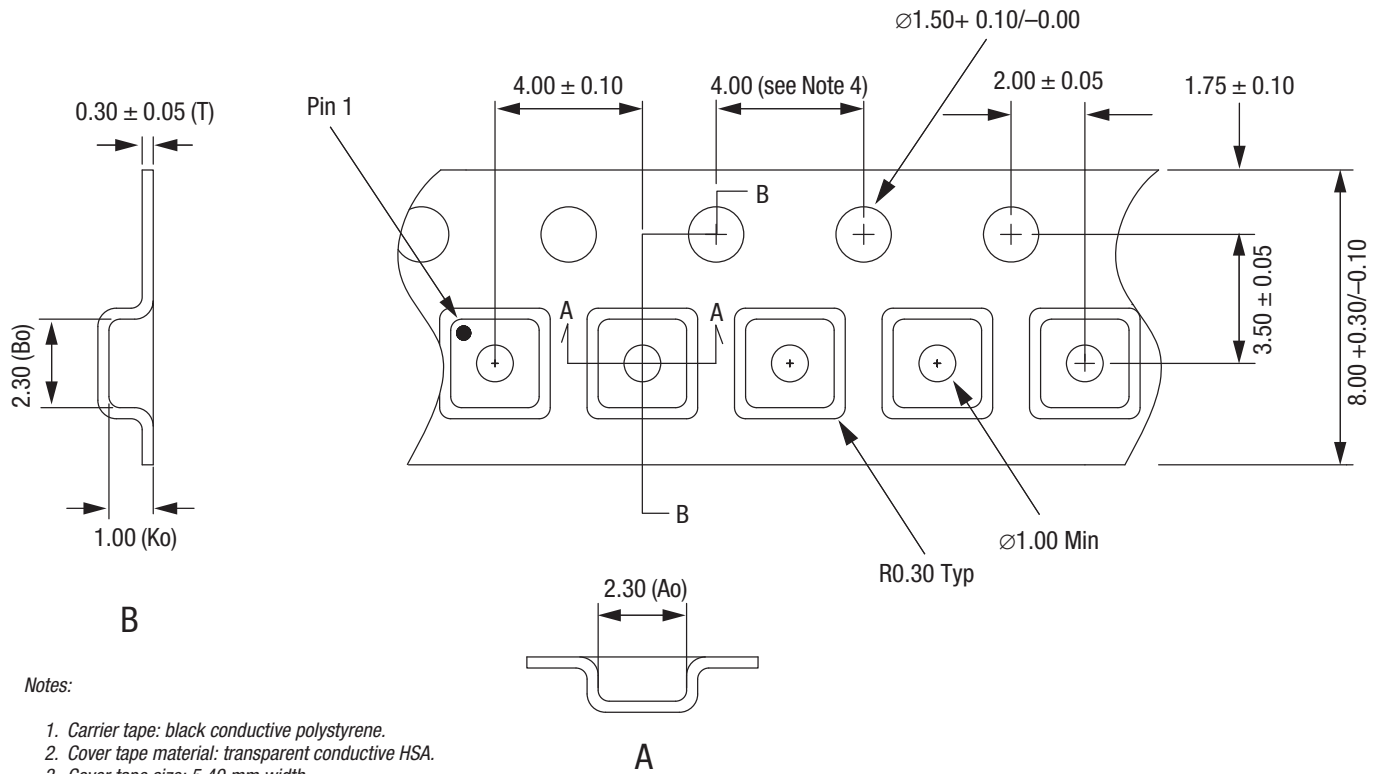

Notes:

1. Carrier tape: black conductive polystyrene.
2. Cover tape material: transparent conductive HSA.
3. Cover tape size: 5.40 mm width.
4. 10-sprocket hole pitch cumulative tolerance = ±0.20 mm.
5. ESD surface resistivity is $\leq 1 \times 10^8$ Ohms/square per EIA, JEDEC tape and reel specification.
6. Ao and Bo measurement point to be 0.30 mm from bottom of pocket.
7. All measurements are in millimeters.

202922-028

Figure 28. SKY67150-396LF Tape and Reel Dimensions

Ordering Information

Model Name	Manufacturing Part Number	Evaluation Board Part Number
SKY67150-396LF LNA	SKY67150-396LF	SKY67150-396EK1 (380 to 530 MHz) SKY67150-396EK2 (650 to 1100 MHz) SKY67150-396EK3 (1400 to 2200 MHz)

Copyright © 2013-2014, 2016-2017 Skyworks Solutions, Inc. All Rights Reserved.

Information in this document is provided in connection with Skyworks Solutions, Inc. ("Skyworks") products or services. These materials, including the information contained herein, are provided by Skyworks as a service to its customers and may be used for informational purposes only by the customer. Skyworks assumes no responsibility for errors or omissions in these materials or the information contained herein. Skyworks may change its documentation, products, services, specifications or product descriptions at any time, without notice. Skyworks makes no commitment to update the materials or information and shall have no responsibility whatsoever for conflicts, incompatibilities, or other difficulties arising from any future changes.

No license, whether express, implied, by estoppel or otherwise, is granted to any intellectual property rights by this document. Skyworks assumes no liability for any materials, products or information provided hereunder, including the sale, distribution, reproduction or use of Skyworks products, information or materials, except as may be provided in Skyworks Terms and Conditions of Sale.

THE MATERIALS, PRODUCTS AND INFORMATION ARE PROVIDED "AS IS" WITHOUT WARRANTY OF ANY KIND, WHETHER EXPRESS, IMPLIED, STATUTORY, OR OTHERWISE, INCLUDING FITNESS FOR A PARTICULAR PURPOSE OR USE, MERCHANTABILITY, PERFORMANCE, QUALITY OR NON-INFRINGEMENT OF ANY INTELLECTUAL PROPERTY RIGHT; ALL SUCH WARRANTIES ARE HEREBY EXPRESSLY DISCLAIMED. SKYWORKS DOES NOT WARRANT THE ACCURACY OR COMPLETENESS OF THE INFORMATION, TEXT, GRAPHICS OR OTHER ITEMS CONTAINED WITHIN THESE MATERIALS. SKYWORKS SHALL NOT BE LIABLE FOR ANY DAMAGES, INCLUDING BUT NOT LIMITED TO ANY SPECIAL, INDIRECT, INCIDENTAL, STATUTORY, OR CONSEQUENTIAL DAMAGES, INCLUDING WITHOUT LIMITATION, LOST REVENUES OR LOST PROFITS THAT MAY RESULT FROM THE USE OF THE MATERIALS OR INFORMATION, WHETHER OR NOT THE RECIPIENT OF MATERIALS HAS BEEN ADVISED OF THE POSSIBILITY OF SUCH DAMAGE.

Skyworks products are not intended for use in medical, lifesaving or life-sustaining applications, or other equipment in which the failure of the Skyworks products could lead to personal injury, death, physical or environmental damage. Skyworks customers using or selling Skyworks products for use in such applications do so at their own risk and agree to fully indemnify Skyworks for any damages resulting from such improper use or sale.

Customers are responsible for their products and applications using Skyworks products, which may deviate from published specifications as a result of design defects, errors, or operation of products outside of published parameters or design specifications. Customers should include design and operating safeguards to minimize these and other risks. Skyworks assumes no liability for applications assistance, customer product design, or damage to any equipment resulting from the use of Skyworks products outside of stated published specifications or parameters.

Skyworks and the Skyworks symbol are trademarks or registered trademarks of Skyworks Solutions, Inc., in the United States and other countries. Third-party brands and names are for identification purposes only, and are the property of their respective owners. Additional information, including relevant terms and conditions, posted at www.skyworksinc.com, are incorporated by reference.