



Chipsmall Limited consists of a professional team with an average of over 10 year of expertise in the distribution of electronic components. Based in Hongkong, we have already established firm and mutual-benefit business relationships with customers from,Europe,America and south Asia,supplying obsolete and hard-to-find components to meet their specific needs.

With the principle of “Quality Parts,Customers Priority,Honest Operation,and Considerate Service”,our business mainly focus on the distribution of electronic components. Line cards we deal with include Microchip,ALPS,ROHM,Xilinx,Pulse,ON,Everlight and Freescale. Main products comprise IC,Modules,Potentiometer,IC Socket,Relay,Connector.Our parts cover such applications as commercial,industrial, and automotives areas.

We are looking forward to setting up business relationship with you and hope to provide you with the best service and solution. Let us make a better world for our industry!



## Contact us

Tel: +86-755-8981 8866 Fax: +86-755-8427 6832

Email & Skype: info@chipsmall.com Web: www.chipsmall.com

Address: A1208, Overseas Decoration Building, #122 Zhenhua RD., Futian, Shenzhen, China



# S-LINK

Related Information ■ General terms and conditions..... F-17

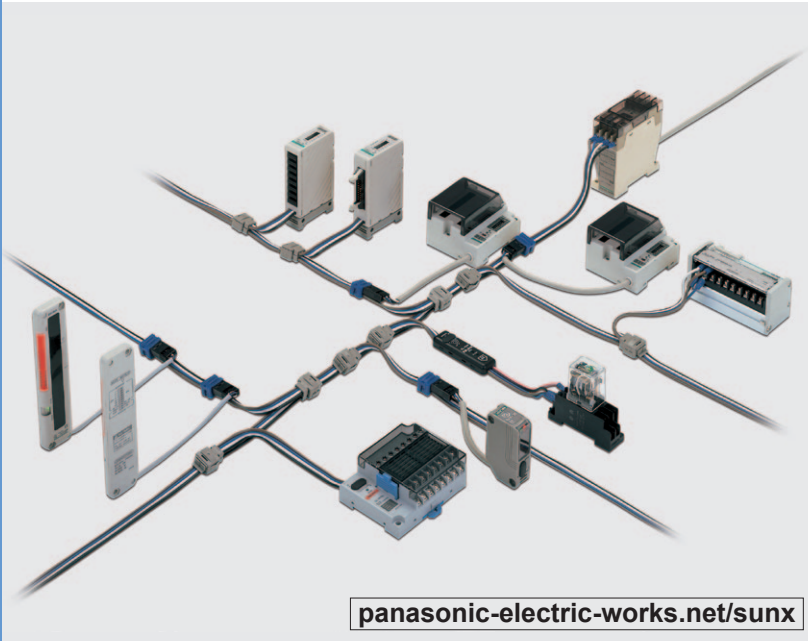

This product is introduced to only limited countries. Please contact our office for details.

**S-LINK transmits 128 points on two signal lines, and “T”-branch multi-drop system enabling flexible cable layout**

**We've realized a wire-saving system that's easy to use**

### Remote I/O

Just with the wire-saving between the PLC and the sub-stations, you'll be able to save a mountain of I/O device connection wires.



The remote I/O is one-dimensional wiring

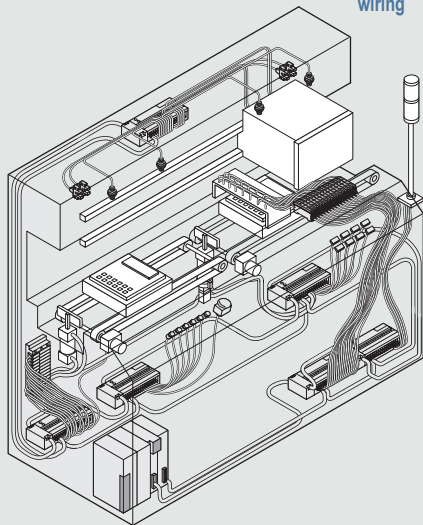

### S-LINK

Allows for great wire-saving for all connections. Installation is made easy with no faulty wiring. The power supply line can also be wired up together enabling true wire-saving for I/O devices.



The S-LINK is two-dimensional wiring

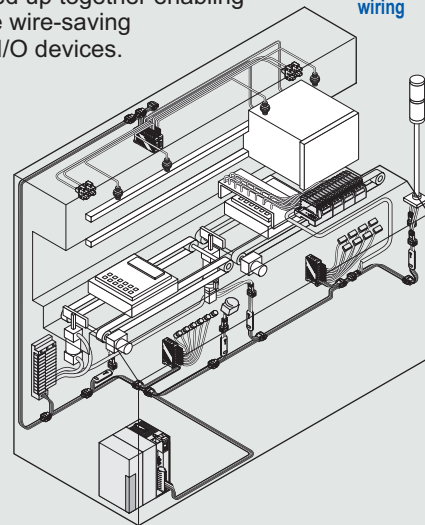

Transmission distance:  
 200 m **656.168 ft** (400 m **1312.336 ft** when using booster)  
 Total wiring length:  
 400 m **1312.336 ft** (800 m **2624.672 ft** when using one booster)  
 Connectable I/O: 128 points  
 (The maximum number of sub-stations which can be connected: 128 nodes)

- FIBER SENSORS
- LASER SENSORS
- PHOTOELECTRIC SENSORS
- MICRO PHOTOELECTRIC SENSORS
- AREA SENSORS
- LIGHT CURTAINS
- PRESSURE / FLOW SENSORS
- INDUCTIVE PROXIMITY SENSORS
- PARTICULAR USE SENSORS
- SENSOR OPTIONS
- SIMPLE WIRE-SAVING UNITS
- WIRE-SAVING SYSTEMS
- MEASUREMENT SENSORS
- STATIC CONTROL DEVICES
- ENDOSCOPE
- LASER MARKERS
- PLC / TERMINALS
- HUMAN MACHINE INTERFACES
- ENERGY CONSUMPTION VISUALIZATION COMPONENTS
- FA COMPONENTS
- MACHINE VISION SYSTEMS
- UV CURING SYSTEMS

For Large Scale Systems  
 For Medium Scale Systems

**S-LINK**

### High noise immunity

Large voltage amplitude (24 V) and wide pulse width (35  $\mu$ s) signal transmissions make for units less prone to impulse noise effects with no code errors. This high level of noise proofing enables them to be used even in worksites with conventional, high-priced optical communication remote I/O units.

### Specifies malfunctioning S-LINK I/O devices

In the event that verification cannot be obtained from an **S-LINK** I/O unit, such as if the main cable is cutoff, the address of the particular unverifiable **S-LINK** I/O unit is specified and displayed allowing equipment recovery time to be greatly reduced.



### Alleviates the burden laid on engineer for designing and wiring

Labor-saving hook-up connectors are used enabling multiple "T"-branch hookups. It goes without saying that cascade wiring (bus wiring) as well as multiple branch wiring (star wiring) is also possible.

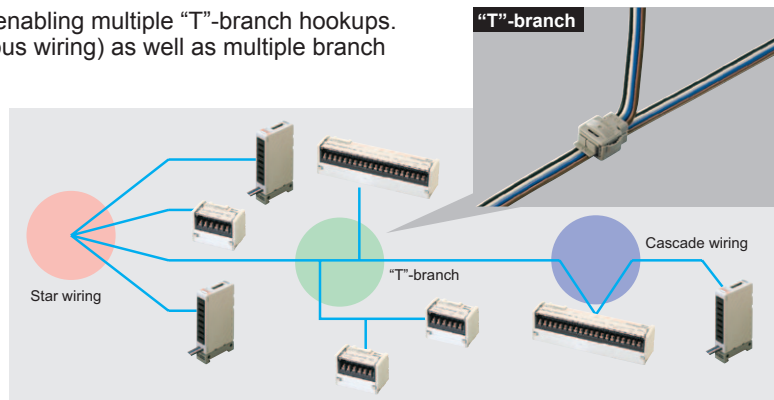

### Simple and reliable connections

We've provided all types of hook-up connectors. Connections from **S-LINK** I/O devices to the main cable and from sensors and other devices to **S-LINK** I/O devices are all realized with one-touch hook-up connectors. They can be connected anywhere quickly and maintenance is easy.

Branch cable to main cable connection and S-LINK I/O device to main cable connection

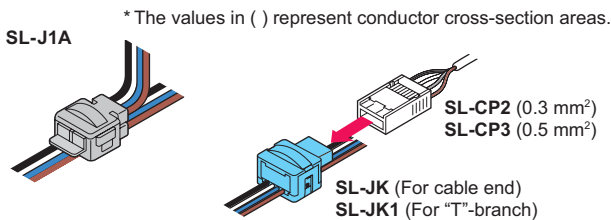

Connection from various connected units to S-LINK I/O devices

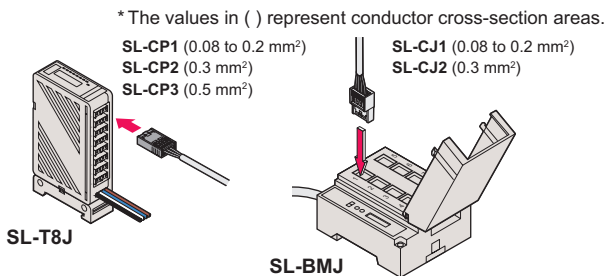

In addition, to enhance the reliability of the crimping, **S-LINK** exclusive pliers are made available so that anyone can do it with ease.

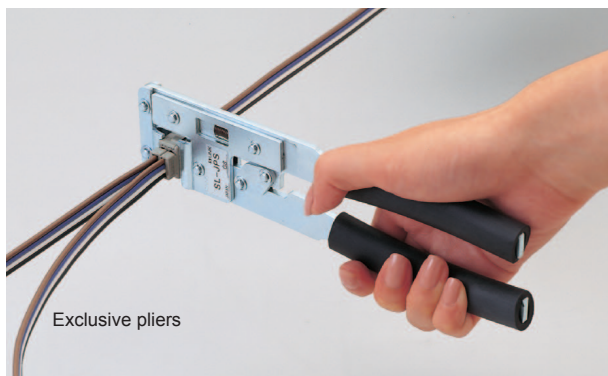

Connected device extensions

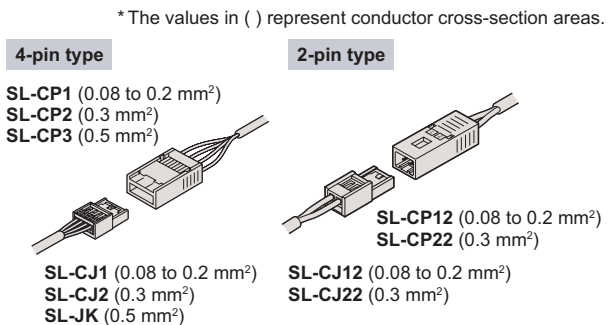

- FIBER SENSORS
- LASER SENSORS
- PHOTOELECTRIC SENSORS
- MICRO PHOTOELECTRIC SENSORS
- AREA SENSORS
- LIGHT CURTAINS
- PRESSURE / FLOW SENSORS
- INDUCTIVE PROXIMITY SENSORS
- PARTICULAR USE SENSORS
- SENSOR OPTIONS
- SIMPLE WIRE-SAVING UNITS
- WIRE-SAVING SYSTEMS
- MEASUREMENT SENSORS
- STATIC CONTROL DEVICES
- ENDOSCOPE
- LASER MARKERS
- PLC / TERMINALS
- HUMAN MACHINE INTERFACES
- ENERGY CONSUMPTION VISUALIZATION COMPONENTS
- FA COMPONENTS
- MACHINE VISION SYSTEMS
- UV CURING SYSTEMS

For Large Scale Systems  
For Medium Scale Systems

**S-LINK**

- FIBER SENSORS
- LASER SENSORS
- PHOTOELECTRIC SENSORS
- MICRO PHOTOELECTRIC SENSORS
- AREA SENSORS
- LIGHT CURTAINS
- PRESSURE / FLOW SENSORS
- INDUCTIVE PROXIMITY SENSORS
- PARTICULAR USE SENSORS
- SENSOR OPTIONS
- SIMPLE WIRE-SAVING UNITS
- WIRE-SAVING SYSTEMS**
- MEASUREMENT SENSORS
- STATIC CONTROL DEVICES
- ENDOSCOPE
- LASER MARKERS
- PLC / TERMINALS
- HUMAN MACHINE INTERFACES
- ENERGY CONSUMPTION VISUALIZATION COMPONENTS
- FA COMPONENTS
- MACHINE VISION SYSTEMS
- UV CURING SYSTEMS
- For Large Scale Systems
- For Medium Scale Systems
- S-LINK**

## Direct main cable connecting of sensors and actuators possible

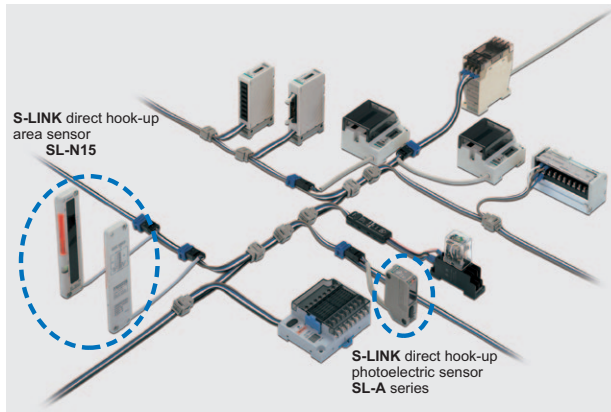

All types of transmission line direct-connecting type sensors are made available. Even partner makers are putting on the market manifold electromagnetic valves and limit switches that can be directly connected with the **S-LINK** system making wire-saving and labor-saving a reality.

### Items offered by partner makers

Manifold electromagnetic valve manufactured by Koganei Corp.



Manifold electromagnetic valve manufactured by SMC Pneumatics



Manifold electromagnetic valve manufactured by CKD Corp.



Component indicator lamp manufactured by Yazaki Industrial Chemical Co., Ltd.



## Mid-system main / branch cable installation and removal possible

For conveyors or other large scale equipment, transport can also be done after dividing the whole into units of several meters in length right at the factory. Then, reassembly and wiring can be effectuated onsite afterwards. Because the **S-LINK** can be easily divided even from mid-system main / branch cables with the help of commercially available connectors and terminals, the segmented equipment can be wired up prior to transport. Once onsite, assembly work is all but complete with just the connecting of the individual units to each other.

In addition, when assembling the equipment, the **S-LINK** can work even disconnected from the PLC enabling software (PLC programming) and hardware (machine assembly, I/O check) work to be done concurrently, which results in quick delivery time. With the handy monitor, I/O devices can be checked for each piece of equipment separately enabling subcontractors to conduct check work on delivery. This results in a total delivery deadline reduction and clearly defined subcontractor responsibilities. Also, checking can be performed even without programming so you'll know immediately if malfunctions are coming from the PLC or the **S-LINK**.

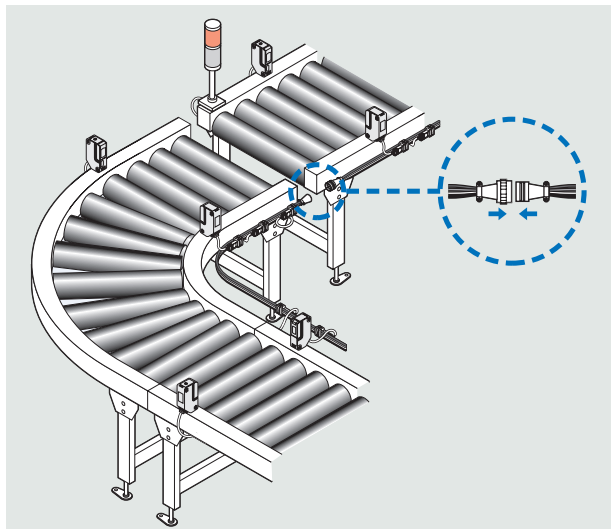

## Dividing equipment into subunits possible

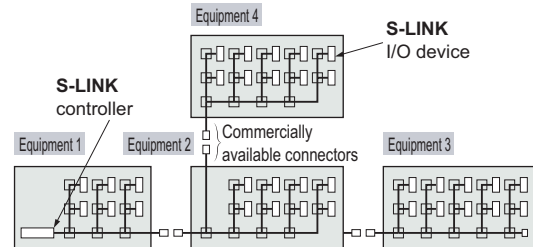

## Individual equipment subunits can be checked separately

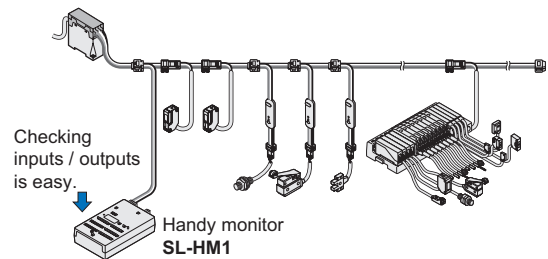

### Total cost reductions and great savings in setup time

By introducing the **S-LINK**, you can reduce the total cost of system construction to one-fifth. Total costs including for materials go down dramatically and, by decreasing the workload, construction time is lessened which means you can easily meet that tough deadline.

The **S-LINK** system:

- A hardware-only construction makes layout design simple
- With hook-up connectors, construction time is greatly reduced
- Layout modifications made easy
- Equipment divided into separate segments make for easy debugging
- Segmented equipment can be easily interlinked with commercially available connectors

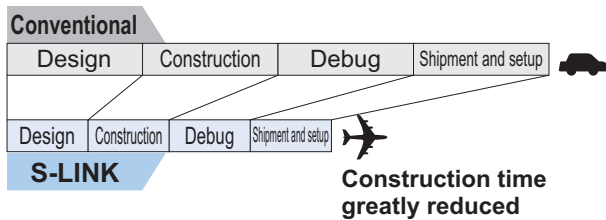

### Auxiliary materials reduced

Great reductions in auxiliary materials such as cable racks, cable ducts, intermediate terminal blocks, and cables. This system also contributes greatly to the reduction waste caused by cutting cable ends.

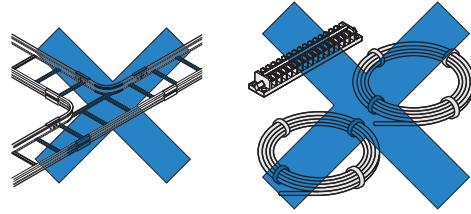

### Space-saving

Because of great reductions in the amount of intermediate terminal blocks and cables needed, you can save space and minimize the size of your control board and machines. This will finally let you put all that wasted space to good use.

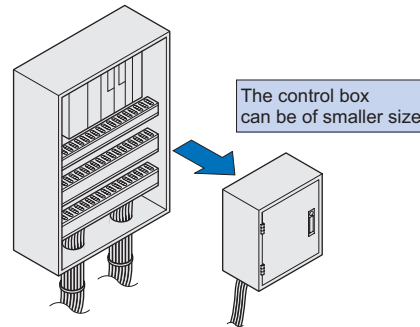

### Upper-level network connection possible

Because it can be connected to any main open network, long-distance and multi-point transmission networks can be constructed enabling a greatly enhanced network upgrade. Also, by wiring up scattered bit-oriented I/O devices that include mostly connected sensors and switches, an efficient wire-saving layout can be realized. If exporting equipment that was setup with any open network, it can be made to correspond to different networks just by installing an **S-LINK** gateway controller with the entire **S-LINK** system left as it is.

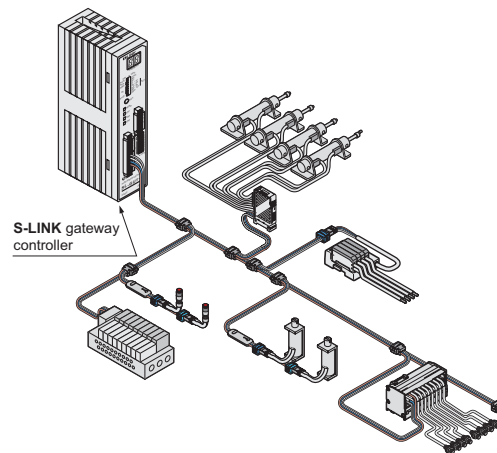

FIBER SENSORS

LASER SENSORS

PHOTOELECTRIC SENSORS

MICRO PHOTOELECTRIC SENSORS

AREA SENSORS

LIGHT CURTAINS

PRESSURE / FLOW SENSORS

INDUCTIVE PROXIMITY SENSORS

PARTICULAR USE SENSORS

SENSOR OPTIONS

SIMPLE WIRE-SAVING UNITS

WIRE-SAVING SYSTEMS

MEASUREMENT SENSORS

STATIC CONTROL DEVICES

ENDOSCOPE

LASER MARKERS

PLC / TERMINALS

HUMAN MACHINE INTERFACES

ENERGY CONSUMPTION VISUALIZATION COMPONENTS

FA COMPONENTS

MACHINE VISION SYSTEMS

UV CURING SYSTEMS

For Large Scale Systems

For Medium Scale Systems

**S-LINK**

- FIBER SENSORS
- LASER SENSORS
- PHOTOELECTRIC SENSORS
- MICRO PHOTOELECTRIC SENSORS
- AREA SENSORS
- LIGHT CURTAINS
- PRESSURE / FLOW SENSORS
- INDUCTIVE PROXIMITY SENSORS
- PARTICULAR USE SENSORS
- SENSOR OPTIONS
- SIMPLE WIRE-SAVING UNITS
- WIRE-SAVING SYSTEMS
- MEASUREMENT SENSORS
- STATIC CONTROL DEVICES
- ENDOSCOPE
- LASER MARKERS
- PLC / TERMINALS
- HUMAN MACHINE INTERFACES
- ENERGY CONSUMPTION VISUALIZATION COMPONENTS
- FA COMPONENTS
- MACHINE VISION SYSTEMS
- UV CURING SYSTEMS
- For Large Scale Systems
- For Medium Scale Systems

**APPLICATIONS**

**Distributed installation**

**Automatic storage**

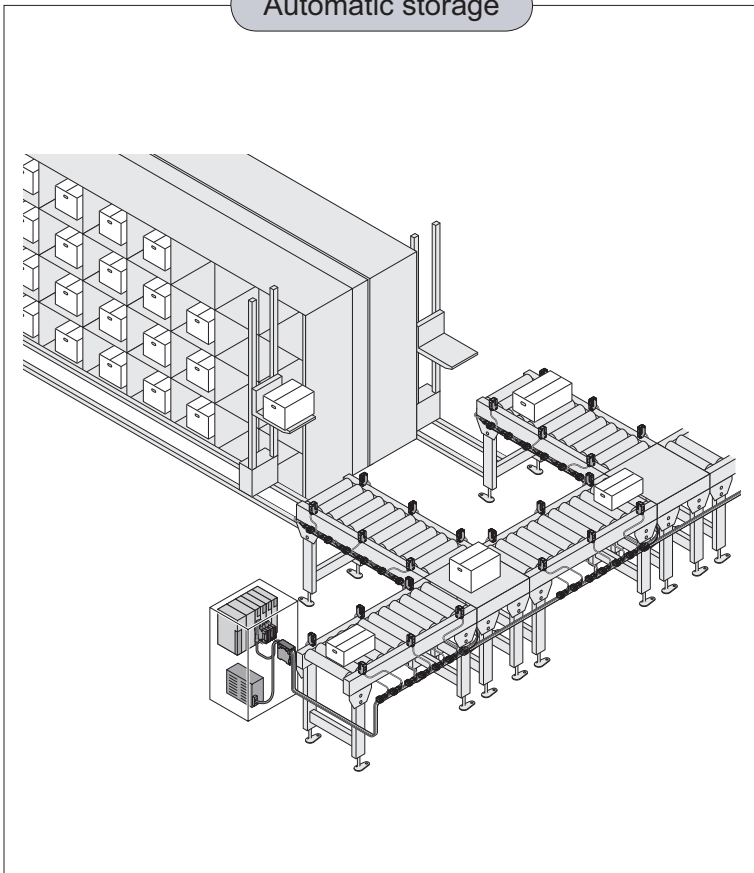

Because conveyors have multiple I/O device points, wire-saving and construction efficiency are the key to lowering overall costs. Other systems may be wire-saving but if they can't prove useful for long-distance distribution lines and be reliable, then they are useless. On this point, the **S-LINK** system offers a total wiring length of 400 m **1312 ft**, 800 m **2625 ft** when using booster, with reliable T-branch I/O device connections that can be mounted in any desired location.

Because T-branching renders layout designing simple, not only is it a wire-saving and construction efficient system, but you can even save time in the actual design stage. In addition, you can divide main and branch cables in mid-system with commercially available connectors and terminals so the time it takes to setup your conveyor decreases greatly.

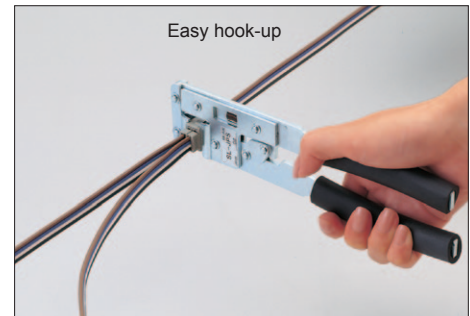

**Parking garage**

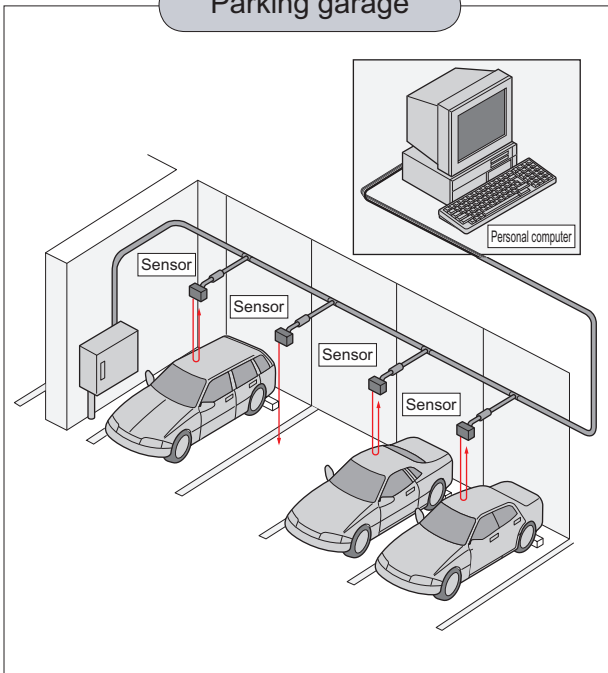

The **S-LINK** system is very suitable to wire up car detection sensors in a large parking garage. It reduces wires and installation time.

**Display panel control**

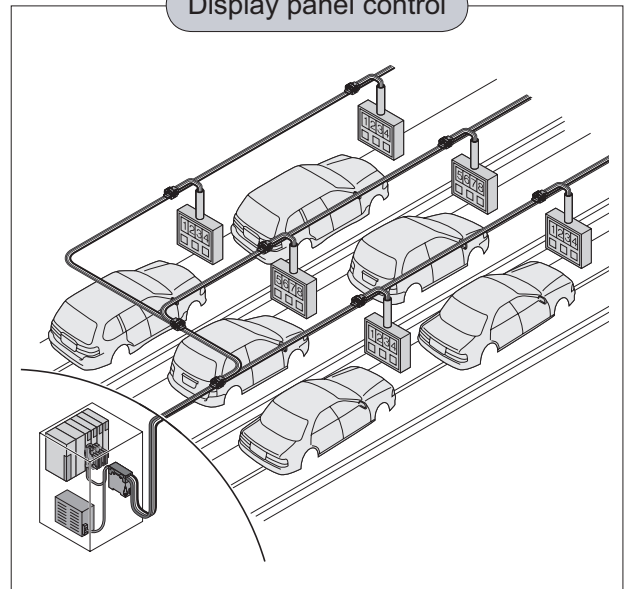

Display equipment can be mounted in automobile production lines to notify operators when malfunctions occur or just to keep a reliable count of units in each line.

Because each type of display equipment shows variegated data, they necessitate a great amount of wiring. This wiring must be conducted in very large factories requiring a substantial amount of cables and wires. A wire-saving system in this situation would be most effective.

Using the **S-LINK** system means that even display equipment can be wired up with just one flat cable, and clearing up all the bulky wiring inside the display panels themselves and realizing great material cost savings as well as a reduced workload.

**APPLICATIONS****Integrated installation**

Automatic assembly machine

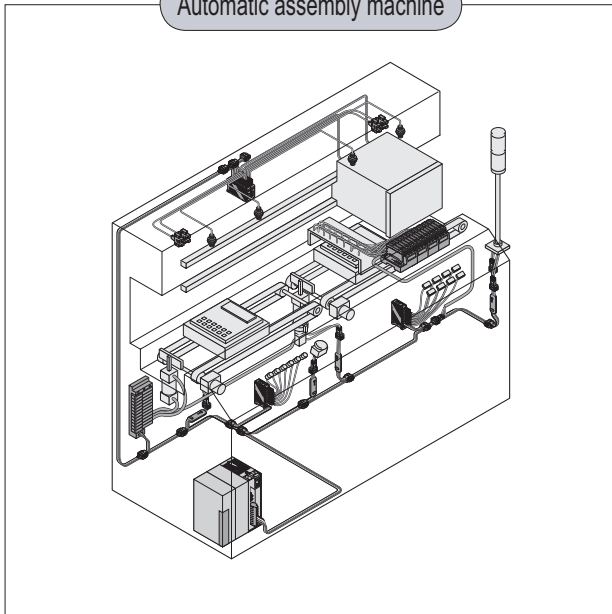

The wire-saving system is being greatly emphasized even for assembly lines crowded with multiple I/O devices. Also, to enhance productivity, using a wire-saving system is the key to reliability and avoiding the occurrence of troubles. In the **S-LINK** loop wiring, the system maintains signal transmission even when the loop may break at any one place. Also, the controller displays disconnected unit address. Further, when excess current flows or short-circuit occurs in the signal transmission lines, the signal transmission is stopped to protect the system. **S-LINK** is a wire-saving system optimal for the automatic assembly machinery.

Turntable

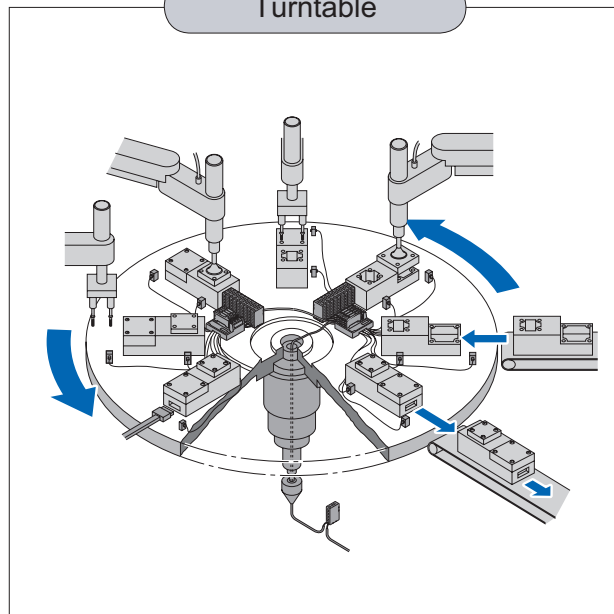

The wiring of I/O devices mounted on a rotating board (turntable) used to be quite a difficult task. Because a slip ring with the same number of terminals as wires had to be used. Therefore, there have been difficulties such as employing a large slip ring or reduction of I/O point count. **S-LINK** enables the connection of up to 128 I/O points on a 4-pole slip ring. A compact slip ring can be used without worrying about I/O points.

Handler

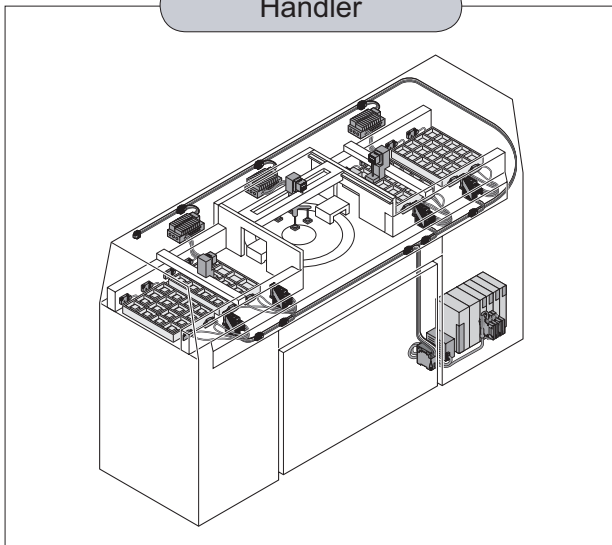

"The handler" as the IC test equipment uses multiple sensors. Cost reduction or downsizing depends on how to reduce these wires and to save space. **S-LINK** realizes wire-saving and space-saving; hence these problems are solved all at once.

Parts picking system

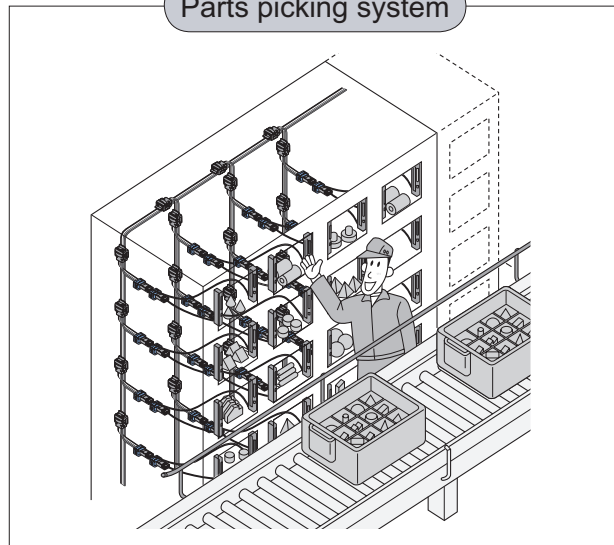

Many small picking sensors are employed in the parts picking system in order to verify the correct selection of components. The number of input points is required as much as the number of shelves, the number of output points is also required to be the same in adopting the operational indicators. **S-LINK** system greatly contributes to wire-saving both in I/O points and in space. Also, extra shelves can be added easily.

FIBER  
SENSORSLASER  
SENSORSPHOTOELECTRIC  
SENSORSMICRO  
PHOTOELECTRIC  
SENSORSAREA  
SENSORSLIGHT  
CURTAINSPRESSURE /  
FLOW  
SENSORSINDUCTIVE  
PROXIMITY  
SENSORSPARTICULAR  
USE SENSORSSENSOR  
OPTIONSSIMPLE  
WIRE-SAVING  
UNITS**WIRE-SAVING  
SYSTEMS**MEASUREMENT  
SENSORSSTATIC CONTROL  
DEVICES

ENDOSCOPE

LASER  
MARKERSPLC /  
TERMINALSHUMAN MACHINE  
INTERFACESENERGY CONSUMPTION  
VISUALIZATION  
COMPONENTS

FA COMPONENTS

MACHINE VISION  
SYSTEMSUV CURING  
SYSTEMSFor Large  
Scale SystemsFor Medium  
Scale Systems**S-LINK**

**SYSTEM LAYOUT**

**Upper-level control devices**

**PLC**

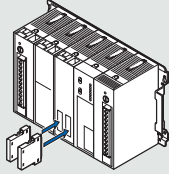

PLC I/O connectors  
(for connectable PLC)  
**SL-S□, SL-P□**



CE

Multi-core cable PLC I/O units  
(for screw-on terminal type PLC)  
**SL-S, SL-SP, SL-P, SL-PP**

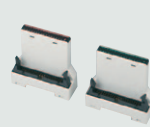

CE

**S-LINK controller  
SL-CU1A**



CE

**Booster  
SL-BS1A**



CE

**PLC  
(Direct connection to PLC bus)**

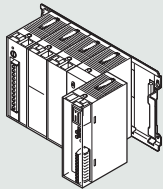

**S-LINK controller for direct connection to PLC bus / S-LINK control boards**

**FPΣ  
S-LINK unit  
FPG-SL**



**FP0 S-LINK  
Control unit  
FP0-SL1**



**FP2SH  
S-LINK unit  
FP2-SL2**



For Mitsubishi Electric Corp.  
PLC MELSEC-Q series  
**SL-MEL-Q**



CE

For Yokogawa Electric Corp.  
PLC FA-M3 series  
**SL-FAM3**



CE

**Items offered by partner makers**

Controllers manufactured by  
JTEKT Corp.  
**THU-5291**



**Personal computers**

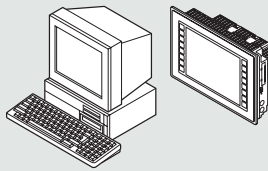

For ISA bus **SL-PCAT**



CE

For PC/104 bus **SL-PC104**



CE

**Open network  
compatible PLC**

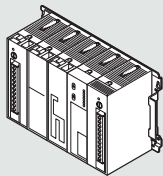

For CC-Link  
**SL-GU1-C**



CE

CC-Link

For Device Net  
**SL-GU1-D**



CE

DeviceNet.

FIBER SENSORS

LASER SENSORS

PHOTOELECTRIC SENSORS

MICRO PHOTOELECTRIC SENSORS

AREA SENSORS

LIGHT CURTAINS

PRESSURE / FLOW SENSORS

INDUCTIVE PROXIMITY SENSORS

PARTICULAR USE SENSORS

SENSOR OPTIONS

SIMPLE WIRE-SAVING UNITS

WIRE-SAVING SYSTEMS

MEASUREMENT SENSORS

STATIC CONTROL DEVICES

ENDOSCOPE

LASER MARKERS

PLC / TERMINALS

HUMAN MACHINE INTERFACES

ENERGY CONSUMPTION VISUALIZATION COMPONENTS

FA COMPONENTS

MACHINE VISION SYSTEMS

UV CURING SYSTEMS

For Large Scale Systems  
For Medium Scale Systems

S-LINK



**SYSTEM LAYOUT**

**S-LINK I/O devices**

Analog I/O arrayed terminal unit  
**SL-TBAD4, SL-TBDA1**



CE 4 inputs  
1 output

1 • 2 channel I/O unit  
**SL-CH□(-PN)**



CE

8 channel snap-connector I/O unit  
**SL-T8J(-PN), SL-TP8J(-PN)**



CE

For e-con 8 channel snap-connector I/O unit  
**SL-T8E(-PN), SL-TP8E(-PN)**



CE

16 channel MIL connector I/O unit  
**SL-T16C1(-PN), SL-TP16C1(-PN)**

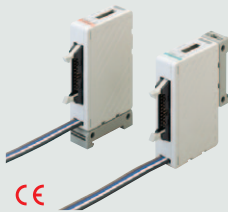

CE

8-branch connector tap  
**SL-T8PW**



CE

I/O arrayed terminal unit  
**SL-TB□(-PN), SL-TBP□(-PN)  
SL-TBP□-TY**



CE 4, 8 or 16 inputs  
4, 8 or 16 outputs

Relay output terminal unit  
**SL-TPR4, SL-TPR8**

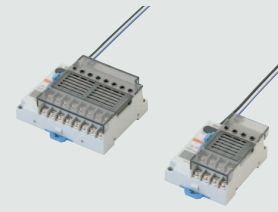

Snap-connector sensor block  
**SL-BMJ, SL-BXJ**



Plug-in unit sensor block  
**SL-BM, SL-BX**



CE

**S-LINK** direct hook-up  
photoelectric sensor  
**SL-A□**



**S-LINK** direct hook-up  
picking sensor  
**SL-N15**



CE

**Items offered by partner makers**

Manifold electromagnetic valve  
manufactured by Koganei Corp.

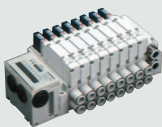

Manifold electromagnetic valve  
manufactured by SMC Pneumatics



Manifold electromagnetic valve  
manufactured by CKD Corp.



Component indicator lamp  
manufactured by Yazaki  
Industrial Chemical Co., Ltd.



FIBER  
SENSORS

LASER  
SENSORS

PHOTOELECTRIC  
SENSORS

MICRO  
PHOTOELECTRIC  
SENSORS

AREA  
SENSORS

LIGHT  
CURTAINS

PRESSURE /  
FLOW  
SENSORS

INDUCTIVE  
PROXIMITY  
SENSORS

PARTICULAR  
USE SENSORS

SENSOR  
OPTIONS

SIMPLE  
WIRE-SAVING  
UNITS

WIRE-SAVING  
SYSTEMS

MEASUREMENT  
SENSORS

STATIC CONTROL  
DEVICES

ENDOSCOPE

LASER  
MARKERS

PLC /  
TERMINALS

HUMAN MACHINE  
INTERFACES

ENERGY CONSUMPTION  
VISUALIZATION  
COMPONENTS

FA COMPONENTS

MACHINE VISION  
SYSTEMS

UV CURING  
SYSTEMS

For Large  
Scale Systems

For Medium  
Scale Systems

**S-LINK**

**Plug-in units (for SL-BM, SL-BX)**

Amplifier-separated  
photoelectric sensor  
**SU-7J**



CE

Input terminal unit  
**SL-TJ1**

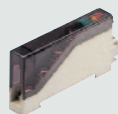

CE

**SYSTEM LAYOUT**

**Connectors and cables**

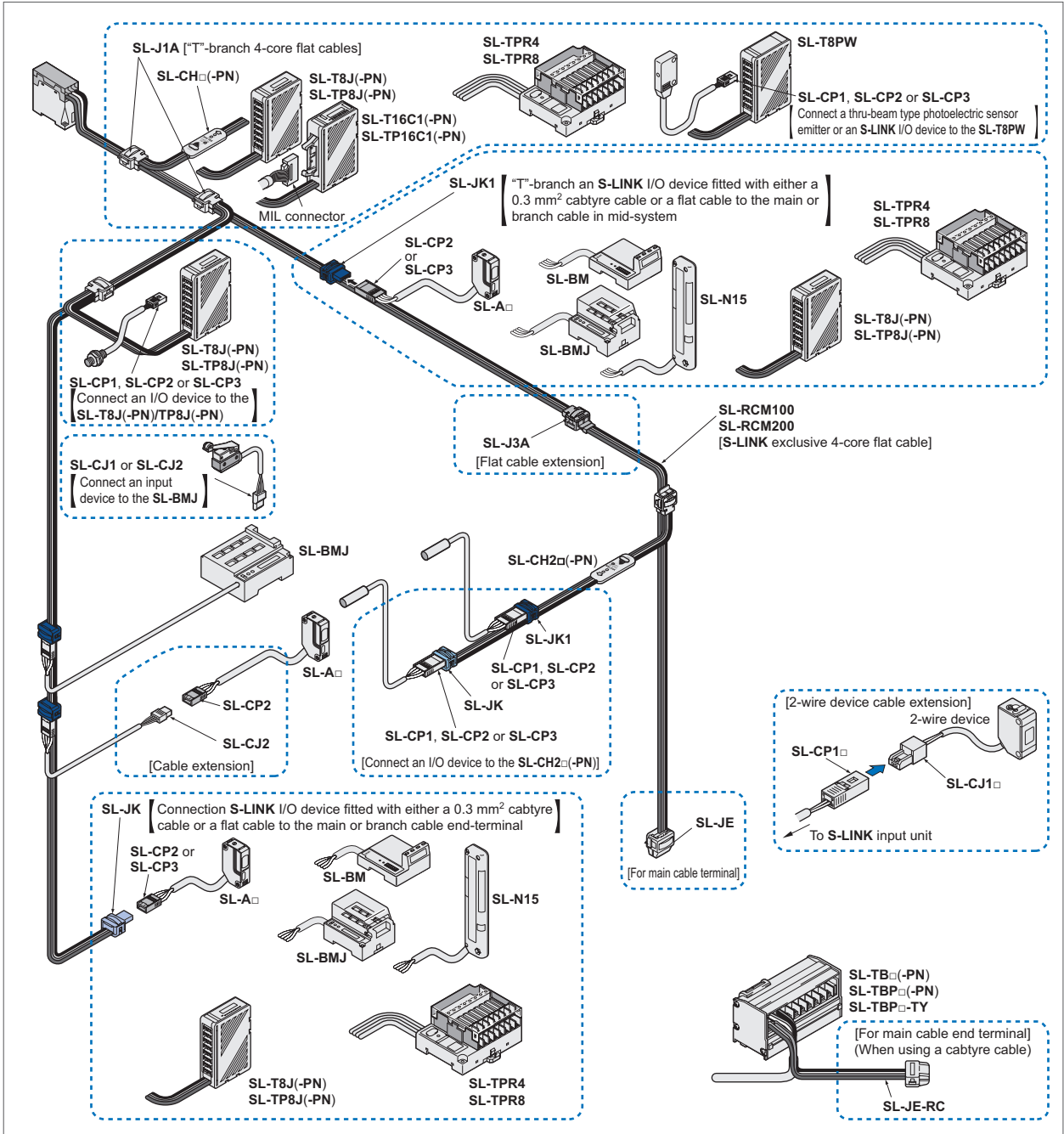

**Other S-LINK devices**









I/O modules  
**SL-M□, SL-M□F**  
 8 or 16 inputs  
 8 or 16 outputs  
 4 inputs and 4 outputs

Handy monitor  
**SL-HM1**



- FIBER SENSORS
- LASER SENSORS
- PHOTOELECTRIC SENSORS
- MICRO PHOTOELECTRIC SENSORS
- AREA SENSORS
- LIGHT CURTAINS
- PRESSURE / FLOW SENSORS
- INDUCTIVE PROXIMITY SENSORS
- PARTICULAR USE SENSORS
- SENSOR OPTIONS
- SIMPLE WIRE- SAVING UNITS
- WIRE- SAVING SYSTEMS
- MEASUREMENT SENSORS
- STATIC CONTROL DEVICES
- ENDOSCOPE
- LASER MARKERS
- PLC / TERMINALS
- HUMAN MACHINE INTERFACES
- ENERGY CONSUMPTION VISUALIZATION COMPONENTS
- FA COMPONENTS
- MACHINE VISION SYSTEMS
- UV CURING SYSTEMS
- For Large Scale Systems
- For Medium Scale Systems
- S-LINK**

**ORDER GUIDE****S-LINK control units**

Designation	Appearance (Note)	Model No.	Description
<b>S-LINK</b> controller	 CE	<b>SL-CU1A</b>	It supplies the synchronization signal to the complete system to send and receive I/O data from external devices correctly. It also monitors the signal transmission line, and specifies the addresses of the disconnected devices if the line breaks, etc.
<b>FPΣ</b> S-LINK unit		<b>FPG-SL</b> (AFP780)	It controls the <b>S-LINK</b> system by directly connecting to the <b>FPΣ</b> series.
<b>FP0</b> S-LINK Control unit		<b>FP0-SL1</b> (AFP02700)	It controls the <b>S-LINK</b> system by directly connecting to the <b>FP0</b> series.
<b>FP2SH</b> S-LINK unit		<b>FP2-SL2</b> (AFP2780)	It controls the <b>S-LINK</b> system by directly connecting to the <b>FP2SH</b> series.
Mitsubishi Electric PLC bus <b>S-LINK</b> controller	 CE	<b>SL-MEL-Q</b>	It can be directly connected to the bus line of the MELSEC-Q series PLC manufactured by Mitsubishi Electric Corp. ( Has <b>S-LINK</b> controller as well as PLC input and output connector functions so you don't have to prepare for these items. Also, it doesn't need a PLC input or output module. )
Yokogawa Electric PLC bus <b>S-LINK</b> controller	 CE	<b>SL-FAM3</b>	It can be directly connected to the bus line of the FA-M3 series PLC manufactured by Yokogawa Electric Corp. ( Has <b>S-LINK</b> controller as well as PLC input and output connector functions so you don't have to prepare for these items. Also, it doesn't need a PLC input or output module. )
PC/AT <b>S-LINK</b> control board	 CE	<b>SL-PCAT</b>	It can be fitted into the expansion slot (ISA bus) of PC/AT series or compatible to control the <b>S-LINK</b> system. ( Has <b>S-LINK</b> controller as well as PLC input and output connector functions so you don't have to prepare for these items. )
PC/104 bus <b>S-LINK</b> control board	 CE	<b>SL-PC104</b>	Controls the <b>S-LINK</b> system by directly coupling (stack) the PC/104 bus line to a PC/104 bus compatible PC board or panel computer. ( Has <b>S-LINK</b> controller as well as PLC input and output connector functions so you don't have to prepare for these items. )

Note: Components with "CE" mark conform to the CE marking EMC Directive.

The following condition must be met to conform to EN 61000-6-2.

• **Conditions**

- ① Cable length between the main power supply and the **S-LINK** control unit should be less than 10 m **32.808 ft**.
- ② When the power is supplied from **S-LINK** control unit to **S-LINK** I/O devices at a cable distance of more than 10 m **32.808 ft** add a surge absorber between 24 V and 0 V at a cable distance of less than 10 m **32.808 ft**, or use a local power supply at a cable distance of less than 10 m **32.808 ft** from each **S-LINK** I/O device.

FIBER SENSORS

LASER SENSORS

PHOTO-ELECTRIC SENSORS

MICRO PHOTO-ELECTRIC SENSORS

AREA SENSORS

LIGHT CURTAINS

PRESSURE / FLOW SENSORS

INDUCTIVE PROXIMITY SENSORS

PARTICULAR USE SENSORS

SENSOR OPTIONS

SIMPLE WIRE-SAVING UNITS

WIRE-SAVING SYSTEMS

MEASUREMENT SENSORS

STATIC CONTROL DEVICES

ENDOSCOPE

LASER MARKERS

PLC / TERMINALS

HUMAN MACHINE INTERFACES

ENERGY CONSUMPTION VISUALIZATION COMPONENTS

FA COMPONENTS

MACHINE VISION SYSTEMS

UV CURING SYSTEMS

For Large Scale Systems

For Medium Scale Systems

**S-LINK**

FIBER SENSORS

LASER SENSORS

PHOTO-ELECTRIC SENSORS

MICRO PHOTO-ELECTRIC SENSORS

AREA SENSORS

LIGHT CURTAINS

PRESSURE / FLOW SENSORS

INDUCTIVE PROXIMITY SENSORS

PARTICULAR USE SENSORS

SENSOR OPTIONS

SIMPLE WIRE-SAVING UNITS

WIRE-SAVING SYSTEMS

MEASUREMENT SENSORS

STATIC CONTROL DEVICES

ENDOSCOPE

LASER MARKERS

PLC / TERMINALS

HUMAN MACHINE INTERFACES

ENERGY CONSUMPTION VISUALIZATION COMPONENTS

FA COMPONENTS

MACHINE VISION SYSTEMS

UV CURING SYSTEMS



For Large Scale Systems

For Medium Scale Systems

**S-LINK**

**ORDER GUIDE**

**Products for open network**

Designation	Appearance (Note)	Model No.	Description
<b>S-LINK</b> gateway controller for CC-Link		<b>SL-GU1-C</b>	<b>S-LINK</b> gateway controller for connection to open network CC-Link, promoted by Mitsubishi Electric Corp.
<b>S-LINK</b> gateway controller for DeviceNet		<b>SL-GU1-D</b>	<b>S-LINK</b> gateway controller for connection to open network DeviceNet.

Note: Components with “**CE**” mark conform to the CE marking EMC Directive. The following condition must be met to conform to EN 61000-6-2.

• **Conditions**

- ① Cable length between the main power supply and the **S-LINK** control unit should be less than 10 m **32.808 ft**.
- ② When the power is supplied from **S-LINK** control unit to **S-LINK** I/O devices at a cable distance of more than 10 m **32.808 ft** add a surge absorber between 24 V and 0 V at a cable distance of less than 10 m **32.808 ft**, or use a local power supply at a cable distance of less than 10 m **32.808 ft** from each **S-LINK** I/O device.

**PLC related units**

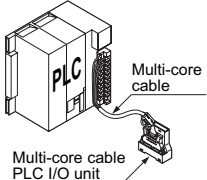
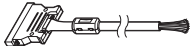
Designation	Appearance (Note 1)	Model No.		Description
		For input	For output	
Multi-core cable PLC I/O unit		<b>SL-S</b>	<b>SL-P</b>	This is the Multi-core cable PLC I/O unit for connecting the screw-on terminal type PLC with the <b>S-LINK</b> system. Interfaces I/O data between the <b>S-LINK</b> controller and PLC. It includes the I/O data conversion circuit for serial to parallel or parallel to serial conversion. I/O points: 32 points per unit. Connection to screw-on terminal type PLC is by an optional multi-core cable attached with an MIL connector on one end.
		<b>SL-SP</b>	<b>SL-PP</b>	
Multi-core cable		<b>SL-L2000F</b>		Length: 2 m <b>6.562 ft</b> The multi-core cable attached with an MIL connector on one end links the multi-core cable PLC I/O unit to a screw-on terminal type PLC I/O module.

- Notes: 1) Components with “**CE**” mark conform to the CE marking EMC Directive. However, note that for the multi-core cable PLC I/O units to conform to CE marking EMC Directive, it is necessary to use cascade cable **SL-F70**, **SL-F150** or **SL-F250**, control cable **SL-C2000F** and multi-core cable **SL-L2000F**.
- 2) In case the output circuit of the PLC output module contains capacitive components for improving the noise characteristics, since it is possible that the multi-core cable PLC output units **SL-P**, **SL-PP** may not be able to receive the signal correctly, please use output modules which have an output circuit capacitance of 0.01 μF or less.
- 3) Since the multi-core cable PLC output units **SL-P**, **SL-PP** are high input impedance, time division input type devices, please use PLC output modules whose output circuit can operate at a load current of even 0.1 mA.

**ORDER GUIDE**

**PLC related units**

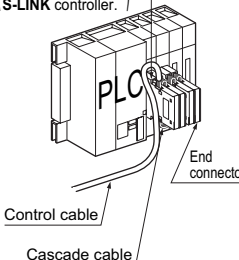
Designation	Appearance (Note 1)	Model No.		Description			
		For input	For output	Manufacturer	PLC	PLC input module (Note 4)	PLC output module (Note 4)
PLC input connector PLC output connector End connector Cascade cable Control cable	<p>Fujitsu Component connector specs. MIL connector specs.</p>  <p>PLC input connectors PLC output connectors (same shape) (Note 2)</p> <p>The listed PLC I/O modules (NPN I/O type) allow the mating PLC I/O connector to be plugged on them for signal transmission between the PLC and the <b>S-LINK</b> controller.</p> <p>(The PLC I/O connector converts I/O data from serial to parallel, and vice versa. I/O points: 32 points per connector)</p> <p>Max. four PLC I/O connectors can be cascaded with one <b>S-LINK</b> controller.</p> 	<b>SL-S1</b>	<b>SL-P1</b>	Panasonic Electric Works SUNX Co., Ltd. Toshiba Machine Co., Ltd.	FPΣ (Excluding the FPG-C32T) FP2 TC200	FPG-XY64D2T (X side) FPG-XY64D2T (Y side) FP2-X32D2 FP2-Y32T TC64DI TC64DON	FPG-XY64D2T (Y side) FP2-Y32T TC64DON
		<b>SL-S2</b>	<b>SL-P2</b>	Fuji Electric FA Components & Systems Co., Ltd.	NS series F55 F70	NS-X64-1 NS-XY64-1 (X side) NS-XY64-1 (Y side) NV1X3204 NV1X3204-W NV1X3206 NC1X3204 NC1X3204-3 NC1X3206 NC1X6404 NC1X6406 NC1W6406T (X side)	NS-Y64-T1 NS-XY64-1 (Y side) NV1Y32T05P1 NC1Y32T05P1 NC1Y64T05P1-1 NC1W6406T (Y side)
		<b>SL-S3</b>	<b>SL-P3</b>	Fuji Electric FA Components & Systems Co., Ltd. Mitsubishi Electric Corp.	SX series SPH AnS AnN, AnA AnU, QnA QnAs Q A2CJ	NP1X3206-W NP1X6406-W A1SX41 A1SX42 A1SH42 (X side) AX42 AH42 (X side) QX41, QX42 AJ35TC1-32D	NP1Y32T09P1 NP1Y64T09P1 A1SY41 A1SY42 A1SH42 (Y side) AY42 AH42 (Y side) QY41P, QY42P AJ35TC1-32T
		<b>SL-S4</b>	<b>SL-P4</b>	Sharp Manufacturing Systems Corp.	JW20, JW20H JW30H JW50H	JW-234N JW-264N JW-34NC JW-64NC	JW-232S JW-262S JW-32SC JW-62SC
		<b>SL-S5</b>	<b>SL-P5</b>	Omron Corp. Hitachi Ltd. Yokogawa Electric Corp. Toshiba Corp. Yasukawa Electric Corp.	CJ1 CS1 CVM1, CV C500 C1000H C2000H C200H series CQM1	CJ1W-ID231 CJ1W-ID261 CJ1W-MD261 (X side) CJ1W-MD261 (Y side) CS1W-ID231 CS1W-ID261 CS1W-MD261 (X side) CS1W-MD261 (Y side) C500-ID219 C200H-ID216 C200H-ID217 C200H-ID218 C200H-ID219 CQM1-ID213 CQM1-OD213 EH-XD32 XD64-6N WD64-6N (X side) YD64-1A WD64-6N (Y side) F3XD32-3N F3XD64-3N F3YD32-1A F3YD64-1A DI-335 DI-335H DO-335	CJ1W-OD231 CJ1W-OD261 CJ1W-MD261 (Y side) CS1W-OD231 CS1W-OD261 CS1W-MD261 (Y side) C500-OD213 C200H-OD218 C200H-OD219 CQM1-OD213 EH-YT32
		<b>SL-S6</b>	<b>SL-P6</b>	Hitachi Ltd.	H series	XDC24D2H	YTR24DH
		<b>SL-S7</b>	—	Yasukawa Electric Corp.	GL20, GL40S GL60S, GL60H GL70H	—	B2604
		<b>SL-E</b>	—	—	—	—	—
		<b>SL-F70</b>	—	—	—	Length: 70 mm <a href="#">2.756 in</a>	It links PLC input / PLC output connectors.
		<b>SL-F150</b>	—	—	—	Length: 150 mm <a href="#">5.906 in</a>	
		<b>SL-F250</b>	—	—	—	Length: 250 mm <a href="#">9.843 in</a>	
		<b>SL-F1000</b>	—	—	—	Length: 1,000 mm <a href="#">39.370 in</a>	
		<b>SL-C1000</b>	—	—	—	Length: 1 m <a href="#">3.281 ft</a>	It links the <b>S-LINK</b> controller and the first PLC I/O connector.
		<b>SL-C2000</b>	—	—	—	Length: 2 m <a href="#">6.562 ft</a>	
		<b>SL-C5000</b>	—	—	—	Length: 5 m <a href="#">16.404 ft</a>	
<b>SL-C2000F</b>	—	—	—	Length: 2 m <a href="#">6.562 ft</a>			









- Notes: 1) Components with “**CE**” mark conform to the CE marking EMC Directive.  
 However, note that for the PLC I/O connectors to conform to CE marking EMC Directive, it is necessary to use cascade cable **SL-F70**, **SL-F150** or **SL-F250** and control cable **SL-C2000F**.  
 2) The PLC I/O connectors use Fujitsu connectors. However, **SL-S1**, **SL-S6**, **SL-P1** and **SL-P6** connectors use MIL connectors.  
 3) PLC I/O connectors are connectable to **S-LINK** controller **SL-CU1A** only.  
 4) X side and Y side indicate the input and the output connectors, respectively, of the compound input / output module.

FIBER SENSORS  
 LASER SENSORS  
 PHOTO-ELECTRIC SENSORS  
 MICRO PHOTO-ELECTRIC SENSORS  
 AREA SENSORS  
 LIGHT CURTAINS  
 PRESSURE / FLOW SENSORS  
 INDUCTIVE PROXIMITY SENSORS  
 PARTICULAR USE SENSORS  
 SENSOR OPTIONS  
 SIMPLE WIRE-SAVING UNITS  
 WIRE-SAVING SYSTEMS  
 MEASUREMENT SENSORS  
 STATIC CONTROL DEVICES  
 ENDOSCOPE  
 LASER MARKERS  
 PLC / TERMINALS  
 HUMAN MACHINE INTERFACES  
 ENERGY CONSUMPTION VISUALIZATION COMPONENTS  
 FA COMPONENTS  
 MACHINE VISION SYSTEMS  
 UV CURING SYSTEMS  
 For Large Scale Systems  
 For Medium Scale Systems

**S-LINK**

**ORDER GUIDE**

**S-LINK I/O devices**

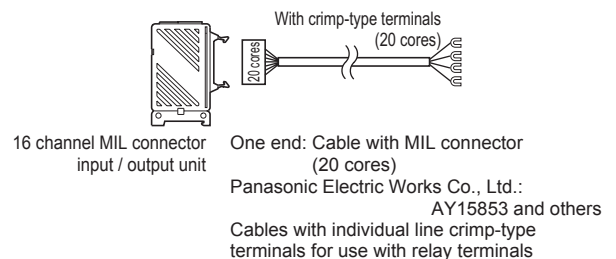
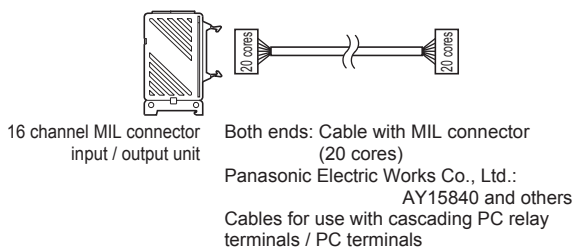

Designation	Appearance (Note 1)	Model No.	Description	
1 channel I/O unit		SL-CH1	NPN type	It can be used as either an input unit or an output unit by switch selection. Signals, such as from the sensor and limit switch, can be transmitted by the signal transmission line. These signals from the signal transmission line can turn ON / OFF the transistor output.
		SL-CH1-PN	PNP type	
2 channel I/O mixed unit		SL-CH21	NPN type	1 input and 1 output are equipped. 1 input device and 1 output device are connectable.
		SL-CH21-PN	PNP type	
2 channel input unit		SL-CH20	NPN type	2 input devices are connectable.
		SL-CH20-PN	PNP type	
2 channel output unit		SL-CH22	NPN type	2 output devices are connectable.
		SL-CH22-PN	PNP type	
Connector I/O unit		SL-T8J	8 NPN inputs	8 input or 8 output devices are connectable with snap male connectors. The output unit is incorporated with an output signal hold function, which retains the output state just prior to an error on the signal transmission line.
		SL-T8J-PN	8 PNP inputs	
		SL-TP8J	8 NPN outputs	
		SL-TP8J-PN	8 PNP outputs	
Connector I/O unit		SL-T16C1	16 NPN inputs	Since connection can be made with an MIL connector, 16 input or 16 output devices can be connected to this slim I/O unit. The output unit is incorporated with an output signal hold function, which retains the output state just prior to an error on the signal transmission line.
		SL-T16C1-PN	16 PNP inputs	
		SL-TP16C1	16 NPN outputs	
		SL-TP16C1-PN	16 PNP outputs	
Connector I/O unit		SL-T8E	8 NPN inputs	Up to 8 input or output devices can be easily connected via e-CON. Also, when there is an abnormality in the signal communication line, the output status just before the abnormality can be preserved since the output unit is equipped with an output hold function. *For the connector, please separately purchase a commercial product which supports e-CON standards.
		SL-T8E-PN	8 PNP inputs	
		SL-TP8E	8 NPN outputs	
		SL-TP8E-PN	8 PNP outputs	
Analog I/O arrayed terminal unit		SL-TBAD4	4 inputs	This is an analog input terminal unit which can connect 4 devices having an analog output. Since power supply terminals have been provided for each input channel, neat wiring is possible.
		SL-TBDA1	1 output	

Notes: 1) Components with "CE" mark conform to the CE marking EMC Directive.  
 2) It is convenient to use a MIL connector cable made by Panasonic Electric Works Co., Ltd. when connecting to a device. Connect the 20-core connector side to a 16 channel unit when using it. Contact our office for details.



16 channel MIL connector input / output unit give support for the Panasonic Electric Works Co., Ltd. MIL connector relay terminal pin arrangement. Contact our office for details.

**ORDER GUIDE****S-LINK I/O devices**

Designation		Appearance (Note 1)	Model No.	Description			
I/O arrayed terminal unit	Input terminal		<b>SL-TB4</b>	4 NPN inputs	They are screw-on terminal units to which 4, 8 or 16 input devices are connectable. Since power supply terminals have been provided for every two input channel, neat wiring is possible.		
			<b>SL-TB4-PN</b>	4 PNP inputs			
			<b>SL-TB8</b>	8 NPN inputs			
			<b>SL-TB8-PN</b>	8 PNP inputs			
			<b>SL-TB16</b>	16 NPN inputs			
			<b>SL-TB16-PN</b>	16 PNP inputs			
	Output terminal		<b>SL-TBP4</b>	4 NPN outputs	They are screw-on terminal units to which 4, 8 or 16 output devices are connectable. The output unit is incorporated with an output signal hold function, which retains the output state just prior to an error on the signal transmission line.		
			<b>SL-TBP4-PN</b>	4 PNP outputs			
			<b>SL-TBP8</b>	8 NPN outputs			
			<b>SL-TBP8-PN</b>	8 PNP outputs			
			<b>SL-TBP16</b>	16 NPN outputs			
			<b>SL-TBP16-PN</b>	16 PNP outputs			
			Separate load power supply type	<b>SL-TBP4-TY</b>		4 NPN outputs	In the case that a malfunction occurs to the output device that is being connected, they enable forced turning OFF of the output device connected to the output terminal without halting the complete <b>S-LINK</b> system, by switching off the load power supply.
				<b>SL-TBP8-TY</b>		8 NPN outputs	
<b>SL-TBP16-TY</b>	16 NPN outputs						
Relay output terminal unit	4 relay output		<b>SL-TPR4</b>	4 outputs (Note 2)	They are terminal units to which 4 or 8 output devices can be connected by slim socket relays that can be easily replaced. They are incorporated with an output signal hold function which retains the output state just prior to an error on the signal transmission line.		
	8 relay output		<b>SL-TPR8</b>	8 outputs (Note 2)			

Notes: 1) Components with “**CE**” mark conform to the CE marking EMC Directive.

2) Relay output is “Contact a” only. Further, when replacing the relay, use PA relay (APA3312) manufactured by Panasonic Electric Works Co., Ltd.









FIBER  
SENSORSLASER  
SENSORSPHOTO-  
ELECTRIC  
SENSORSMICRO  
PHOTO-  
ELECTRIC  
SENSORSAREA  
SENSORSLIGHT  
CURTAINSPRESSURE /  
FLOW  
SENSORSINDUCTIVE  
PROXIMITY  
SENSORSPARTICULAR  
USE  
SENSORSSENSOR  
OPTIONSSIMPLE  
WIRE-SAVING  
UNITSWIRE-SAVING  
SYSTEMSMEASURE-  
MENT  
SENSORSSTATIC  
CONTROL  
DEVICES

ENDOSCOPE

LASER  
MARKERSPLC /  
TERMINALSHUMAN  
MACHINE  
INTERFACESENERGY  
CONSUMPTION  
VISUALIZATION  
COMPONENTSFA  
COMPONENTSMACHINE  
VISION  
SYSTEMSUV  
CURING  
SYSTEMSFor Large Scale  
Systems  
For Medium  
Scale Systems**S-LINK**

**ORDER GUIDE**

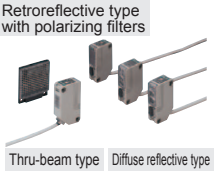
**S-LINK I/O devices**

Designation	Appearance (Note)	Model No.	Description	
Sensor block	Snap-connector	Sensor main block	 <p><b>SL-BMJ</b></p> <p>It allows connection of various kinds of input devices, such as, photoelectric sensors, inductive proximity sensors, limit switches, and push buttons with the snap female connectors. Changes signals from input devices into serial signals and transmits them to the signal transmission line. One <b>SL-BMJ</b> can be extended by one <b>SL-BXJ</b> or two <b>SL-BXs</b>, up to 16 input points. ( It can generate the ORed self-diagnosis output of all the connected devices. ) ( In this case, the first channel gets occupied. )</p>	
		Extension block	 <p><b>SL-BXJ</b></p> <p>It can follow either main block, and allows connection of 8 input devices.</p>	
	For plug-in unit	Sensor main block	 <p><b>SL-BM</b></p> <p>It allows connection of various kinds of plug-in units and changes signals from plug-in units into serial signals and transmits them to the signal transmission line. One <b>SL-BM</b> can be extended by three <b>SL-BXs</b> or one <b>SL-BX</b> plus one <b>SL-BXJ</b>, up to 16 input points. ( It can generate the ORed self-diagnosis output of all connected units. In this ) case, the first channel gets occupied. )</p>	
		Extension block	 <p><b>SL-BX</b></p> <p>It can follow either main block, and allows connection of four plug-in units.</p>	
Plug-in unit	Amplifier-separated photoelectric sensor	 <p><b>SU-7J</b></p> <p>Its thickness is merely 10 mm <b>0.394 in</b>. The sensitivity is automatically set with ease. 12 kinds of sensor heads are suitable with it. (For details, refer to the <b>SU-7/SH</b> series pages.)</p>		
	Input terminal unit	 <p><b>SL-TJ1</b></p> <p>It allows connection of 1 No. of various kinds of input devices, such as, a photoelectric sensor, an inductive proximity sensor or a limit switch.</p>		
S-LINK direct hook-up photoelectric sensor	 <p>Retroreflective type with polarizing filters</p> <p>Thru-beam type    Diffuse reflective type</p>	<b>SL-A11</b>	Thru-beam type 10 m <b>32.808 ft</b>	These can be hooked up to the <b>S-LINK</b> cable, at any place, without any interface.
		<b>SL-A13</b>	Thru-beam type 30 m <b>98.425 ft</b>	
		<b>SL-A19</b>	Retroreflective type with polarizing filters 0.1 to 5 m <b>0.328 to 16.404 ft</b>	
		<b>SL-A12</b>	Diffuse reflective type 700 mm <b>27.559 in</b>	
S-LINK direct hook-up picking sensor	 <p><b>SL-N15</b></p> <p>Sensing range: 0.2 to 3 m <b>0.656 to 9.843 ft</b> ( 0.05 to 1 m <b>0.164 to 3.281 ft</b> ) ( when the switch is set to SHORT )</p> <p>Beam pitch: 25 mm <b>0.984 in</b> Sensing height: 100 mm <b>3.937 in</b> Sensing object: ø35 mm <b>ø1.378 in</b> or more opaque object</p>	<p>It is a parts-taking verification sensor with five sensing beams and can be hooked up to the <b>S-LINK</b> cable without any interface. Both the emitter and the receiver are incorporated with bright orange LED job indicators that are easily visible to the operator.</p>		











Note: Components with "CE" mark conform to the CE marking EMC Directive.

- FIBER SENSORS
- LASER SENSORS
- PHOTO-ELECTRIC SENSORS
- MICRO PHOTO-ELECTRIC SENSORS
- AREA SENSORS
- LIGHT CURTAINS
- PRESSURE / FLOW SENSORS
- INDUCTIVE PROXIMITY SENSORS
- PARTICULAR USE SENSORS
- SENSOR OPTIONS
- SIMPLE WIRE-SAVING UNITS
- WIRE-SAVING SYSTEMS
- MEASURE-MENT SENSORS
- STATIC CONTROL DEVICES
- ENDOSCOPE
- LASER MARKERS
- PLC / TERMINALS
- HUMAN MACHINE INTERFACES
- ENERGY CONSUMPTION VISUALIZATION COMPONENTS
- FA COMPONENTS
- MACHINE VISION SYSTEMS
- UV CURING SYSTEMS
- For Large Scale Systems
- For Medium Scale Systems



## ORDER GUIDE

### Connectors

Designation	Appearance	Model No.	Description	
Hook-up connector	 (Note)	<b>SL-J1A</b> 10 pcs. per set	It creates a "T"-branch connection between two <b>S-LINK</b> exclusive flat cables (4-core). For 0.5 mm <sup>2</sup> flat cable to 0.5 mm <sup>2</sup> flat cable connection (Gray) Applicable hook-up pliers: <b>SL-JPS, SL-JPD</b>	
Cable extension hook-up connector	 (Note)	<b>SL-J3A</b> 10 pcs. per set	It can extend the <b>S-LINK</b> exclusive flat cable (4-core). For 0.5 mm <sup>2</sup> flat cable to 0.5 mm <sup>2</sup> flat cable connection (Black) Applicable hook-up pliers: <b>SL-JPS, SL-JPD</b>	
End hook-up connector	 (Note)	<b>SL-JE</b> 5 pcs. per set	It must be connected at the end of the main cable. For 0.5 mm <sup>2</sup> flat cable (Gray) Applicable hook-up pliers: <b>SL-JPS, SL-JPD</b>	
Cable attached end connector	 (Note)	<b>SL-JE-RC</b> 1 pc.	When cabtyre cable is used as the main cable, it must be connected at the end of the main cable.	
Cable end socket-branch hook-up connector	 (Note)	<b>SL-JK</b> 10 pcs. per set	It enables one I/O device to be connected at the <b>S-LINK</b> exclusive 0.5 mm <sup>2</sup> flat cable (4-core) end with the snap male connector ( <b>SL-CP□</b> ). (Light blue) Applicable hook-up pliers: <b>SL-JPS, SL-JPD</b>	
"T"-branch hook-up connector	 (Note)	<b>SL-JK1</b> 10 pcs. per set	It enables one I/O device to be branched off in the middle of the <b>S-LINK</b> exclusive 0.5 mm <sup>2</sup> flat cable (4-core) with the snap male connector ( <b>SL-CP□</b> ). (Blue) Applicable hook-up pliers: <b>SL-JPS, SL-JPD</b>	
4-pin type snap female connector	 (Note)	<b>SL-CJ1 (White)</b> 10 pcs. per set	For 0.08 to 0.2 mm <sup>2</sup> (Conductor cross-section area) Wire dia.: $\phi 0.7$ to $\phi 1.2$ mm $\phi 0.028$ to $\phi 0.047$ in  This snap female connector is used for plugging into the socket of <b>SL-BMJ</b> or <b>SL-BXJ</b> to connect an input device, or into the snap male connector <b>SL-CP1</b> or <b>SL-CP2</b> . Applicable hook-up pliers: <b>SL-JPC</b>	
	 (Note)	<b>SL-CJ2 (Black)</b> 10 pcs. per set		For 0.3 mm <sup>2</sup> (Conductor cross-section area) Wire dia.: $\phi 1.1$ to $\phi 1.6$ mm $\phi 0.043$ to $\phi 0.063$ in
4-pin type snap male connector	 (Note)	<b>SL-CP1 (White)</b> 10 pcs. per set	For 0.08 to 0.2 mm <sup>2</sup> (Conductor cross-section area) Wire dia.: $\phi 0.7$ to $\phi 1.2$ mm $\phi 0.028$ to $\phi 0.047$ in  This snap male connector is used for connecting <b>S-LINK</b> I/O devices to <b>SL-T8J(-PN)</b> and <b>SL-TP8J(-PN)</b> 8-channel snap-connector I/O units as well as to <b>SL-JK</b> and <b>SL-JK1</b> hook-up connectors. Applicable hook-up pliers: <b>SL-JPC</b> (for the <b>SL-CP1</b> and <b>SL-CP2</b> ) <b>SL-JPE</b> (for the <b>SL-CP3</b> )	
	 (Note)	<b>SL-CP2 (Black)</b> 10 pcs. per set		For 0.3 mm <sup>2</sup> (Conductor cross-section area) Wire dia.: $\phi 1.1$ to $\phi 1.6$ mm $\phi 0.043$ to $\phi 0.063$ in
	 (Note)	<b>SL-CP3 (Greenish blue)</b> 10 pcs. per set		For 0.5 mm <sup>2</sup> (Conductor cross-section area) Wire dia.: $\phi 1.7$ to $\phi 2.5$ mm $\phi 0.067$ to $\phi 0.098$ in

Note: For UL compatibility, please contact our office.

FIBER SENSORS

LASER SENSORS

PHOTO-ELECTRIC SENSORS

MICRO PHOTO-ELECTRIC SENSORS

AREA SENSORS

LIGHT CURTAINS

PRESSURE / FLOW SENSORS

INDUCTIVE PROXIMITY SENSORS

PARTICULAR USE SENSORS

SENSOR OPTIONS

SIMPLE WIRE-SAVING UNITS

WIRE-SAVING SYSTEMS

MEASUREMENT SENSORS

STATIC CONTROL DEVICES

ENDOSCOPE

LASER MARKERS

PLC / TERMINALS

HUMAN MACHINE INTERFACES

ENERGY CONSUMPTION VISUALIZATION COMPONENTS

FA COMPONENTS

MACHINE VISION SYSTEMS

UV CURING SYSTEMS

For Large Scale Systems

For Medium Scale Systems

S-LINK

FIBER SENSORS

LASER SENSORS

PHOTO-ELECTRIC SENSORS

MICRO PHOTO-ELECTRIC SENSORS

AREA SENSORS

LIGHT CURTAINS

PRESSURE / FLOW SENSORS

INDUCTIVE PROXIMITY SENSORS

PARTICULAR USE SENSORS

SENSOR OPTIONS

SIMPLE WIRE-SAVING UNITS

WIRE-SAVING SYSTEMS

MEASUREMENT SENSORS

STATIC CONTROL DEVICES

ENDOSCOPE

LASER MARKERS

PLC / TERMINALS

HUMAN MACHINE INTERFACES

ENERGY CONSUMPTION VISUALIZATION COMPONENTS

FA COMPONENTS

MACHINE VISION SYSTEMS

UV CURING SYSTEMS



For Large Scale Systems

For Medium Scale Systems



**S-LINK**

## ORDER GUIDE

### Basic units





Designation		Appearance	Model No.	Description
I/O module	Vertical type		<b>SL-M8</b>	8 inputs
			<b>SL-M16</b>	16 inputs
			<b>SL-M4P4</b>	4 inputs and 4 outputs
			<b>SL-MP8</b>	8 outputs
	Horizontal type		<b>SL-M8F</b>	8 inputs
			<b>SL-M16F</b>	16 inputs
			<b>SL-M4P4F</b>	4 inputs and 4 outputs
			<b>SL-MP8F</b>	8 outputs
			<b>SL-MP16F</b>	16 outputs
These are IC type modules which enable external connection of address setting switches and operation indicators. They increase the design flexibility.				

### Optional units

Designation	Appearance	Model No.	Description
Booster		<b>SL-BS1A</b>	It can extend the signal transmission distance by 200 m <b>656.168 ft.</b> A maximum of seven boosters can be connected for one <b>S-LINK</b> control unit. However, one booster can never be followed by another booster in series.
Handy monitor		<b>SL-HM1</b>	It can be connected at any place on the signal transmission line and the I/O states can be checked in batches of 16. The handy monitor is also incorporated with the <b>S-LINK</b> control functions, so that, for example, it can perform an I/O check on conveyor system segments, still under assembly, even without the <b>S-LINK</b> controller.

Note: Components with "CE" mark conform to the CE marking EMC Directive.

**ORDER GUIDE****Others**

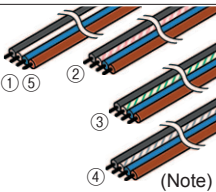
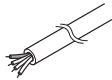
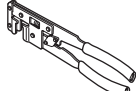
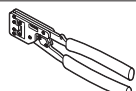
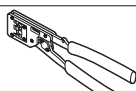
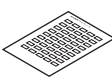
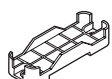
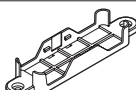
Designation	Appearance	Model No.	Description		
8-branch connector tap		<b>SL-T8PW</b>	Connects easily to up to 8 thru-beam type photoelectric sensor emitters or <b>S-LINK</b> I/O devices with snap male connectors.		
2-pin type snap female connector	 (Note)	<b>SL-CJ12</b> (White) 10 pcs. per set	For 0.08 to 0.2 mm <sup>2</sup> (Conductor cross-section area) Wire dia.: $\varnothing 0.7$ to $\varnothing 1.2$ mm $\varnothing 0.028$ to $\varnothing 0.047$ in	It can be used for cable extension of 2-wire I/O devices by combining with a 2-pin type snap male connector <b>SL-CP<math>\square</math>2</b> . Applicable hook-up pliers: <b>SL-JPC</b>	
	 (Note)	<b>SL-CJ22</b> (Black) 10 pcs. per set	For 0.3 mm <sup>2</sup> (Conductor cross-section area) Wire dia.: $\varnothing 1.1$ to $\varnothing 1.6$ mm $\varnothing 0.043$ to $\varnothing 0.063$ in		
2-pin type snap male connector	 (Note)	<b>SL-CP12</b> (White) 10 pcs. per set	For 0.08 to 0.2 mm <sup>2</sup> (Conductor cross-section area) Wire dia.: $\varnothing 0.7$ to $\varnothing 1.2$ mm $\varnothing 0.028$ to $\varnothing 0.047$ in	It can be used for cable extension of 2-wire I/O devices by combining with a 2-pin type snap female connector <b>SL-CJ<math>\square</math>2</b> . Applicable hook-up pliers: <b>SL-JPC</b>	
	 (Note)	<b>SL-CP22</b> (Black) 10 pcs. per set	For 0.3 mm <sup>2</sup> (Conductor cross-section area) Wire dia.: $\varnothing 1.1$ to $\varnothing 1.6$ mm $\varnothing 0.043$ to $\varnothing 0.063$ in		
Exclusive flat cable (4-core)	 (Note)	<b>SL-RCM100</b>	Length: 100 m <b>328.084 ft</b>	<b>S-LINK / S-LINK V</b> exclusive flat cable (4-core) Conductor cross-section area: 0.5 mm <sup>2</sup> Outer diameter: $\varnothing 2.5$ mm $\varnothing 0.098$ in $\times 4$	
		<b>SL-RCM100-PK</b>			D line: White with pink stripe ②
		<b>SL-RCM100-GN</b>			D line: White with green stripe ③
		<b>SL-RCM100-GY</b>			D line: White with gray stripe ④
		<b>SL-RCM200</b>			Length: 200 m <b>656.168 ft</b> , D line: White ⑤
Exclusive cabtyre cable (4-core)		<b>SL-CBM100</b>	Length: 100 m <b>328.084 ft</b>	<b>S-LINK / S-LINK V</b> exclusive cabtyre cable (4-core) Conductor cross-section area: 0.5 mm <sup>2</sup> Outer diameter: $\varnothing 7.4$ mm $\varnothing 0.291$ in (Hook-up connector cannot be used)	
		<b>SL-CBM200</b>	Length: 200 m <b>656.168 ft</b>		
Exclusive pliers		<b>SL-JPS</b>	Hook-up connector ( <b>SL-J<math>\square</math></b> ) can be connected in one grip.		
<b>SL-CP3</b> exclusive pliers		<b>SL-JPE</b>	4-pin type snap male connector ( <b>SL-CP3</b> ) can be connected in one grip.		
Male / female connector exclusive pliers		<b>SL-JPC</b>	Snap female connector ( <b>SL-CJ1/CJ2</b> , <b>SL-CJ11/CJ12</b> ) and snap male connector ( <b>SL-CP1/CP2</b> , <b>SL-CP11/CP12</b> ) can be connected in one grip.		
Address label		<b>SL-MA1-SET</b> 4 sheets. per set	By sticking the labels on the respective <b>S-LINK</b> devices, the set addresses can be confirmed at one glance. <b>SL-MA1-SET</b> is available in white, pink, green and gray colors, as a 4-sheet set, and is convenient when used by matching the color with that of the <b>S-LINK</b> exclusive flat cable (100 m <b>328.084 ft</b> type).		
DIN rail mounting bracket for <b>SL-CH<math>\square</math></b>		<b>MS-CH<math>\times 10</math></b> 10 pcs. per set	Mounting bracket enabling the <b>SL-CH<math>\square</math>(-PN)</b> I/O units to be mounted onto a 35 mm <b>1.378 in</b> width DIN rail. They can also be affixed with screws. (When affixing with screws, arrange two M4 pan-head screws separately.)		
I/O unit holder for <b>SL-CH<math>\square</math></b>		<b>MS-SLH</b> 5 pcs. per set	It is used to mount the <b>SL-CH<math>\square</math>(-PN)</b> unit. (Please arrange two M4 pan-head screws separately.)		

Note: For UL compatibility, please contact our office.

FIBER  
SENSORSLASER  
SENSORSPHOTO-  
ELECTRIC  
SENSORSMICRO  
PHOTO-  
ELECTRIC  
SENSORSAREA  
SENSORSLIGHT  
CURTAINSPRESSURE /  
FLOW  
SENSORSINDUCTIVE  
PROXIMITY  
SENSORSPARTICULAR  
USE  
SENSORSSENSOR  
OPTIONSSIMPLE  
WIRE-SAVING  
UNITSWIRE-SAVING  
SYSTEMSMEASURE-  
MENT  
SENSORSSTATIC  
CONTROL  
DEVICES

ENDOSCOPE

LASER  
MARKERSPLC /  
TERMINALSHUMAN  
MACHINE  
INTERFACESENERGY  
CONSUMPTION  
VISUALIZATION  
COMPONENTSFA  
COMPONENTSMACHINE  
VISION  
SYSTEMSUV  
CURING  
SYSTEMSFor Large Scale  
SystemsFor Medium  
Scale Systems**S-LINK**

FIBER SENSORS

LASER SENSORS

PHOTO-ELECTRIC SENSORS  
MICRO PHOTO-ELECTRIC SENSORS

AREA SENSORS

LIGHT CURTAINS

PRESSURE / FLOW SENSORS

INDUCTIVE PROXIMITY SENSORS

PARTICULAR USE SENSORS

SENSOR OPTIONS

SIMPLE WIRE-SAVING UNITS

WIRE-SAVING SYSTEMS

MEASUREMENT SENSORS

STATIC CONTROL DEVICES

ENDOSCOPE

LASER MARKERS

PLC / TERMINALS

HUMAN MACHINE INTERFACES

ENERGY CONSUMPTION VISUALIZATION COMPONENTS

FA COMPONENTS

MACHINE VISION SYSTEMS

UV CURING SYSTEMS

For Large Scale Systems

For Medium Scale Systems

**S-LINK**

## ORDER GUIDE

### Accessories

• **NPS-CV**

(Protective cover for the **SL-CU1A**, **SL-BS1A** or **SL-CU1-485**)

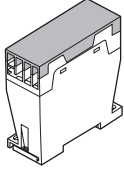

• **RF-230**

(Reflector for the **SL-A19**)



• **MS-SL-2**

(Mounting base for connector I/O units)

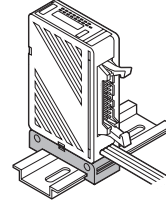

## OPTIONS

Designation	Model No.	Description
Sensor mounting bracket for <b>SL-A</b> □	<b>MS-NX5-1</b>	Foot angled mounting bracket (The thru-beam type sensor needs two brackets.)
	<b>MS-NX5-2</b>	Foot biangled mounting bracket (sensor protection bracket) (The thru-beam type sensor needs two brackets.)
	<b>MS-NX5-3</b>	Back angled mounting bracket (The thru-beam type sensor needs two brackets.)
Sensor mounting bracket for <b>SL-N15</b>	<b>MS-NA1-1</b>	Four bracket set Four M4 (length 15 mm 0.591 in) screws with washers, eight nuts, four hooks, four spacers and eight M4 (length 18 mm 0.709 in) screws with washers are attached. (Spacers are not attached with <b>MS-NA1-1</b> .)
	<b>MS-NA2-1</b>	
Sensor protection bracket for <b>SL-N15</b>	<b>MS-NA3</b>	It protects the sensor body. Two bracket set (Silver) Four M4 (length 15 mm 0.591 in) screws with washers, and four nuts are attached.
	<b>MS-NA3-BK</b>	It protects the sensor body. Two bracket set (Black) Four M4 (length 15 mm 0.591 in) screws with washers, and four nuts are attached.
Reflector mounting bracket	<b>MS-RF23</b>	Reflector mounting bracket for <b>RF-230</b>
Slit mask for <b>SL-N15</b>	<b>OS-NA1-5</b> 10 sheets. per set	The seal type slit mask restrains the amount of beam emitted or received. (Take care that the sensing range will be reduced when the slit mask is used.)
Connector I/O unit mounting bracket, 8-branch connector tap mounting bracket	<b>MS-DIN-3</b>	It is a DIN rail mounting bracket which can be fitted on the mounting base of <b>SL-T8J</b> , <b>SL-TP8J</b> , <b>SL-T16C1</b> , <b>SL-TP16C1</b> and <b>SL-T8PW</b> .
DIN rail adapter	<b>MS-DIN-IDC</b>	This adapter is used when mounting the <b>SL-GU1</b> □ to the 35 mm 1.378 in width DIN rail.

### Sensor mounting bracket for **SL-A**□

• **MS-NX5-1**

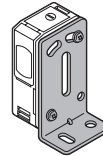

Two M4 (length 25 mm 0.984 in) screws with washers and two M4 nuts are attached.

• **MS-NX5-2**

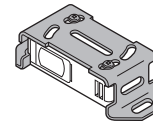

Two M4 (length 25 mm 0.984 in) screws with washers and two M4 nuts are attached.

• **MS-NX5-3**

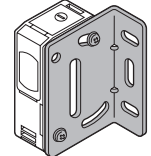

Two M4 (length 25 mm 0.984 in) screws with washers and two M4 nuts are attached.

### Sensor mounting bracket for **SL-N15**

• **MS-NA1-1**

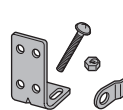

M4 screws with washers, nuts and hooks are attached.

• **MS-NA2-1**

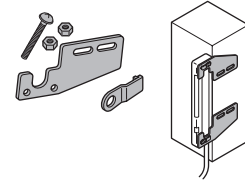

M4 screws with washers, nuts, hooks and spacers are attached.

### Sensor protection bracket for **SL-N15**

• **MS-NA3**

• **MS-NA3-BK**

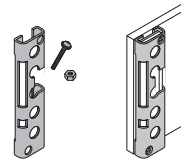

M4 screws with washers and nuts are attached.

### Reflector mounting bracket

• **MS-RF23**



Two M4 (length 10 mm 0.394 in) screws with washers are attached.

### DIN rail adapter

• **MS-DIN-IDC**

Two M4 (length 12 mm 0.472 in) screws with washers  
(Two pcs. are attached with the DIN rail adapter)

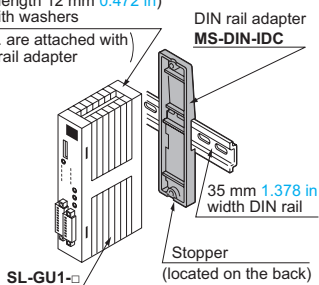

### Slit mask for **SL-N15**

• **OS-NA1-5**

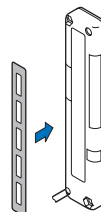

### Connector I/O unit mounting bracket, 8-branch connector tap mounting bracket

• **MS-DIN-3**

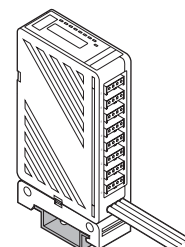

**PRECAUTIONS FOR PROPER USE**



- Never use this product in a device for personal protection.
- In case of using sensing devices for personnel protection, use products which meet laws and standards, such as OSHA, ANSI or IEC etc., for personnel protection applicable in each region or country.
- Handle safety related or emergency stop signals without passing them through the **S-LINK** system due to fail-safe considerations.
- Before touching this product, remove any electrostatic charge that may be present on your body. There is a danger of this product getting damaged due to the electrostatic charge.

The sensor & wire-saving link system **S-LINK** are not mutually interchangeable with the flexible wire-saving system **S-LINK V** and cannot be mixed or matched. Please exercise caution.

Nevertheless, any of the exclusive 4-core flat cable, connectors, hook-up pliers, or **SL-T8PW** 8-branch connector taps can be used.

**Information about S-LINK partner makers**

Refer directly to our partner makers for more details pertaining to the S-LINK compatible devices introduced here.

**[Controllers suitable for S-LINK]**

JTEKT Corp.



**[S-LINK direct hook-up I/O devices]**

**Component indicator lamp**

Yazaki Industrial Chemical Co., Ltd.



**Manifold electromagnetic valves**

Koganei Corp.



**Manifold electromagnetic valves**

SMC Pneumatics

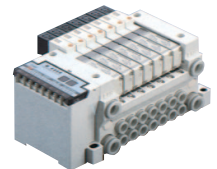

**Manifold electromagnetic valves**

CKD Corp.

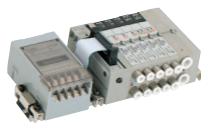

**Information about the “Design Manual” and “Construction Manual” for the S-LINK sensor & wire-saving link system**

We have two manuals available with more detailed information pertaining to the S-LINK sensor & wire-saving link system. Please contact our office for details.



**S-LINK Design Manual**

Holds information necessary when designing the layout for the **S-LINK** system. Refer to it for specifications and for illustration showing exterior dimensions.



**S-LINK Construction Manual**

Holds information necessary when introducing, constructing, and activating the **S-LINK** system. Refer to it for construction or startup cautionary items.

FIBER SENSORS

LASER SENSORS

PHOTO-ELECTRIC SENSORS

MICRO PHOTO-ELECTRIC SENSORS

AREA SENSORS

LIGHT CURTAINS

PRESSURE / FLOW SENSORS

INDUCTIVE PROXIMITY SENSORS

PARTICULAR USE SENSORS

SENSOR OPTIONS

SIMPLE WIRE-SAVING UNITS

WIRE-SAVING SYSTEMS

MEASURE-MENT SENSORS

STATIC CONTROL DEVICES

ENDOSCOPE

LASER MARKERS

PLC / TERMINALS

HUMAN MACHINE INTERFACES

ENERGY CONSUMPTION VISUALIZATION COMPONENTS

FA COMPONENTS

MACHINE VISION SYSTEMS

UV CURING SYSTEMS

For Large Scale Systems

For Medium Scale Systems

**S-LINK**