



Chipsmall Limited consists of a professional team with an average of over 10 year of expertise in the distribution of electronic components. Based in Hongkong, we have already established firm and mutual-benefit business relationships with customers from,Europe,America and south Asia,supplying obsolete and hard-to-find components to meet their specific needs.

With the principle of “Quality Parts,Customers Priority,Honest Operation,and Considerate Service”,our business mainly focus on the distribution of electronic components. Line cards we deal with include Microchip,ALPS,ROHM,Xilinx,Pulse,ON,Everlight and Freescale. Main products comprise IC,Modules,Potentiometer,IC Socket,Relay,Connector.Our parts cover such applications as commercial,industrial, and automotives areas.

We are looking forward to setting up business relationship with you and hope to provide you with the best service and solution. Let us make a better world for our industry!



Contact us

Tel: +86-755-8981 8866 Fax: +86-755-8427 6832

Email & Skype: info@chipsmall.com Web: www.chipsmall.com

Address: A1208, Overseas Decoration Building, #122 Zhenhua RD., Futian, Shenzhen, China



NPN Darlington Transistor Array with Freewheeling Diode

SLA4051

Features

- Built-in 9-elements NPN Darlington transistor
- Built-in freewheeling diode
- High DC current gain

- V_{CE} ----- 120 V
- $I_{C(DC)}$ ----- 2 A
- $V_{CE(sat)}$ -----1.1 V typ.
- h_{FE} ----- 5000 typ.

Package

SIP 21 with Fin (SLA-21pin)

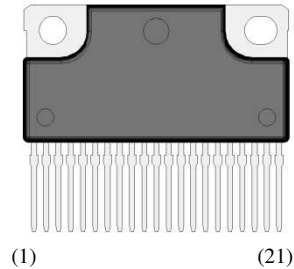

Not to scale

Applications

- Relay driver
- Solenoid driver
- Lamp driver
- LED drive

Equivalent circuit

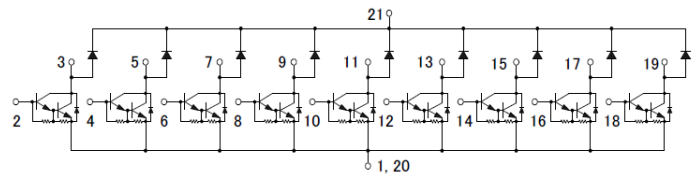

Absolute Maximum Ratings

● Unless otherwise specified, $T_A = 25\text{ }^\circ\text{C}$

Parameter	Symbol	Test conditions	Rating	Unit
Collector-Base Voltage	V_{CBO}		120	V
Collector-Emitter Voltage	V_{CEO}		120	V
Emitter-Base Voltage	V_{EBO}		6	V
Collector Current	$I_{C(DC)}$		2	A
Collector Current (pulse)	$I_{C(PULSE)}$	PW \leq 1ms Duty cycle \leq 50 %	4	A
Base Current	I_B		0.2	A
Diode Forward Current	I_F	PW \leq 0.5ms Duty cycle \leq 25%	2	A
Diode Forward Current (pulse)	I_{FSM}	PW \leq 10ms, Single Pulse	4	A
Diode Reverse Voltage	V_R		120	V
Maximum Allowable Power Dissipation	P_T	No. Fin. $T_A=25^\circ\text{C}$ All Element Operation	5	W
		$T_C=25^\circ\text{C}$ All Element Operation	25	W
Junction Temperature	T_J		150	$^\circ\text{C}$
Storage Temperature	T_{stg}		- 40 to 150	$^\circ\text{C}$

Electrical Characteristics

• $T_A = 25\text{ }^\circ\text{C}$

○ Transistor

Parameter	Symbol	Test Conditions	Min.	Typ.	Max.	Unit
Collector Cut-off Current	I_{CBO}	$V_{CB} = 120\text{ V}$	–	–	10	μA
Emitter Cut-off Current	I_{EBO}	$V_{EB} = 6\text{ V}$	–	–	10	mA
Collector-Emitter Voltage	V_{CEO}	$I_C = 10\text{ mA}$	120	–	–	V
Collector-Emitter Voltage	$V_{CEO(SUS)}$	$I_C = 1\text{ A}$	120	–	–	V
DC Current Transfer Ratio	h_{FE}	$V_{CE} = 4\text{ V}, I_C = 1\text{ A}$	2000	5000	12000	
Collector-Emitter Saturation Voltage	$V_{CE(sat)}$	$I_C = 1\text{ A}, I_B = 2\text{ mA}$	–	1.1	1.5	V
Base-Emitter Saturation Voltage	$V_{BE(sat)}$	$I_C = 1\text{ A}, I_B = 2\text{ mA}$	–	1.8	2.2	V
Emitter-Collector Diode Forward Voltage	V_{FEC}	$I_{FEC} = 0.5\text{ A}$	–	1.3	1.8	V
Turn-On Time	t_{on}	$V_{CC} \doteq 30\text{ V}$ $I_C = 1.5\text{ A}$ $I_B = \pm 3\text{ mA}$	–	0.5	–	μs
Storage Time	t_{stg}		–	4.5	–	
Fall Time	t_f		–	1.2	–	
Cut-off Frequency	f_T	$V_{CE} = 12\text{ V}, I_E = -0.1\text{ A}$	–	50	–	MHz
Output Capacitance	C_{ob}	$V_{CB} = 10\text{ V}, f = 1\text{ MHz}$	–	20	–	pF

○ Flyback Diode

Parameter	Symbol	Test Conditions	Min.	Typ.	Max.	Unit
Reverse Voltage	V_R	$I_R = 10\text{ }\mu\text{A}$	120	–	–	V
Forward Voltage	V_F	$I_F = 1\text{ A}$	–	–	1.8	V
Reverse Current	I_R	$V_R = 120\text{ V}$	–	–	10	μA
Reverse Recovery Time	t_{rr}	$I_F = \pm 100\text{ mA}$	–	100	–	ns

Performance Curves

Ic-VCE Characteristics (Typical)

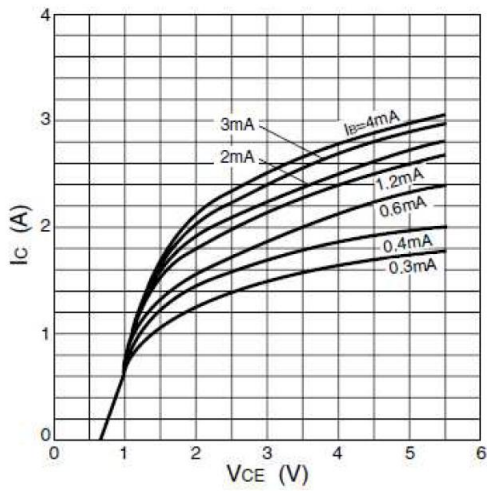

hFE-Ic Characteristics (Typical)

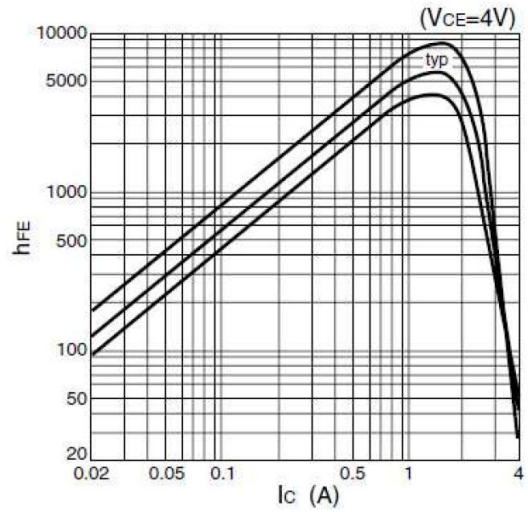

hFE-Ic Temperature Characteristics (Typical)

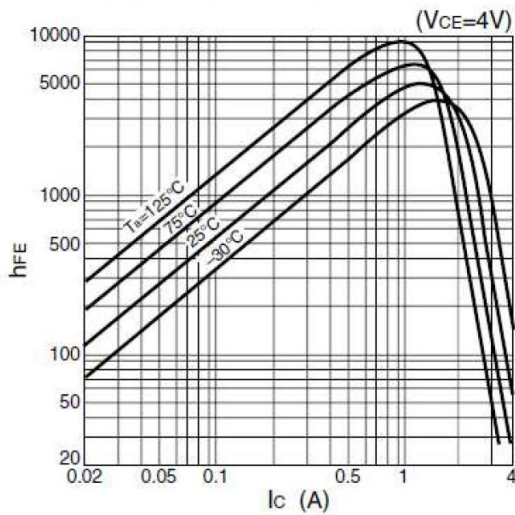

VCE(sat)-Ib Characteristics (Typical)

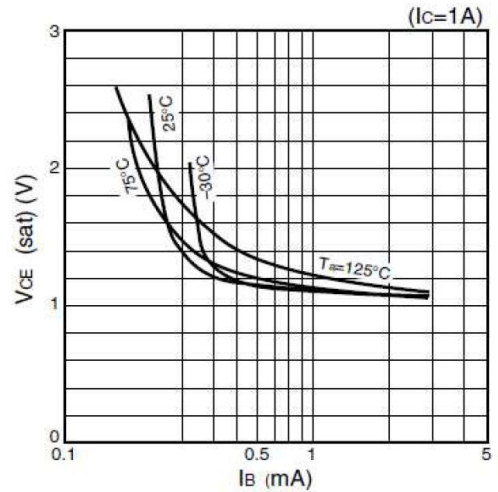

Ic-VBE Temperature Characteristics (Typical)

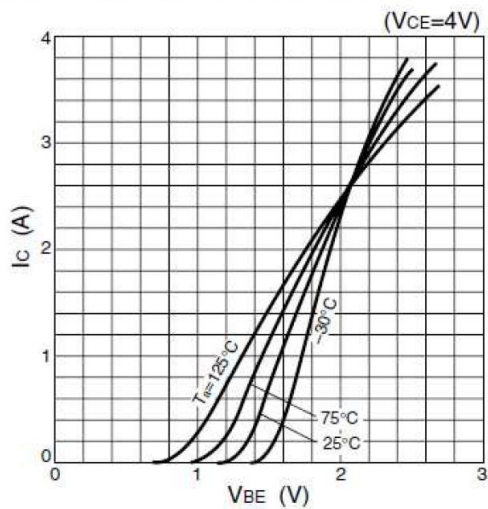

θ_{j-a} -PW Characteristics

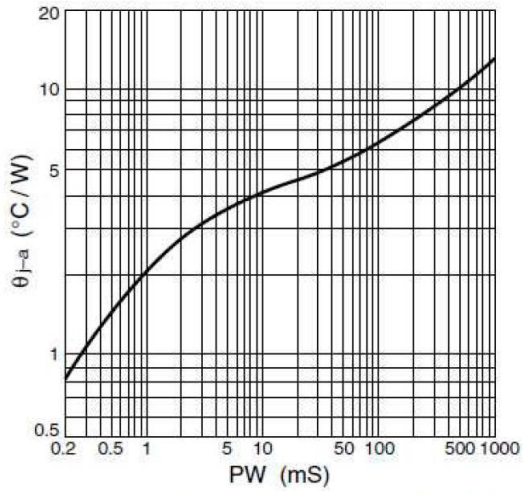

P_T-T_a Characteristics

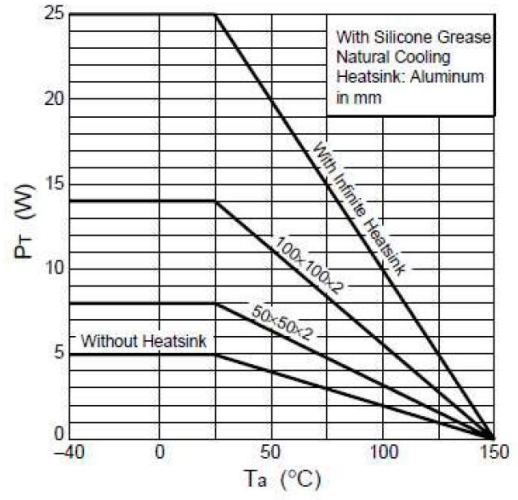

Safe Operating Area (SOA)

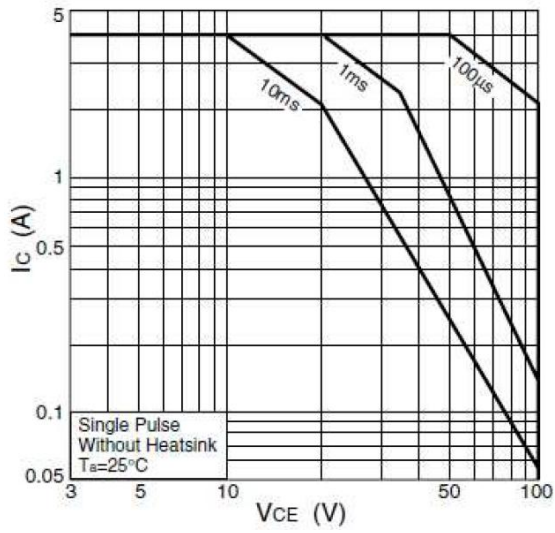

SLA4051

Package Outline

SIP21 (LF No. 2108)

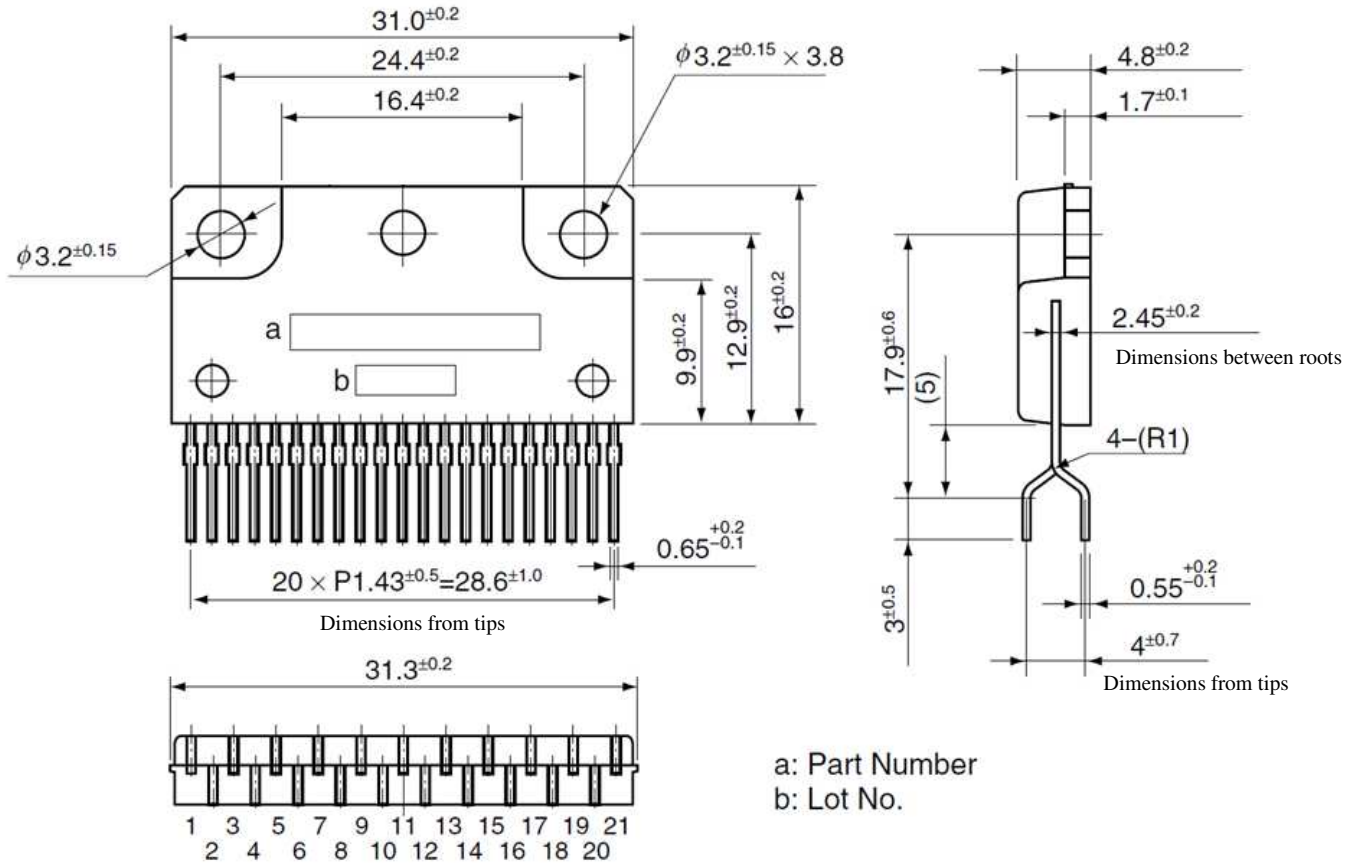

Marking Diagram

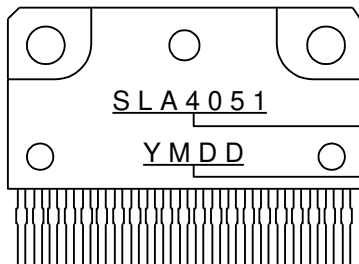

Part Number

Lot Number

Y is the Last digit of the year (0 to 9)

M is the Month (1 to 9, O, N or D)

DD is the Date (two digit of 01 to 31)

OPERATING PRECAUTIONS

In the case that you use Sanken products or design your products by using Sanken products, the reliability largely depends on the degree of derating to be made to the rated values. Derating may be interpreted as a case that an operation range is set by derating the load from each rated value or surge voltage or noise is considered for derating in order to assure or improve the reliability. In general, derating factors include electric stresses such as electric voltage, electric current, electric power etc., environmental stresses such as ambient temperature, humidity etc. and thermal stress caused due to self-heating of semiconductor products. For these stresses, instantaneous values, maximum values and minimum values must be taken into consideration. In addition, it should be noted that since power devices or IC's including power devices have large self-heating value, the degree of derating of junction temperature affects the reliability significantly.

Because reliability can be affected adversely by improper storage environments and handling methods, please observe the following cautions.

Cautions for Storage

- Ensure that storage conditions comply with the standard temperature (5 to 35°C) and the standard relative humidity (around 40 to 75%); avoid storage locations that experience extreme changes in temperature or humidity.
- Avoid locations where dust or harmful gases are present and avoid direct sunlight.
- Reinspect for rust on leads and solderability of the products that have been stored for a long time.

Cautions for Testing and Handling

When tests are carried out during inspection testing and other standard test periods, protect the products from power surges from the testing device, shorts between the product pins, and wrong connections. Ensure all test parameters are within the ratings specified by Sanken for the products.

Remarks About Using Thermal Silicone Grease

- When thermal silicone grease is used, it shall be applied evenly and thinly. If more silicone grease than required is applied, it may produce excess stress.
- The thermal silicone grease that has been stored for a long period of time may cause cracks of the greases, and it cause low radiation performance. In addition, the old grease may cause cracks in the resin mold when screwing the products to a heatsink.
- Fully consider preventing foreign materials from entering into the thermal silicone grease. When foreign material is immixed, radiation performance may be degraded or an insulation failure may occur due to a damaged insulating plate.
- The thermal silicone greases that are recommended for the resin molded semiconductor should be used. Our recommended thermal silicone grease is the following, and equivalent of these.

Type	Suppliers
G746	Shin-Etsu Chemical Co., Ltd.
YG6260	Momentive Performance Materials Japan LLC
SC102	Dow Corning Toray Co., Ltd.

Cautions for Mounting to a Heatsink

- When the flatness around the screw hole is insufficient, such as when mounting the products to a heatsink that has an extruded (burred) screw hole, the products can be damaged, even with a lower than recommended screw torque. For mounting the products, the mounting surface flatness should be 0.05mm or less.
- Please select suitable screws for the product shape. Do not use a flat-head machine screw because of the stress to the products. Self-tapping screws are not recommended. When using self-tapping screws, the screw may enter the hole diagonally, not vertically, depending on the conditions of hole before threading or the work situation. That may stress the products and may cause failures.
- Recommended screw torque:

Package	Recommended Screw Torque
TO-220, TO-220F	0.490 to 0.686 N·m (5 to 7 kgf·cm)
TO-3P, TO-3PF, TO-247	0.686 to 0.882 N·m (7 to 9 kgf·cm)
SLA	0.588 to 0.784 N·m (6 to 8 kgf·cm)

- For tightening screws, if a tightening tool (such as a driver) hits the products, the package may crack, and internal stress fractures may occur, which shorten the lifetime of the electrical elements and can cause catastrophic failure. Tightening with an air driver makes a substantial impact. In addition, a screw torque higher than the set torque can be applied and the package may be damaged. Therefore, an electric driver is recommended.
When the package is tightened at two or more places, first pre-tighten with a lower torque at all places, then tighten with the specified torque. When using a power driver, torque control is mandatory.
- Please pay special attention about the slack of the press mold. In case that the hole diameter of the heatsink is less than 4 mm, it may cause the resin crack at tightening.

Soldering

- When soldering the products, please be sure to minimize the working time, within the following limits:
 - $260 \pm 5 \text{ }^{\circ}\text{C}$ $10 \pm 1 \text{ s}$ (Flow, 2 times)
 - $380 \pm 10 \text{ }^{\circ}\text{C}$ $3.5 \pm 0.5 \text{ s}$ (Soldering iron, 1 time)
- Soldering should be at a distance of at least 1.5 mm from the body of the products.

Electrostatic Discharge

- When handling the products, the operator must be grounded. Grounded wrist straps worn should have at least $1\text{M}\Omega$ of resistance from the operator to ground to prevent shock hazard, and it should be placed near the operator.
- Workbenches where the products are handled should be grounded and be provided with conductive table and floor mats.
- When using measuring equipment such as a curve tracer, the equipment should be grounded.
- When soldering the products, the head of soldering irons or the solder bath must be grounded in order to prevent leak voltages generated by them from being applied to the products.
- The products should always be stored and transported in Sanken shipping containers or conductive containers, or be wrapped in aluminum foil.

IMPORTANT NOTES

- The contents in this document are subject to changes, for improvement and other purposes, without notice. Make sure that this is the latest revision of the document before use.
- Application examples, operation examples and recommended examples described in this document are quoted for the sole purpose of reference for the use of the products herein and Sanken can assume no responsibility for any infringement of industrial property rights, intellectual property rights, life, body, property or any other rights of Sanken or any third party which may result from its use.
- Unless otherwise agreed in writing by Sanken, Sanken makes no warranties of any kind, whether express or implied, as to the products, including product merchantability, and fitness for a particular purpose and special environment, and the information, including its accuracy, usefulness, and reliability, included in this document.
- Although Sanken undertakes to enhance the quality and reliability of its products, the occurrence of failure and defect of semiconductor products at a certain rate is inevitable. Users of Sanken products are requested to take, at their own risk, preventative measures including safety design of the equipment or systems against any possible injury, death, fires or damages to the society due to device failure or malfunction.
- Sanken products listed in this document are designed and intended for the use as components in general purpose electronic equipment or apparatus (home appliances, office equipment, telecommunication equipment, measuring equipment, etc.).
When considering the use of Sanken products in the applications where higher reliability is required (transportation equipment and its control systems, traffic signal control systems or equipment, fire/crime alarm systems, various safety devices, etc.), and whenever long life expectancy is required even in general purpose electronic equipment or apparatus, please contact your nearest Sanken sales representative to discuss, prior to the use of the products herein.
The use of Sanken products without the written consent of Sanken in the applications where extremely high reliability is required (aerospace equipment, nuclear power control systems, life support systems, etc.) is strictly prohibited.
- When using the products specified herein by either (i) combining other products or materials therewith or (ii) physically, chemically or otherwise processing or treating the products, please duly consider all possible risks that may result from all such uses in advance and proceed therewith at your own responsibility.
- Anti radioactive ray design is not considered for the products listed herein.
- Sanken assumes no responsibility for any troubles, such as dropping products caused during transportation out of Sanken's distribution network.
- The contents in this document must not be transcribed or copied without Sanken's written consent.