



Chipsmall Limited consists of a professional team with an average of over 10 year of expertise in the distribution of electronic components. Based in Hongkong, we have already established firm and mutual-benefit business relationships with customers from,Europe,America and south Asia,supplying obsolete and hard-to-find components to meet their specific needs.

With the principle of "Quality Parts,Customers Priority,Honest Operation,and Considerate Service",our business mainly focus on the distribution of electronic components. Line cards we deal with include Microchip,ALPS,ROHM,Xilinx,Pulse,ON,Everlight and Freescale. Main products comprise IC,Modules,Potentiometer,IC Socket,Relay,Connector.Our parts cover such applications as commercial,industrial, and automotives areas.

We are looking forward to setting up business relationship with you and hope to provide you with the best service and solution. Let us make a better world for our industry!



Contact us

Tel: +86-755-8981 8866 Fax: +86-755-8427 6832

Email & Skype: info@chipsmall.com Web: www.chipsmall.com

Address: A1208, Overseas Decoration Building, #122 Zhenhua RD., Futian, Shenzhen, China



For partial switching PFC Integrated IGBT and Diode Bridge Rectifier SLA5222

Features

- SLA5222 incorporates IGBT and diodes for bridge rectifier of partial switching PFC, and achieves board space reduction.
- Low Saturation Voltage IGBT
- Low V_F Diode Bridge Rectifier
- Clip Lead is adopted for inner lead
 - Low Inductance
 - Low Resistance
 - High Power Dissipation
 - Smoke generation and explosion are less likely to occur in case of destruction

- V_{CE} ----- 600 V
- I_C ----- 30 A ($T_C = 100\text{ }^\circ\text{C}$)
- $V_{CE(sat)}$ ----- 1.3 V typ.
- t_f ----- 170 ns typ.

Package

SLA

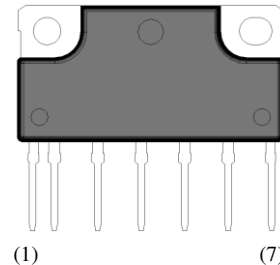

Not to scale

Applications

For partial switching PFC

- Air conditioner
- Other SMPS

Equivalent circuit

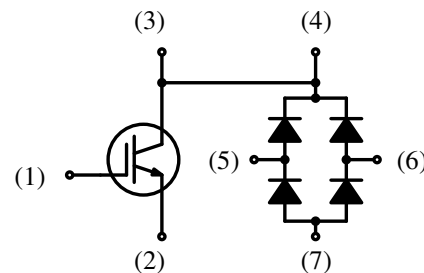

Absolute Maximum Ratings

- Unless otherwise specified, $T_A = 25\text{ }^\circ\text{C}$

Parameter	Symbol	Test conditions	Rating	Unit
Collector to Emitter Voltage	V_{CES}		600	V
Gate to Emitter Voltage	V_{GE}		± 30	V
Continuous Collector Current	$I_{C(DC)}$	$T_C = 25\text{ }^\circ\text{C}$	30	A
Pulsed Collector Current	$I_{C(PULSE)}^{*1}$	$PW \leq 1ms$ Duty cycle $\leq 1\%$	100	A
Maximum Collector to Emitter dv/dt	dv/dt^{*2}	$T_C \leq 125\text{ }^\circ\text{C}$ Refer to Figure 1	5	V/ns
Diode Peak Reverse Voltage	V_{RM}		600	V
Diode Forward Current	I_F		25	A
Diode Peak Surge Forward Current	I_{FSM}^{*3}	$PW \leq 10ms$, Half sinewave, 1 shot	200	A
Diode I^2t Limiting Value	I^2t^{*4}	$1\text{ ms} \leq PW \leq 10\text{ ms}$	200	A^2s
Maximum Allowable Power Dissipation	P_T^{*5}	No. Fin. All Element Operation	5	W
		All Element Operation	92	W
Isolation Voltage	V_{ISO}	Between fin and all pins	1500	Vrms
Operating Junction Temperature	T_J		150	$^\circ\text{C}$
Storage Temperature Range	T_{stg}		- 40 to 150	$^\circ\text{C}$

Thermal Characteristics

• Unless otherwise specified, $T_A = 25\text{ }^\circ\text{C}$

Parameter	Symbol	Conditions	Min.	Typ.	Max.	Unit
Thermal Resistance (Junction to Ambient)	θ_{j-A}	All Element Operation	–	–	25	$^\circ\text{C}/\text{W}$
Thermal Resistance (Junction to Case)	θ_{j-C}	All Element Operation	–	–	1.36	$^\circ\text{C}/\text{W}$
Thermal Resistance (Junction to Case)	θ_{j-C} IGBT	IGBT 1 Element Operation	–	–	3.91	$^\circ\text{C}/\text{W}$
Thermal Resistance (Junction to Case)	θ_{j-C} Di	Diode 1 Element Operation	–	–	8.33	$^\circ\text{C}/\text{W}$

Electrical Characteristics

• Unless otherwise specified, $T_A = 25\text{ }^\circ\text{C}$

Parameter	Symbol	Test Conditions	Min.	Typ.	Max.	Unit
IGBT						
Collector to Emitter Breakdown Voltage	$V_{(BR)CES}$	$I_C = 100\text{ }\mu\text{A}$, $V_{GE} = 0\text{ V}$	600	–	–	V
Collector to Emitter Leakage Current	I_{CES}	$V_{CE} = 600\text{ V}$, $V_{GE} = 0\text{ V}$	–	–	100	μA
Gate to Emitter Leakage Current	I_{GES}	$V_{GE} = \pm 30\text{ V}$	–	–	± 500	nA
Gate Threshold Voltage	$V_{GE(TH)}$	$V_{CE} = 10\text{ V}$, $I_C = 1\text{ mA}$	3	–	6	V
Gate Threshold Voltage Temperature Coefficient	$\Delta V_{GE(TH)}$	$V_{CE} = 10\text{ V}$, $I_D = 1\text{ mA}$	–	8.5	–	$\text{mV}/^\circ\text{C}$
Collector to Emitter Saturation Voltage	$V_{CE(sat)}$	$V_{GE} = 15\text{ V}$, $I_C = 30\text{ A}$	–	1.3	1.7	V
		$V_{GE} = 15\text{ V}$, $I_C = 50\text{ A}$	–	1.6	–	V
Input Capacitance	C_{ies}	$V_{CE} = 20\text{ V}$ $V_{GE} = 0\text{ V}$ $f = 1.0\text{ MHz}$	–	2500	–	pF
Output Capacitance	C_{oes}		–	150	–	
Reverse Transfer Capacitance	C_{res}		–	80	–	
Total Gate Charge	Q_g	$V_{CE} = 300\text{ V}$ $I_C = 30\text{ A}$ $V_{GE} = 15\text{ V}$	–	65	–	nC
Gate to Emitter Charge	Q_{ge}		–	20	–	
Gate to Collector Charge	Q_{gc}		–	20	–	
Turn-On Delay Time	$t_{d(on)}$	$T_C = 25\text{ }^\circ\text{C}$ Refer to Figure 1	–	70	–	ns
Rise Time	t_r		–	70	–	
Turn-Off Delay Time	$t_{d(off)}$		–	280	–	
Fall Time	t_f		–	170	–	
Turn-On Delay Time	$t_{d(on)}$	$T_C = 125\text{ }^\circ\text{C}$ Refer to Figure 1	–	70	–	ns
Rise Time	t_r		–	75	–	
Turn-Off Delay Time	$t_{d(off)}$		–	320	–	
Fall Time	t_f		–	300	–	
Diode						
Forward Voltage Drop	V_F	$I_F = 12.5\text{ A}$	–	–	1.1	V
Reverse Leakage Current	I_R	$V_R = 600\text{ V}$	–	–	50	μA

Test Circuits and Waveforms

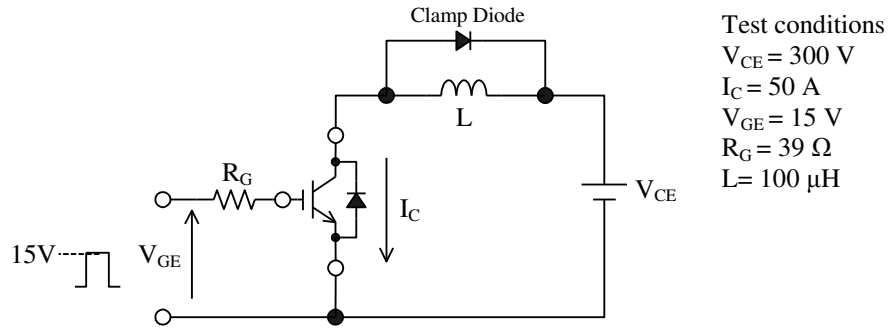

(a) Test Circuit

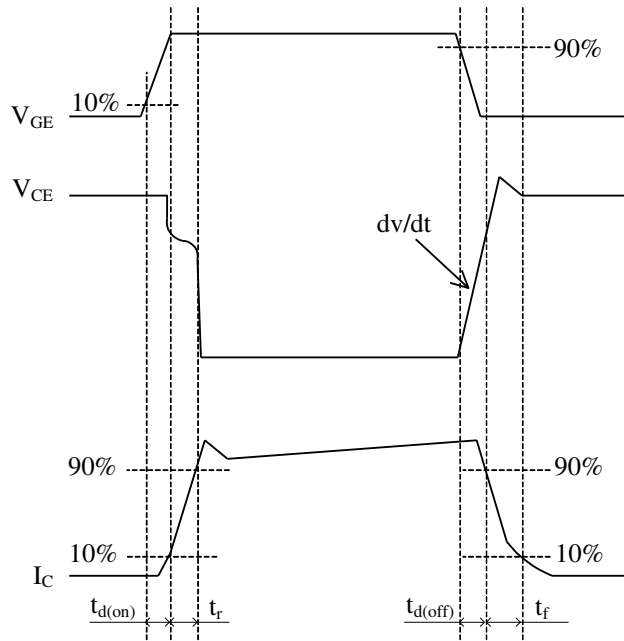

(b) Waveform

Figure 1 Test Circuits and waveforms of dv/dt and Switching Time

Performance Curves

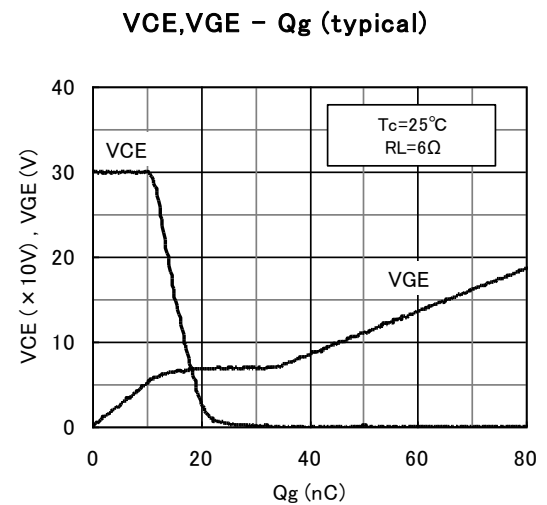
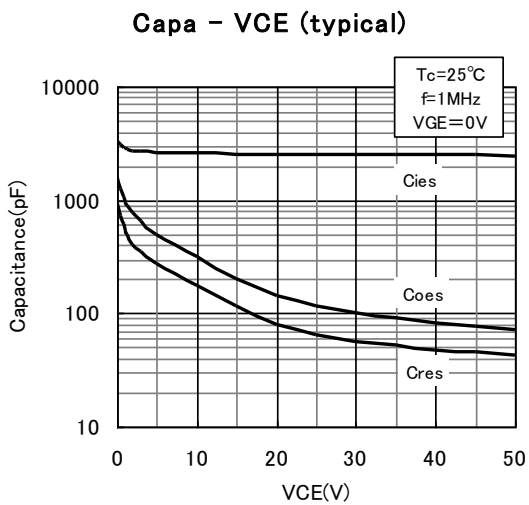
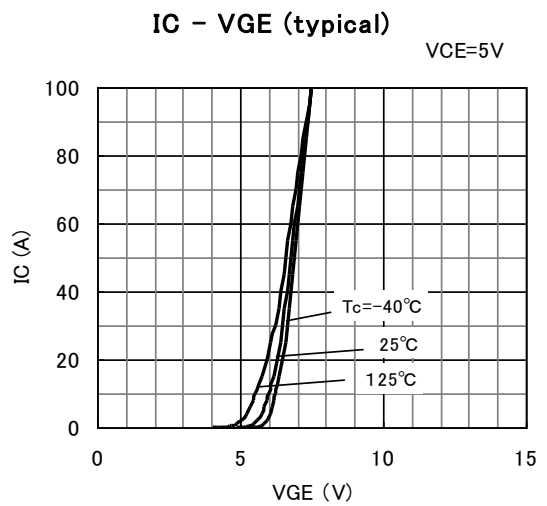
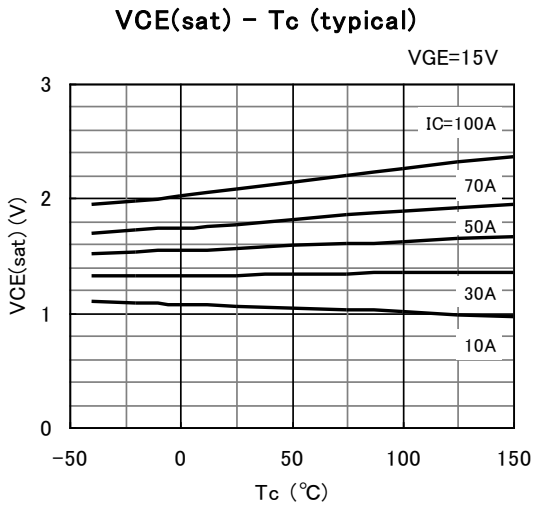
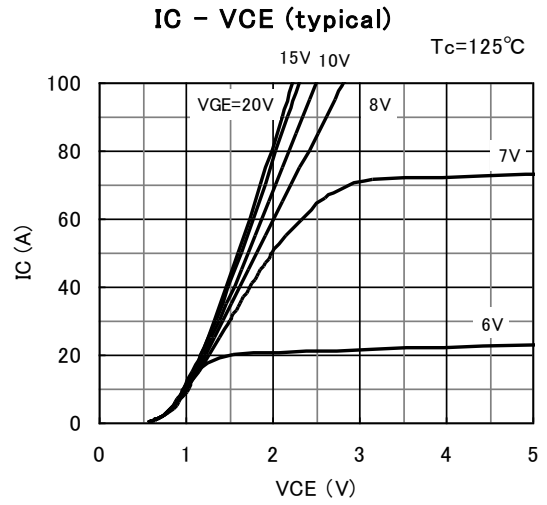
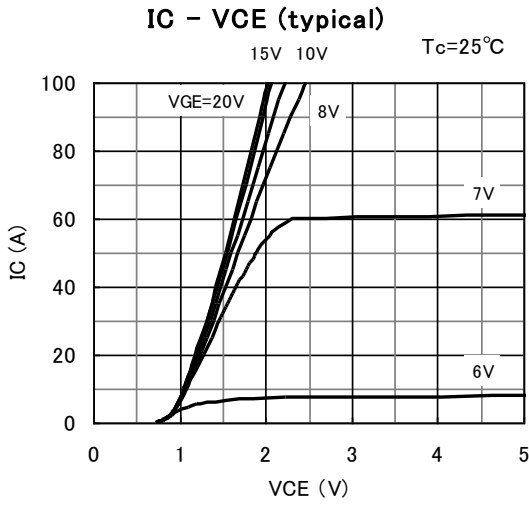

VCE - VGE (typical)

Tc=-40°C

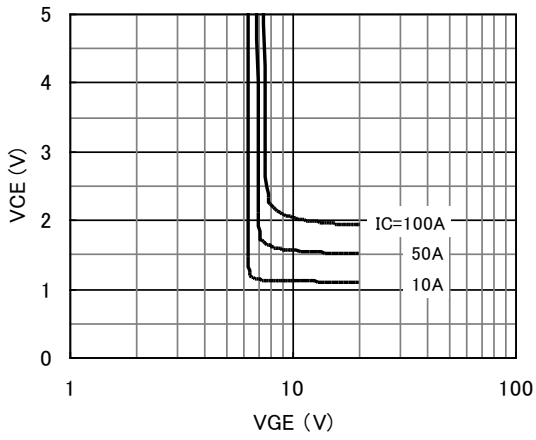

VCE - VGE (typical)

Tc=25°C

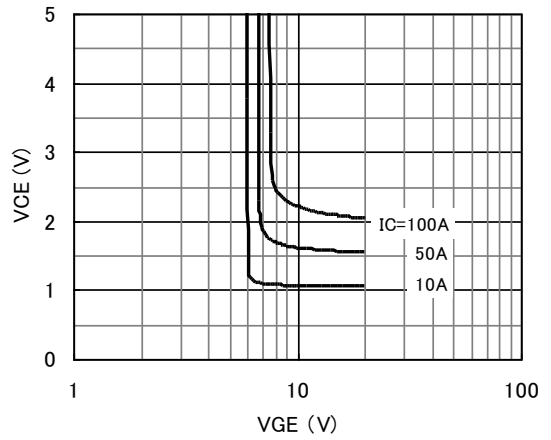

VCE - VGE (typical)

Tc=125°C

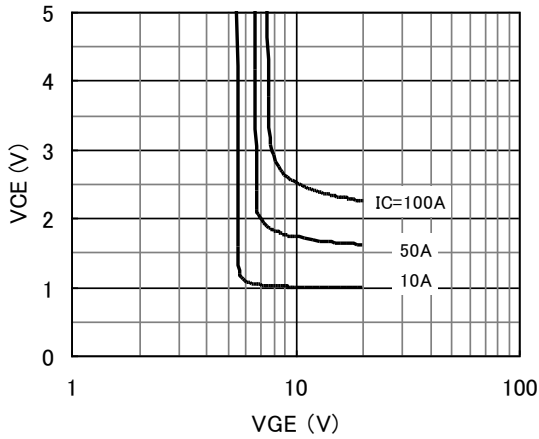

SW Time - IC (typical)

Tc = 25°C

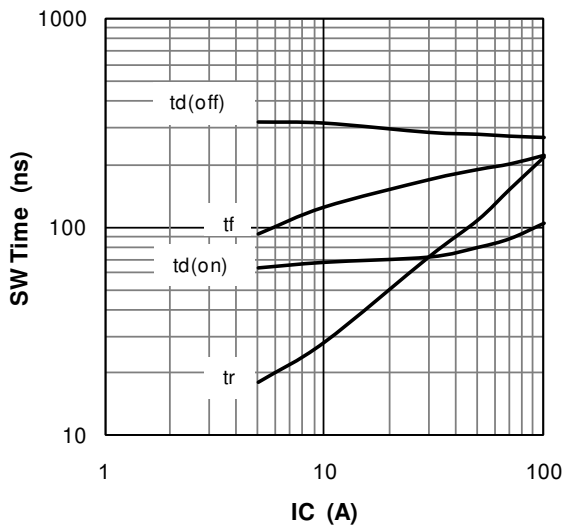

SW Time - IC (typical)

Tc = 125°C

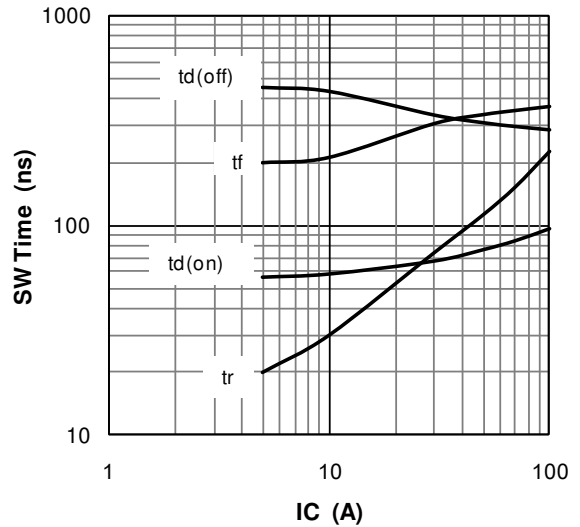

SW Time - RG (typical)

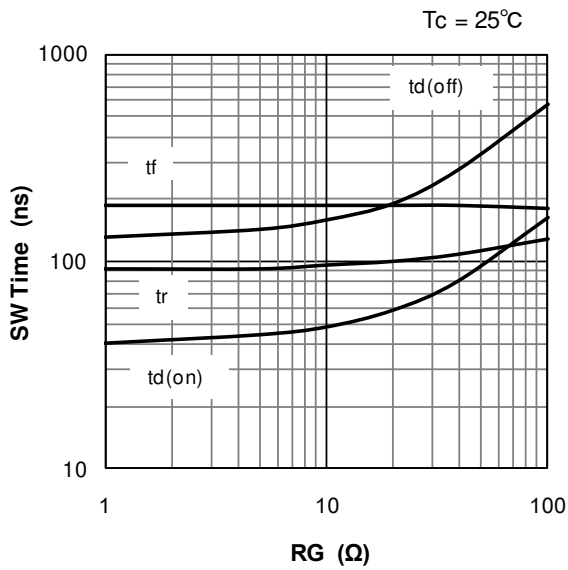

SW Time - RG (typical)

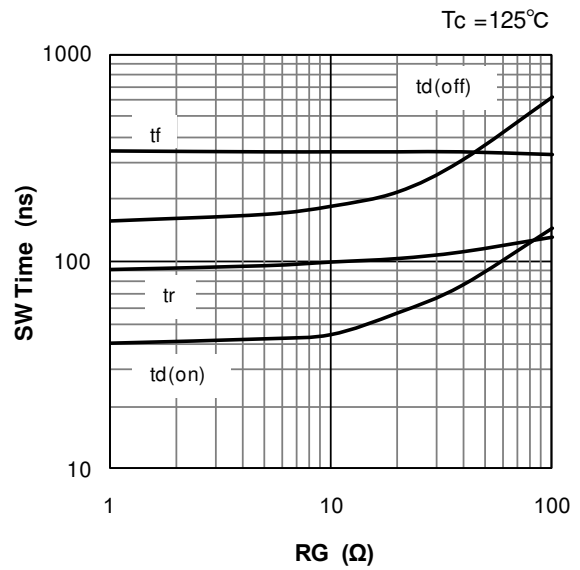

IF - VF (typical)

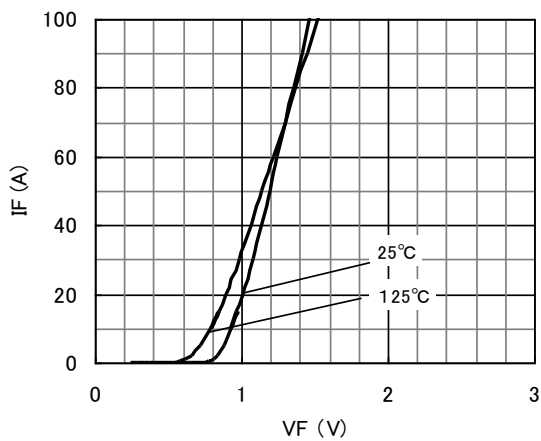

SAFE OPERATING AREA

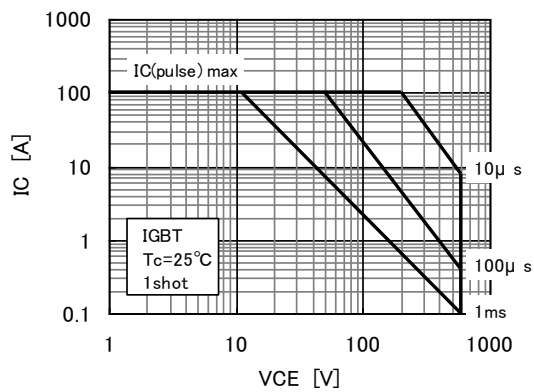

Reverse Bias ASO

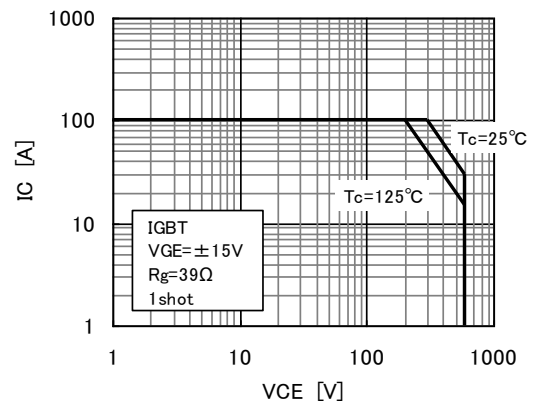

Transient Thermal Resistance of IGBT (pulse width)

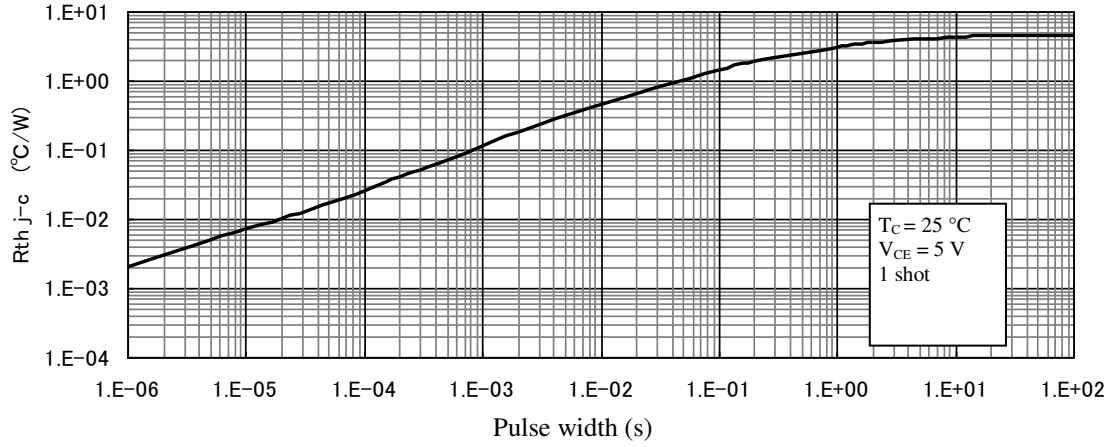

Transient Thermal Resistance of one diode (pulse width)

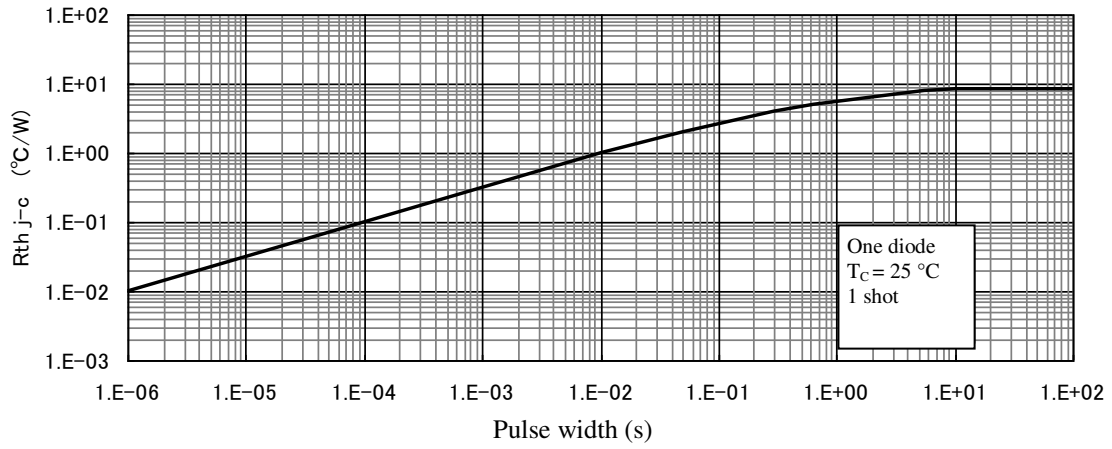

Package Outline

SLA (LF No. 821)

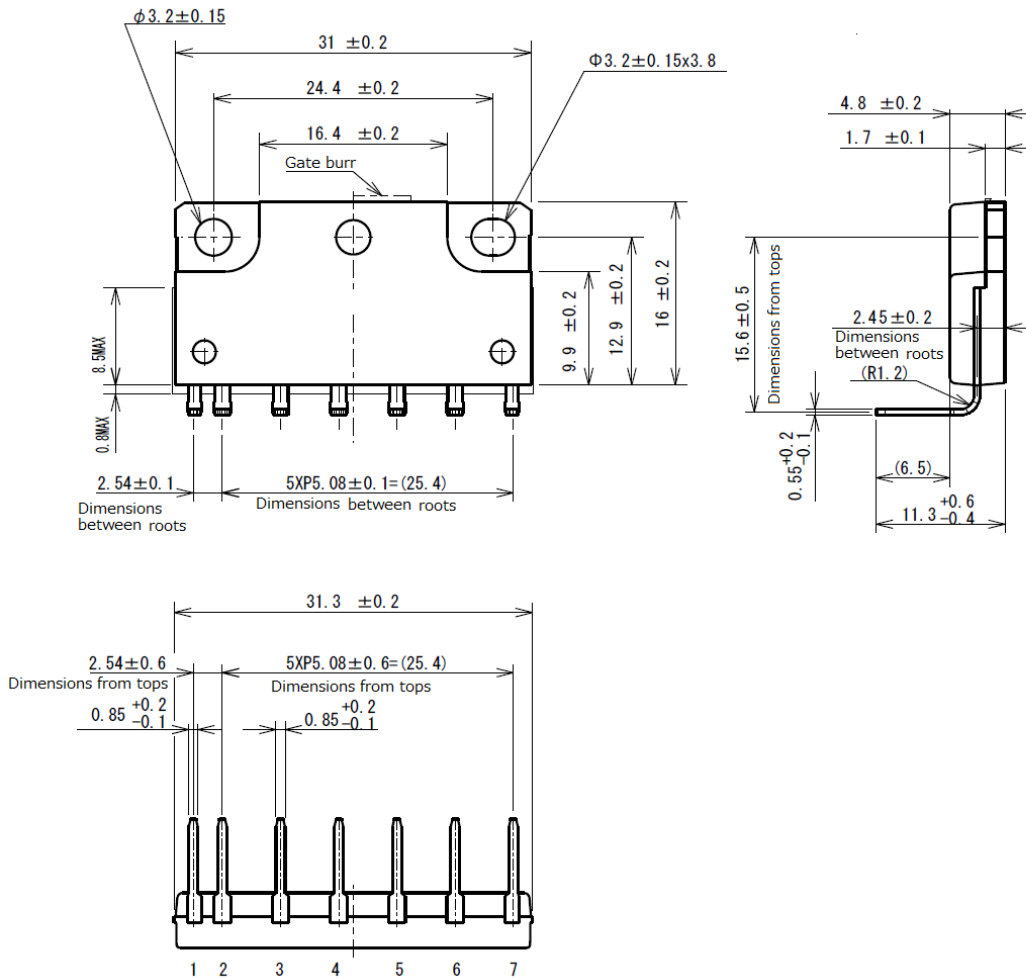

NOTES:

- 1) Dimension is in millimeters
- 2) Pb-free. Device composition compliant with the RoHS directive

Marking Diagram

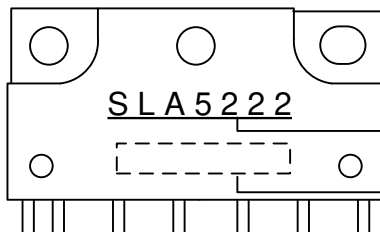

Part Number

Lot Number

Y is the Last digit of year (0 to 9)
 M is the Month (1 to 9, O, N or D)
 DD is the Date (two digit of 01 to 31)

OPERATING PRECAUTIONS

In the case that you use Sanken products or design your products by using Sanken products, the reliability largely depends on the degree of derating to be made to the rated values. Derating may be interpreted as a case that an operation range is set by derating the load from each rated value or surge voltage or noise is considered for derating in order to assure or improve the reliability. In general, derating factors include electric stresses such as electric voltage, electric current, electric power etc., environmental stresses such as ambient temperature, humidity etc. and thermal stress caused due to self-heating of semiconductor products. For these stresses, instantaneous values, maximum values and minimum values must be taken into consideration. In addition, it should be noted that since power devices or IC's including power devices have large self-heating value, the degree of derating of junction temperature affects the reliability significantly.

Because reliability can be affected adversely by improper storage environments and handling methods, please observe the following cautions.

Cautions for Storage

- Ensure that storage conditions comply with the standard temperature (5 to 35°C) and the standard relative humidity (around 40 to 75%); avoid storage locations that experience extreme changes in temperature or humidity.
- Avoid locations where dust or harmful gases are present and avoid direct sunlight.
- Reinspect for rust on leads and solderability of the products that have been stored for a long time.

Cautions for Testing and Handling

When tests are carried out during inspection testing and other standard test periods, protect the products from power surges from the testing device, shorts between the product pins, and wrong connections. Ensure all test parameters are within the ratings specified by Sanken for the products.

Remarks About Using Silicone Grease with a Heatsink

- When silicone grease is used in mounting the products on a heatsink, it shall be applied evenly and thinly. If more silicone grease than required is applied, it may produce excess stress.
- Volatile-type silicone greases may crack after long periods of time, resulting in reduced heat radiation effect. Silicone greases with low consistency (hard grease) may cause cracks in the mold resin when screwing the products to a heatsink.

Our recommended silicone greases for heat radiation purposes, which will not cause any adverse effect on the product life, are indicated below:

Type	Suppliers
G746	Shin-Etsu Chemical Co., Ltd.
YG6260	Momentive Performance Materials Inc.
SC102	Dow Corning Toray Co., Ltd.

Cautions for Mounting to a Heatsink

- When the flatness around the screw hole is insufficient, such as when mounting the products to a heatsink that has an extruded (burred) screw hole, the products can be damaged, even with a lower than recommended screw torque. For mounting the products, the mounting surface flatness should be 0.05mm or less.
- Please select suitable screws for the product shape. Do not use a flat-head machine screw because of the stress to the products. Self-tapping screws are not recommended. When using self-tapping screws, the screw may enter the hole diagonally, not vertically, depending on the conditions of hole before threading or the work situation. That may stress the products and may cause failures.
- Recommended screw torque:

Package	Recommended Screw Torque
TO-220, TO-220F	0.490 to 0.686 N·m (5 to 7 kgf·cm)
TO-3P, TO-3PF, TO-247	0.686 to 0.882 N·m (7 to 9 kgf·cm)
SLA	0.588 to 0.784 N·m (6 to 8 kgf·cm)

- For tightening screws, if a tightening tool (such as a driver) hits the products, the package may crack, and internal stress fractures may occur, which shorten the lifetime of the electrical elements and can cause catastrophic failure. Tightening with an air driver makes a substantial impact. In addition, a screw torque higher than the set torque can be applied and the package may be damaged. Therefore, an electric driver is recommended. When the package is tightened at two or more places, first pre-tighten with a lower torque at all places, then tighten with the specified torque. When using a power driver, torque control is mandatory.
- Please pay special attention about the slack of the press mold. In case that the hole diameter of the heatsink is less

than 4 mm, it may cause the resin crack at tightening.

Soldering

- When soldering the products, please be sure to minimize the working time, within the following limits:
 - 260 ± 5 °C 10 ± 1 s (Flow, 2 times)
 - 380 ± 10 °C 3.5 ± 0.5 s (Soldering iron, 1 time)
- Soldering should be at a distance of at least 1.5 mm from the body of the products.

Electrostatic Discharge

- When handling the products, the operator must be grounded. Grounded wrist straps worn should have at least $1M\Omega$ of resistance from the operator to ground to prevent shock hazard, and it should be placed near the operator.
- Workbenches where the products are handled should be grounded and be provided with conductive table and floor mats.
- When using measuring equipment such as a curve tracer, the equipment should be grounded.
- When soldering the products, the head of soldering irons or the solder bath must be grounded in order to prevent leak voltages generated by them from being applied to the products.
- The products should always be stored and transported in Sanken shipping containers or conductive containers, or be wrapped in aluminum foil.

IMPORTANT NOTES

- The contents in this document are subject to changes, for improvement and other purposes, without notice. Make sure that this is the latest revision of the document before use.
- Application and operation examples described in this document are quoted for the sole purpose of reference for the use of the products herein and Sanken can assume no responsibility for any infringement of industrial property rights, intellectual property rights or any other rights of Sanken or any third party which may result from its use.
- Unless otherwise agreed in writing by Sanken, Sanken makes no warranties of any kind, whether express or implied, as to the products, including product merchantability, and fitness for a particular purpose and special environment, and the information, including its accuracy, usefulness, and reliability, included in this document.
- Although Sanken undertakes to enhance the quality and reliability of its products, the occurrence of failure and defect of semiconductor products at a certain rate is inevitable. Users of Sanken products are requested to take, at their own risk, preventative measures including safety design of the equipment or systems against any possible injury, death, fires or damages to the society due to device failure or malfunction.
- Sanken products listed in this document are designed and intended for the use as components in general purpose electronic equipment or apparatus (home appliances, office equipment, telecommunication equipment, measuring equipment, etc.).
When considering the use of Sanken products in the applications where higher reliability is required (transportation equipment and its control systems, traffic signal control systems or equipment, fire/crime alarm systems, various safety devices, etc.), and whenever long life expectancy is required even in general purpose electronic equipment or apparatus, please contact your nearest Sanken sales representative to discuss, prior to the use of the products herein.
The use of Sanken products without the written consent of Sanken in the applications where extremely high reliability is required (aerospace equipment, nuclear power control systems, life support systems, etc.) is strictly prohibited.
- When using the products specified herein by either (i) combining other products or materials therewith or (ii) physically, chemically or otherwise processing or treating the products, please duly consider all possible risks that may result from all such uses in advance and proceed therewith at your own responsibility.
- Anti radioactive ray design is not considered for the products listed herein.
- Sanken assumes no responsibility for any troubles, such as dropping products caused during transportation out of Sanken's distribution network.
- The contents in this document must not be transcribed or copied without Sanken's written consent.