



Chipsmall Limited consists of a professional team with an average of over 10 year of expertise in the distribution of electronic components. Based in Hongkong, we have already established firm and mutual-benefit business relationships with customers from,Europe,America and south Asia,supplying obsolete and hard-to-find components to meet their specific needs.

With the principle of “Quality Parts,Customers Priority,Honest Operation,and Considerate Service”,our business mainly focus on the distribution of electronic components. Line cards we deal with include Microchip,ALPS,ROHM,Xilinx,Pulse,ON,Everlight and Freescale. Main products comprise IC,Modules,Potentiometer,IC Socket,Relay,Connector.Our parts cover such applications as commercial,industrial, and automotives areas.

We are looking forward to setting up business relationship with you and hope to provide you with the best service and solution. Let us make a better world for our industry!



Contact us

Tel: +86-755-8981 8866 Fax: +86-755-8427 6832

Email & Skype: info@chipsmall.com Web: www.chipsmall.com

Address: A1208, Overseas Decoration Building, #122 Zhenhua RD., Futian, Shenzhen, China



Model No: SLS-P830669
Product Line: Peerless

Rev: 1
Last Update: 2017-04-21 12:39:42

Product Description

The SLS line combines high quality performance with an affordable design. This 12 inch 8 ohm member of the SLS family features a rigid steel basket, a coated paper cone, and a ferrite magnet motor with aluminium shorting ring for improved distortion performance.



Mechanical Drawing

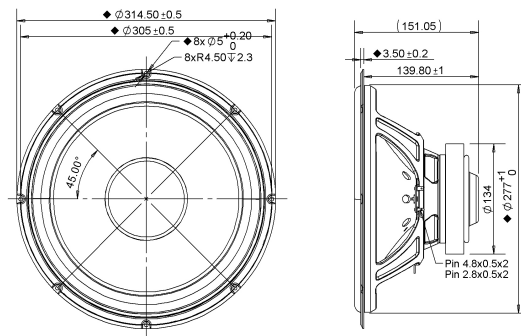

Specifications

DC Resistance	Revc	Ohms	5.6	5.0%	Energy Bandwidth Product	EBP	(1/Qes)*fs
Minimum Impedance	Zmin	Ohms	6.95	7.5%	Moving Mass	Mms	g
Voice Coil Inductance	Le	mH	1.12		Suspension Compliance	Cms	um/N
Resonant Frequency	Fs	Hz	31.48	15%	Effective Cone diameter	D	cm
Mechanical Q Factor	Qms		7.07		Effective Piston Area	Sd	cm ²
Electrical Q Factor	Qes		0.58		Effective Volume	Vas	L
Total Q Factor	Qts		0.54		Motor Force Factor	BL	Tm
Ratio Fs/Qts	F	Fs/Qts	58.51		Motor Efficiency Factor	β	(T*M ²)/Ohms
Half Space Sensitivity @2.83V	db@2.83V/1M	dB	89.85	+/- 1.0db	Voice coil former Material	VCfm	GSV
Half Space Sensitivity @1W/1M	db@1W/1M	dB	89.2	+/- 1.0db	Voice coil inner diameter	VCd	mm
Gap Height	Gh	mm	8		Rated Noise Power	P	W
Maximum Linear Excursion	Xmax	mm	8.3		Test Spectrum Bandwidth		30Hz - 2kHz
Ferrofluid Type	FF				Driver Size	Inch	12 in
Driver Mass	Kg		3.24				

Frequency and Impedance Response

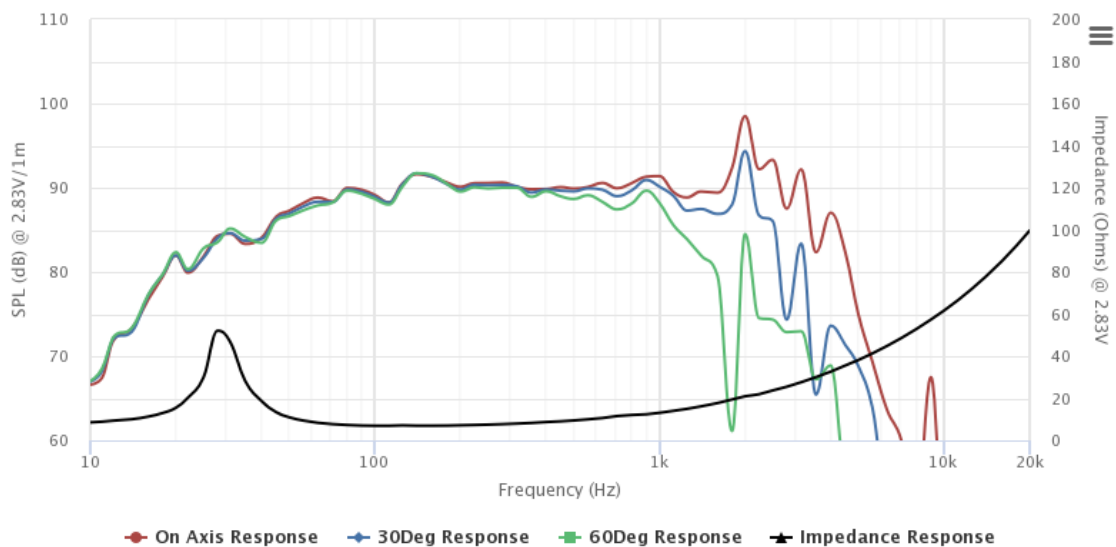

Highcharts.com