



Chipsmall Limited consists of a professional team with an average of over 10 year of expertise in the distribution of electronic components. Based in Hongkong, we have already established firm and mutual-benefit business relationships with customers from,Europe,America and south Asia,supplying obsolete and hard-to-find components to meet their specific needs.

With the principle of “Quality Parts,Customers Priority,Honest Operation,and Considerate Service”,our business mainly focus on the distribution of electronic components. Line cards we deal with include Microchip,ALPS,ROHM,Xilinx,Pulse,ON,Everlight and Freescale. Main products comprise IC,Modules,Potentiometer,IC Socket,Relay,Connector.Our parts cover such applications as commercial,industrial, and automotives areas.

We are looking forward to setting up business relationship with you and hope to provide you with the best service and solution. Let us make a better world for our industry!



## Contact us

Tel: +86-755-8981 8866 Fax: +86-755-8427 6832

Email & Skype: info@chipsmall.com Web: www.chipsmall.com

Address: A1208, Overseas Decoration Building, #122 Zhenhua RD., Futian, Shenzhen, China



## PROTECTION PRODUCTS

### Description

The SLV series of transient voltage suppressors are designed to protect low voltage, state-of-the-art CMOS semiconductors from transients caused by electrostatic discharge (ESD), cable discharge events (CDE), lightning and other induced voltage surges.

The devices are constructed using Semtech's proprietary EPD process technology. The EPD process provides low standoff voltages with significant reductions in leakage currents and capacitance over silicon-avalanche diode processes. The SLVE2.8 and SLVG2.8 are in a SOT-143 package and have a low 2.8V working voltage. They may be used to protect one line in differential or common mode. The "flow-thru" design minimizes trace inductance and reduces voltage overshoot associated with ESD events.

The SLV is specifically designed to protect low voltage components such as Ethernet transceivers, laser diodes, ASICs, and high-speed RAM. The low clamping voltage of the SLV minimizes the stress on the protected IC.

The SLV series TVS diodes will exceed the surge requirements of IEC 61000-4-2, Level 4.

### Features

- ◆ 300 Watts peak pulse power ( $t_p = 8/20\mu s$ )
- ◆ Transient protection for low voltage data lines to **IEC 61000-4-2 (ESD)  $\pm 15kV$  (air),  $\pm 8kV$  (contact)**  
**IEC 61000-4-4 (EFT) 40A (5/50ns)**  
**IEC 61000-4-5 (Lightning) 24A (8/20 $\mu s$ )**
- ◆ Protects one line
- ◆ Comprehensive pin out for easy board layout
- ◆ Low capacitance
- ◆ Low leakage current
- ◆ Low operating and clamping voltages
- ◆ Solid-state EPD TVS process technology

### Mechanical Characteristics

- ◆ JEDEC SOT-143 package
- ◆ Molding compound flammability rating: UL 94V-0
- ◆ Marking : Marking code
- ◆ Packaging : Tape and Reel per EIA 481

### Applications

- ◆ ESD and Latch-up Protection
- ◆ Analog Inputs
- ◆ WAN/LAN Equipment
- ◆ Low Voltage ASICs
- ◆ Desktops, Servers, Notebooks and Handhelds
- ◆ Portable Instrumentation
- ◆ Base Stations
- ◆ Laser Diode Protection

### Schematic & Pin Configuration

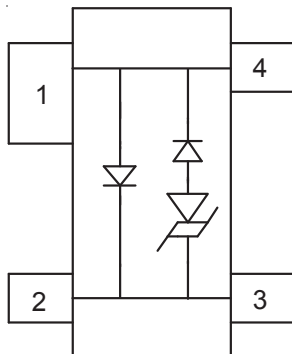

**SLVG2.8 (Top View)**

### Schematic & PIN Configuration

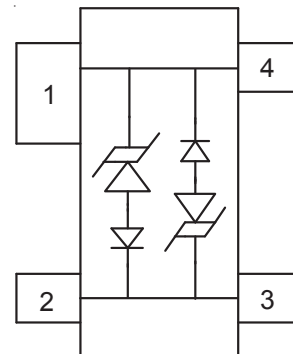

**SLVE2.8 (Top View)**

**PROTECTION PRODUCTS**
**Absolute Maximum Rating**

Rating	Symbol	Value	Units
Peak Pulse Power ( $t_p = 8/20\mu s$ )	$P_{pk}$	300	Watts
Peak Pulse Current ( $t_p = 8/20\mu s$ )	$I_{pp}$	24	A
Lead Soldering Temperature	$T_L$	260 (10 seconds)	°C
Operating Temperature	$T_J$	-55 to +125	°C
Storage Temperature	$T_{STG}$	-55 to +150	°C

**Electrical Characteristics**

<b>SLVE2.8</b>						
Parameter	Symbol	Conditions	Minimum	Typical	Maximum	Units
Reverse Stand-Off Voltage	$V_{RWM}$				2.8	V
Punch-Through Voltage	$V_{PT}$	$I_{PT} = 2\mu A$	3.0			V
Snap-Back Voltage	$V_{SB}$	$I_{SB} = 50mA$	2.8			V
Reverse Leakage Current	$I_R$	$V_{RWM} = 2.8V, T=25^\circ C$			1	$\mu A$
Clamping Voltage	$V_C$	$I_{pp} = 1A, t_p = 8/20\mu s$			4.1	V
Clamping Voltage	$V_C$	$I_{pp} = 5A, t_p = 8/20\mu s$			5.3	V
Clamping Voltage	$V_C$	$I_{pp} = 24A, t_p = 8/20\mu s$			15	V
Junction Capacitance	$C_j$	Line-to-Line $V_R = 0V, f = 1MHz$			100	pF

<b>SLVG2.8</b>						
Parameter	Symbol	Conditions	Minimum	Typical	Maximum	Units
Reverse Stand-Off Voltage	$V_{RWM}$				2.8	V
Punch-Through Voltage	$V_{PT}$	$I_{PT} = 2\mu A$	3.0			V
Snap-Back Voltage	$V_{SB}$	$I_{SB} = 50mA$	2.8			V
Reverse Leakage Current	$I_R$	$V_{RWM} = 2.8V, T=25^\circ C$			1	$\mu A$
Clamping Voltage	$V_C$	$I_{pp} = 1A, t_p = 8/20\mu s$			4.1	V
Clamping Voltage	$V_C$	$I_{pp} = 5A, t_p = 8/20\mu s$			5.3	V
Clamping Voltage	$V_C$	$I_{pp} = 24A, t_p = 8/20\mu s$			15	V
Junction Capacitance	$C_j$	Line-to-Line $V_R = 0V, f = 1MHz$			50	pF

## PROTECTION PRODUCTS

### Typical Characteristics

#### Non-Repetitive Peak Pulse Power vs. Pulse Time

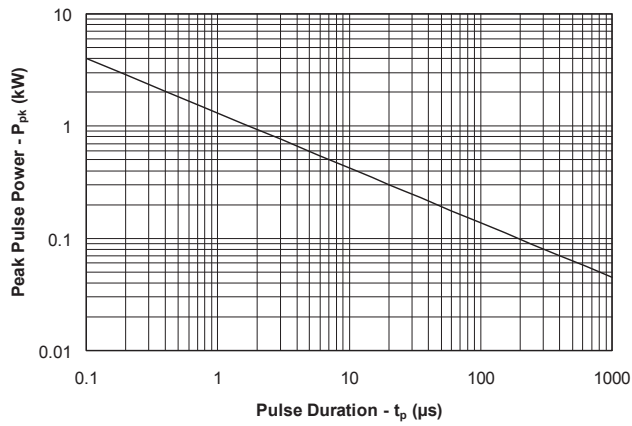

#### Power Derating Curve

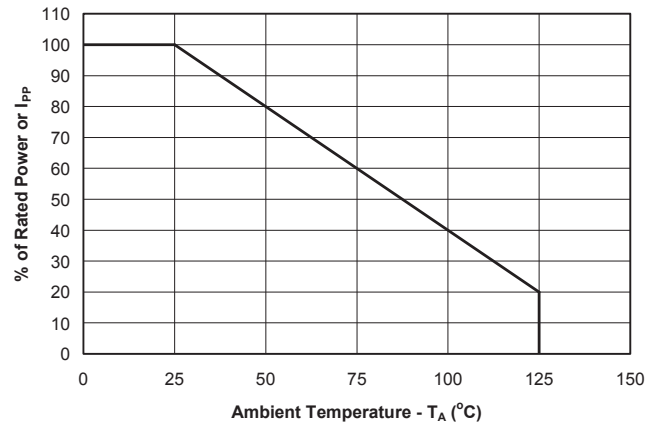

#### Pulse Waveform

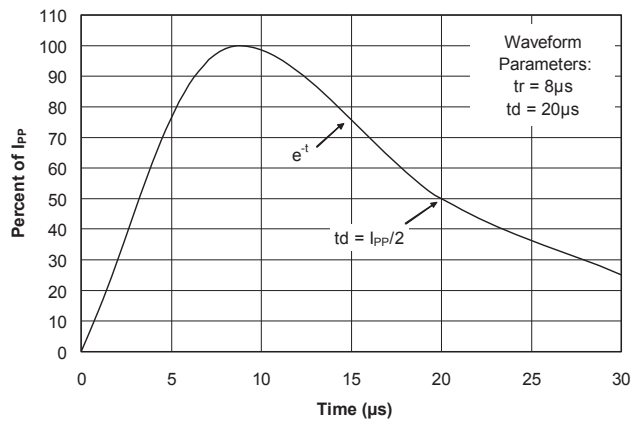

#### Clamping Voltage vs. Peak Pulse Current

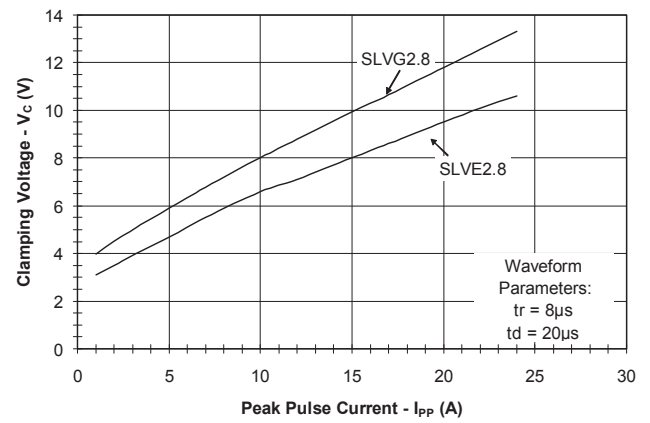

## PROTECTION PRODUCTS

### Applications Information

#### Device Connection

Electronic equipment is susceptible to transient disturbances from a variety of sources including: ESD to an open connector or interface, direct or nearby lightning strikes to cables and wires, and charged cables “hot plugged” into I/O ports. The SLV series is designed to protect sensitive components from damage and latch-up which may result from such transient events. The SLVG2.8 is designed to protect one unidirectional line while the SLVE2.8 is designed to protect one bidirectional line (or two differential lines). The options for connecting the devices are as follows:

- **SLVE2.8:** Common mode protection of one bidirectional data line is achieved by connecting the data line input/output at pins 2 and 3. Pins 1 and 4 are connected to ground. For differential protection, pins 1 and 4 can be connected to a second I/O line. For best results, the ground connection should be made directly to a ground plane on the board. The path length should be kept as short as possible to minimize parasitic inductance.
- **SLVG2.8:** Common mode protection of one unidirectional line is achieved by connecting the line to be protected at pins 2 and 3. Pins 1 and 4 are connected to ground. For best results, the ground connection should be made directly to a ground plane on the board. The path length should be kept as short as possible to minimize parasitic inductance.

#### Circuit Board Layout Recommendations for Suppression of ESD.

Good circuit board layout is critical for the suppression of ESD induced transients. The following guidelines are recommended:

- Place the TVS near the input terminals or connectors to restrict transient coupling.
- Minimize the path length between the TVS and the protected line.
- Minimize all conductive loops including power and ground loops.
- The ESD transient return path to ground should be kept as short as possible.
- Never run critical signals near board edges.
- Use ground planes whenever possible.

#### Circuit Diagrams

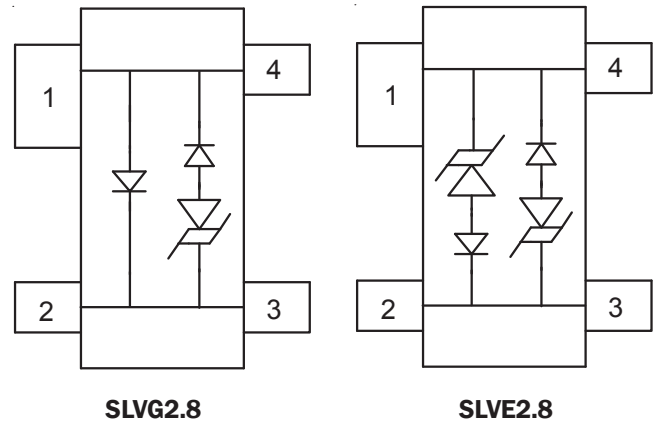

#### Common Mode Protection (SLVE2.8 and SLVG2.8)

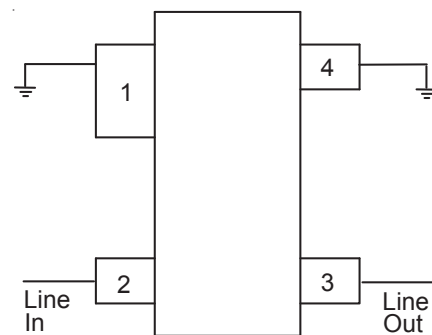

#### Differential Mode Protection (SLVE2.8 only)

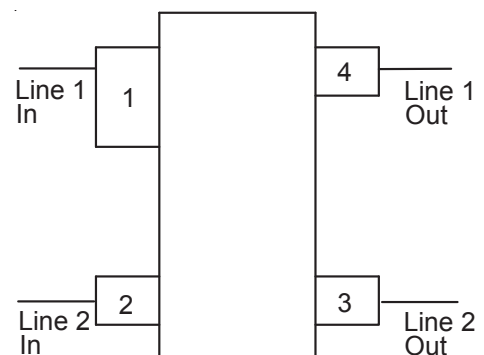

## PROTECTION PRODUCTS

### Applications Information (continued)

#### EPD TVS™ Characteristics

The SLV series is constructed using Semtech’s proprietary EPD technology. The structure of the EPD TVS is vastly different from the traditional pn-junction devices. At voltages below 5V, high leakage current and junction capacitance render conventional avalanche technology impractical for most applications. However, by utilizing the EPD technology, the SLVE2.8 and SLVG2.8 can effectively operate at 2.8V while maintaining excellent electrical characteristics.

The EPD TVS employs a complex npn structure in contrast to the pn structure normally found in traditional silicon-avalanche TVS diodes. The EPD mechanism is achieved by engineering the center region of the device such that the reverse biased junction does not avalanche, but will “punch-through” to a conducting state. This structure results in a device with superior dc electrical parameters at low voltages while maintaining the capability to absorb high transient currents.

The IV characteristic curve of the EPD device is shown in Figure 1. The device represents a high impedance to the circuit up to the working voltage ( $V_{RWM}$ ). During a transient event, the device will begin to conduct as it is biased in the reverse direction. When the punch-through voltage ( $V_{PT}$ ) is exceeded, the device enters a low impedance state, diverting the transient current away from the protected circuit. When the device is conducting current, it will exhibit a slight “snap-back” or negative resistance characteristic due to its structure. This must be considered when connecting the device to a power supply rail. To return to a non-conducting state, the current through the device must fall below the snap-back current (approximately < 50mA).

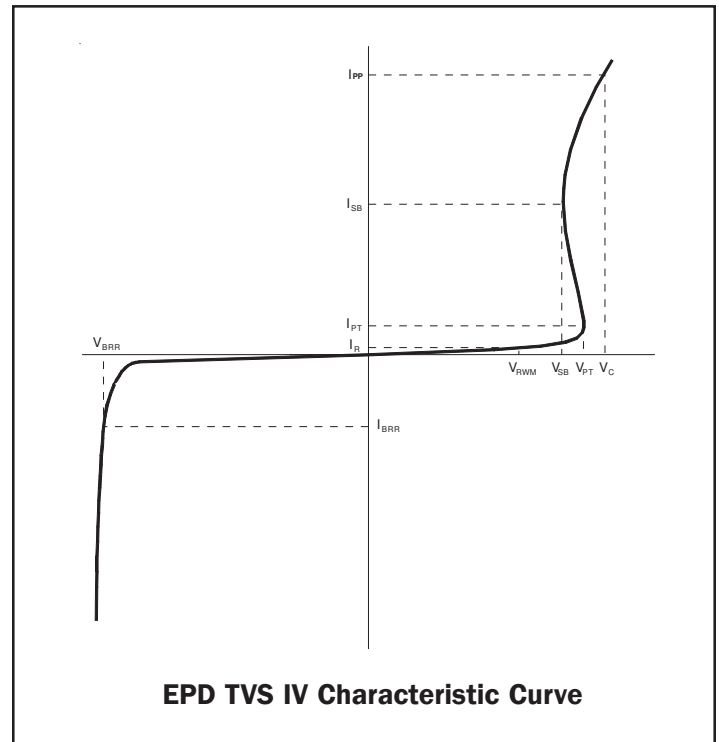

**EPD TVS IV Characteristic Curve**

## PROTECTION PRODUCTS

### Outline Drawing - SOT-143

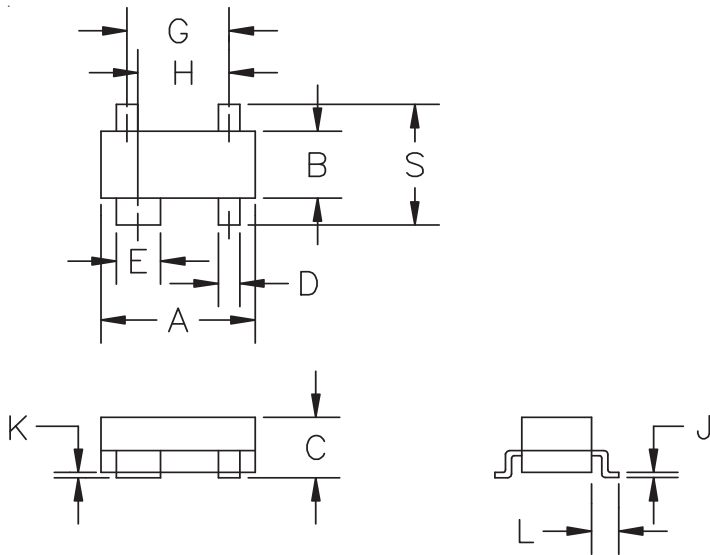

DIM <sup>N</sup>	INCHES		MM		NOTE
	MIN	MAX	MIN	MAX	
A	.110	.120	2.80	3.04	—
B	.047	.055	1.20	1.40	—
C	.031	.047	.800	1.20	—
D	.014	.018	.370	.460	—
E	.030	.035	.760	.890	—
G	.076	BSC	1.92	BSC	—
H	.068	BSC	1.72	BSC	—
J	.003	.007	.085	.180	—
K	.001	.004	.013	0.10	—
L	—	.022	—	.55	REF
S	.082	.104	2.10	2.64	—

**Notes:**

- (1) Controlling dimension: Millimeters.
- (2) Dimension A and B do not include mold protrusions. Mold protrusions are .006" max.

### Land Pattern - SOT-143

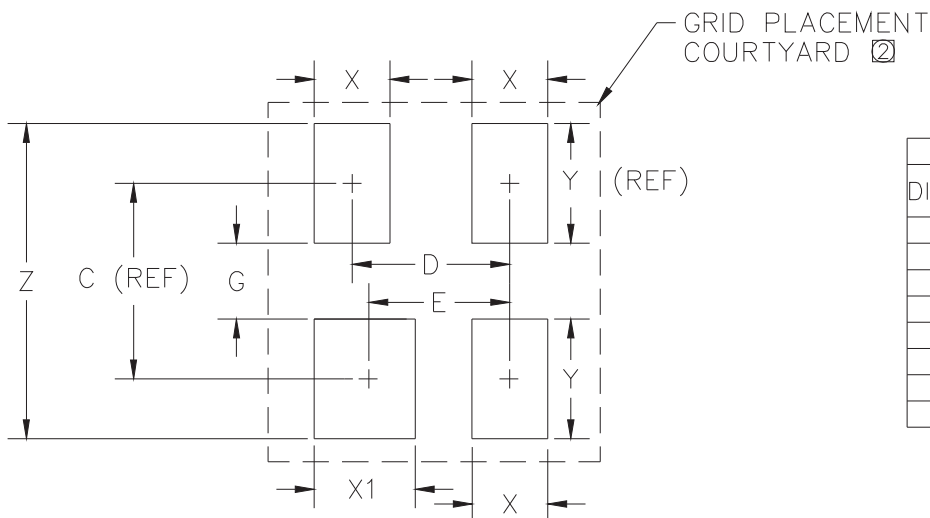

DIM <sup>N</sup>	INCHES		MM		NOTE
	MIN	MAX	MIN	MAX	
C	—	.087	—	2.20	—
D	.075	BSC	1.90	BSC	—
E	.067	BSC	1.70	BSC	—
G	.032	.040	.80	1.00	—
X	.032	.040	.80	1.00	—
X1	.040	.048	1.00	1.20	—
Y	—	.055	—	1.40	—
Z	.134	.140	3.40	3.60	—

- ② GRID PLACEMENT COURTYARD IS 8 X 8 ELEMENTS (4mm X 4mm) IN ACCORDANCE WITH THE INTERNATIONAL GRID DETAILED IN IEC PUBLICATION 97.
- ① CONTROLLING DIMENSION: MILLIMETERS.

**PROTECTION PRODUCTS****Marking Codes**

<b>Part Number</b>	<b>Marking Code</b>
SLVE2.8	E2.8
SLVG2.8	G2.8

**Ordering Information**

<b>Part Number</b>	<b>Working Voltage</b>	<b>Qty per Reel</b>	<b>Reel Size</b>
SLVE2.8.TC	2.8V	3,000	7 Inch
SLVG2.8.TC	2.8V	3,000	7 Inch

**Note: Consult factory for availability of 13" reels**

**Contact Information**

Semtech Corporation  
Protection Products Division  
200 Flynn Road, Camarillo, CA 93012  
Phone: (805)498-2111 FAX (805)498-3804