



Chipsmall Limited consists of a professional team with an average of over 10 year of expertise in the distribution of electronic components. Based in Hongkong, we have already established firm and mutual-benefit business relationships with customers from,Europe,America and south Asia,supplying obsolete and hard-to-find components to meet their specific needs.

With the principle of “Quality Parts,Customers Priority,Honest Operation,and Considerate Service”,our business mainly focus on the distribution of electronic components. Line cards we deal with include Microchip,ALPS,ROHM,Xilinx,Pulse,ON,Everlight and Freescale. Main products comprise IC,Modules,Potentiometer,IC Socket,Relay,Connector.Our parts cover such applications as commercial,industrial, and automotives areas.

We are looking forward to setting up business relationship with you and hope to provide you with the best service and solution. Let us make a better world for our industry!



Contact us

Tel: +86-755-8981 8866 Fax: +86-755-8427 6832

Email & Skype: info@chipsmall.com Web: www.chipsmall.com

Address: A1208, Overseas Decoration Building, #122 Zhenhua RD., Futian, Shenzhen, China



DIGITAL I/O MODULES

0.6 INCH, M, SM OUTPUT MODULES



FEATURES:

- CE Compliant
- Available in three physical configurations
- UL Recognized (E46203) / CSA Certified (38595)
- 4 kV Optical Isolation

0.6" SERIES

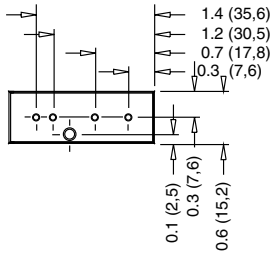
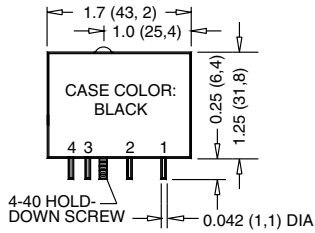

M SERIES

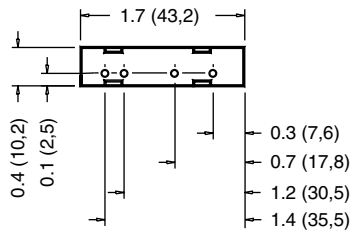
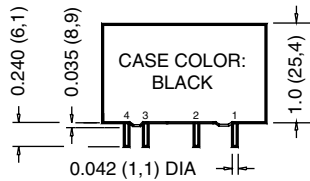

SM SERIES

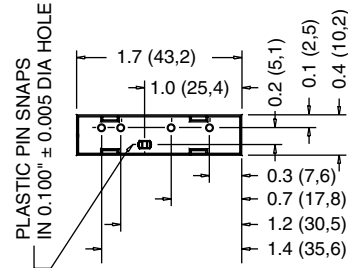
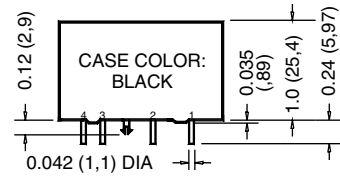

DIMENSIONS: INCHES (MILLIMETERS)
TOLERANCE: ±0.020 (±0.50)

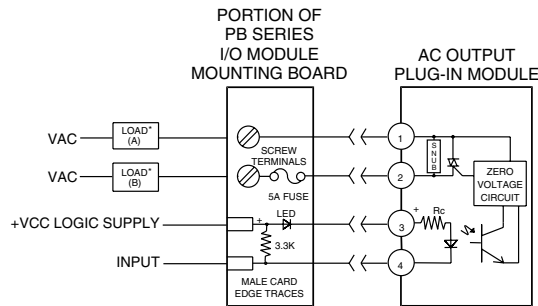

* LOAD MAY BE WIRED IN LOCATION A OR B

Products and specifications subject to change without notice.
Consult factory for application assistance.

DIGITAL I/O MODULES

0.6 INCH, M, SM OUTPUT MODULES

INPUT SPECIFICATIONS: (1)

Model Number	OACU OACUA OACUAH MOACU MOACUA MOACUAH	SMOACU SMOACUA SMOACUAH	Units
Nominal Voltage		15	VDC
Minimum Voltage (2)		3	VDC
Maximum Voltage		15	VDC
Drop-Out Voltage		1	VDC
Maximum Current (3)		44	mA
Resistance (4)		360	Ohms

OUTPUT SPECIFICATIONS: (1)

Model Number	OACU MOACU SMOACU	OACUA MOACUA SMOACUA	OACUAH MOACUAH SMOACUAH
Nominal Line Voltage	120 VAC	240 VAC	240 VAC
Minimum Line Voltage	12 VAC	24 VAC	24 VAC
Maximum Line Voltage	140 VAC	280 VAC	280 VAC
Max Off-State Voltage (5)	400 Vpeak	600 Vpeak	600 Vpeak
Max Off-State Leakage (6)	1.75 mA	1.75 mA	1.75 mA
Static Off-State dv/dt (7)	200 V / μ sec	200 V / μ sec	200 V / μ sec
Maximum Rated On-State Current (8)	3.5 Arms	3.5 Arms	5.0 Arms
Minimum On-State Current	50 mArms	50 mArms	50 mArms
Maximum Surge Current (9)	100 Apeak	100 Apeak	250 Apeak
On-State Voltage Drop or Resistance (10)	1.6 V	1.6 V	1.6 V
H.P. Rating (13)	1/4 H.P.	1/4 H.P.	

GENERAL SPECIFICATIONS: (1)

Model Number	OACU OACUA OACUAH	MOACU MOACUA MOACUAH	SMOACU SMOACUA SMOACUAH	Units
Operating Temperature Range		-30 to 80		°C
Storage Temperature Range		-40 to 100		°C
Maximum Turn-on Time (11)		8.33		mSec
Maximum Turn-off Time (11)		8.33		mSec
Input/Output Isolation Voltage (12)		4000		VAC
Input/Output Capacitance (typical)		8		pF
Line Frequency Range		47 to 63		Hertz

TABLE OF MODEL NUMBER SUFFIXES IDENTIFYING OPTIONAL FEATURES

Suffix Feature

Notes:

- (1) Specifications apply to an ambient temperature of -30 to 80°C unless otherwise noted.
- (2) Without external LED status indicator. Add 1.7 volt for external LED if utilized.
- (3) At nominal input voltage, without external LED status indicator.
- (4) +/-10% at 25°C.
- (5) Maximum 1 minute duration for OAC modules when applied as a DC voltage rather than peak AC voltage.
- (6) At maximum line voltage, 25°C for OAC modules.
- (7) Minimum dv/dt per EIA/NARM RS443, method RS397.
- (8) At 40°C, derate OAC modules by 58 mA/°C to 80°C. CSA rating of OAC modules is 3.0 Arms at 40°C.
- (9) At 25°C. Maximum duration: 1 AC cycle for OAC modules.
- (10) At maximum rated on-state current and 25°C.
- (11) At maximum line voltage, maximum rated output current, nominal input voltage, 25°C. Switching speed of OAC modules based upon 60 Hz line frequency.
- (12) At 25°C for 1 second maximum duration.
- (13) 1/4 H.P. at 240 VAC, 1/8 H.P. at 120 VAC.

Products and specifications subject to change without notice.
Consult factory for application assistance.