



Chipsmall Limited consists of a professional team with an average of over 10 year of expertise in the distribution of electronic components. Based in Hongkong, we have already established firm and mutual-benefit business relationships with customers from,Europe,America and south Asia,supplying obsolete and hard-to-find components to meet their specific needs.

With the principle of “Quality Parts,Customers Priority,Honest Operation,and Considerate Service”,our business mainly focus on the distribution of electronic components. Line cards we deal with include Microchip,ALPS,ROHM,Xilinx,Pulse,ON,Everlight and Freescale. Main products comprise IC,Modules,Potentiometer,IC Socket,Relay,Connector.Our parts cover such applications as commercial,industrial, and automotives areas.

We are looking forward to setting up business relationship with you and hope to provide you with the best service and solution. Let us make a better world for our industry!



Contact us

Tel: +86-755-8981 8866 Fax: +86-755-8427 6832

Email & Skype: info@chipsmall.com Web: www.chipsmall.com

Address: A1208, Overseas Decoration Building, #122 Zhenhua RD., Futian, Shenzhen, China



SURFACE MOUNT LED WHITE, 2835 PACKAGE, 0.2W



SM2835UWDX02

- ◆ Industry Standard 2835 Package
- ◆ RoHS Compliant
- ◆ Small Package and Footprint
- ◆ X - (C) Cool White, (N) Neutral White, (W) Warm White
- ◆ Wide Viewing Angle
- ◆ Ideal for Lighting and Backlighting Application

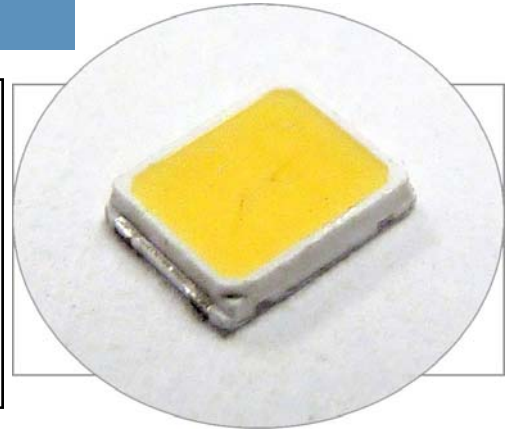

Bivar Surface Mount 2835 package LED may be used in nearly any lighting or backlighting application. These 0.2 Watt SMD LED's have a minimum CRI Value of 80 and are available in 3 color temperatures to meet any illumination needs: Cool, Neutral and Warm White. The SM2835 Series is conveniently packaged in standard tape and reels for pick and place assemblies.

Part Number	Material	Emitted Color	Lens Color	Luminous Flux (lm) TYP.	Viewing Angle
SM2835UWDC02	InGaN	Cool White	Diffused	24	120°
SM2835UWDN02	InGaN	Neutral White	Diffused	23	120°
SM2835UWDW02	InGaN	Warm White	Diffused	22	120°

Outline Dimensions

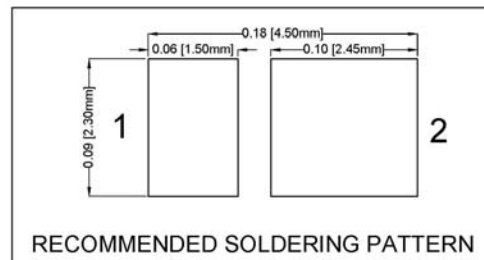
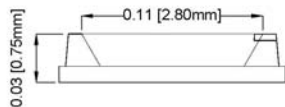
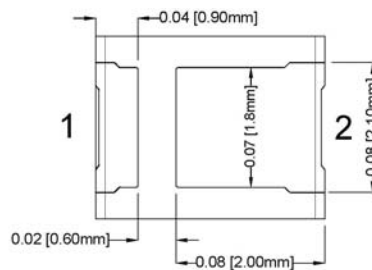
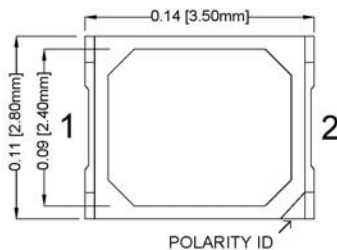

Outline Drawings Notes:

1. All dimensions are in inches [millimeters].
2. Standard tolerance: ± 0.010 " unless otherwise noted.



Bivar reserves the right to make changes at any time without notice.

Absolute Maximum Ratings

$T_A = 25^\circ\text{C}$ unless otherwise noted

Power Dissipation	0.26 W
Forward Current (DC)	75 mA
Peak Forward Current ¹	120 mA
Reverse Voltage	5 V
Electrostatic Discharge (HBM)	2000 V
Operating Temperature Range	-40 ~ +100°C
Storage Temperature Range	-40 ~ +100°C
Junction Temperature	115°C
Lead Soldering Temperature ²	260°C

- Notes: 1. $\leq 10\%$ Duty Cycle, Pulse Width ≤ 0.1 msec.
2. Solder time less than 5 seconds at temperature extreme.

Electrical / Optical Characteristics

$T_A = 25^\circ\text{C}$ & $I_F = 60$ mA unless otherwise noted

Part Number	Forward Voltage (V)			Recommend Forward Current (mA)	Reverse Current (μA) $V_R=5\text{V}$	CCT (Kelvin)			Luminous Flux (lm)			Viewing Angle $2\theta_{1/2}$ (deg)
	MIN	TYP	MAX	TYP	MAX	MIN	TYP	MAX	MIN	TYP	MAX	TYP
SM2835UWDC02	2.9	/	3.5	60	10	5800	6500	7300	20	24	28	120
SM2835UWDN02	2.9	/	3.5	60	10	3700	4000	4400	20	23	28	120
SM2835UWDW02	2.9	/	3.5	60	10	2750	3000	3150	20	22	26	120

- Notes: 1. The above forward voltage measurement allowance tolerance is $\pm 0.1\text{V}$.
2. The above luminous flux measurement allowance tolerance $\pm 10\%$.

SURFACE MOUNT LED WHITE, 2835 PACKAGE, 0.2W



Typical Electrical / Optical Characteristics

$T_A = 25^\circ\text{C}$ unless otherwise noted

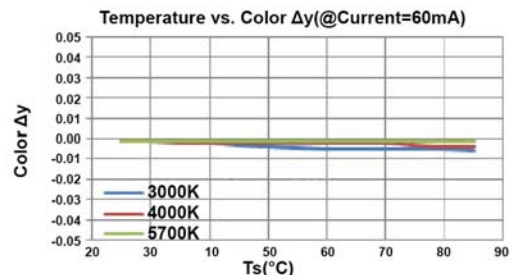
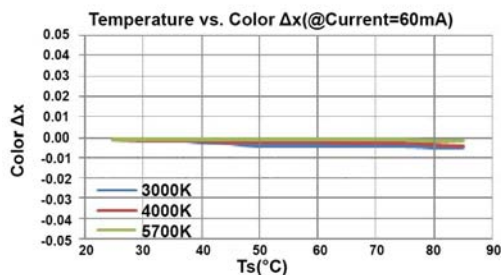
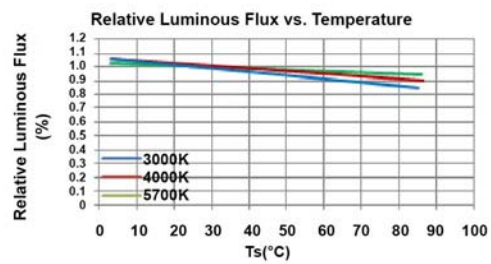
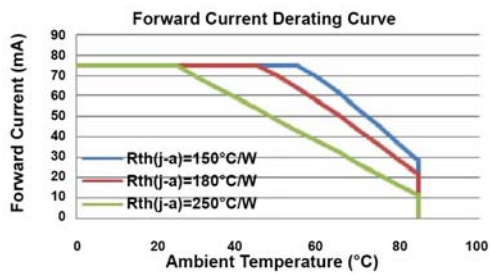
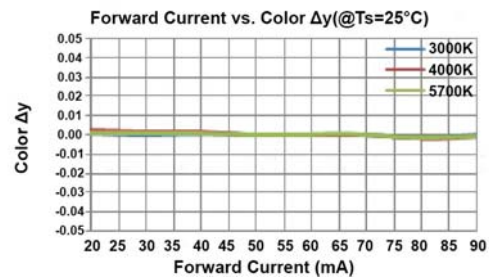
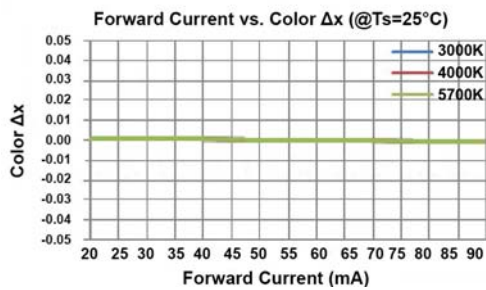
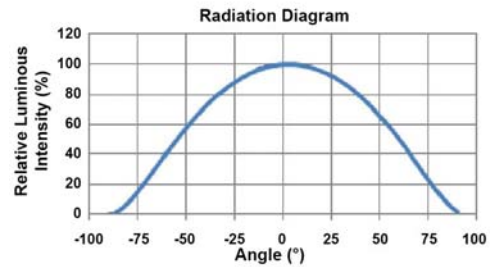
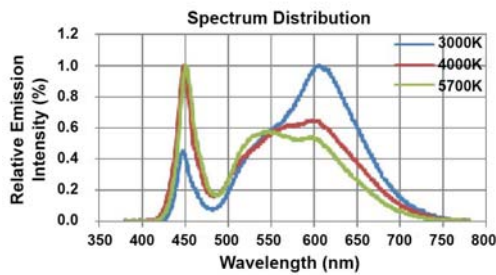
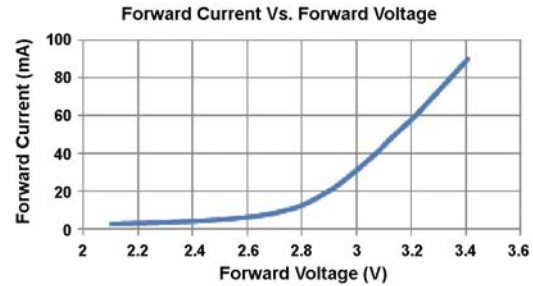
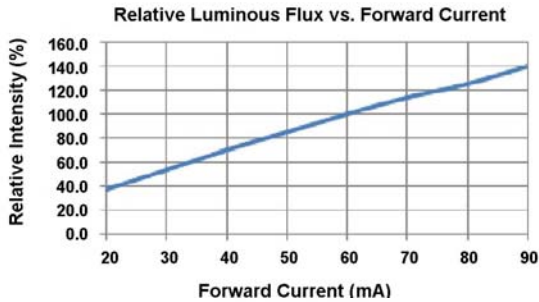

Bivar reserves the right to make changes at any time without notice.

SURFACE MOUNT LED WHITE, 2835 PACKAGE, 0.2W



Recommended Soldering Conditions

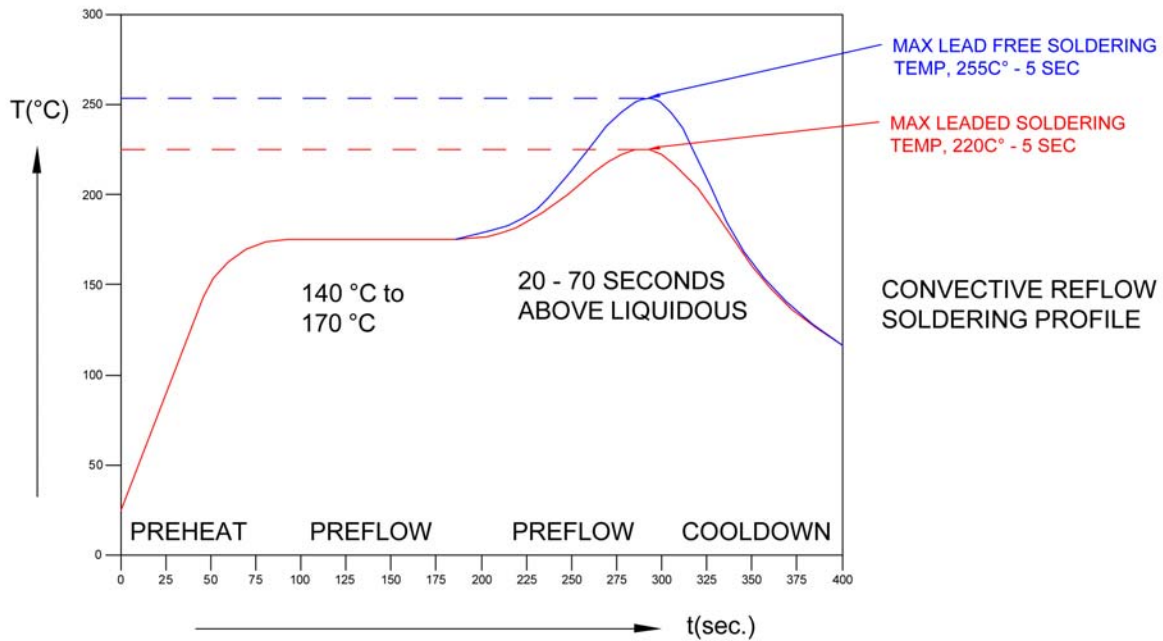

Tape and Reel Dimensions

Note: 4000 pcs/Reel

• Dimensions of Tape

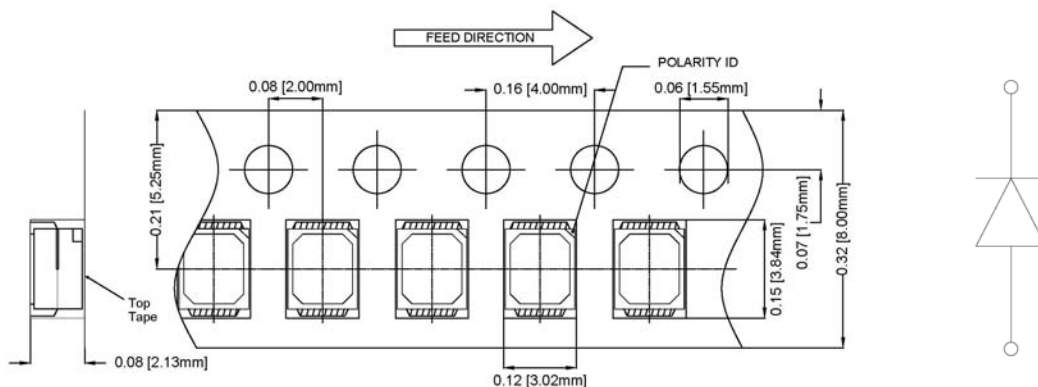

• Arrangement of Tape

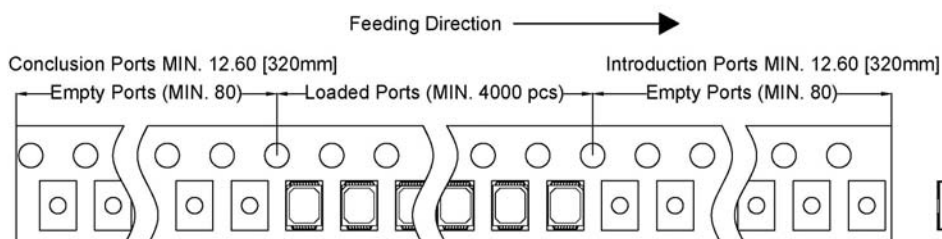

Outline Drawings Notes:

1. All dimensions are in inches [millimeters].
2. Standard tolerance: $\pm 0.010''$ unless otherwise noted.

Bivar reserves the right to make changes at any time without notice.

SURFACE MOUNT LED WHITE, 2835 PACKAGE, 0.2W

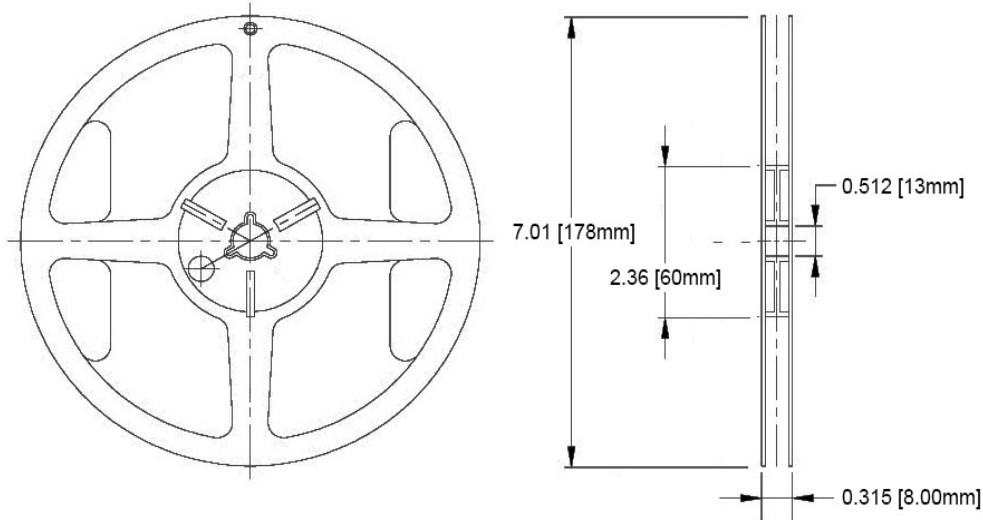

Outline Drawings Notes:

1. All dimensions are in inches [millimeters].
2. Standard tolerance unless otherwise noted: X.XXX ± 0.010"
X.X ± 0.1"

Packaging and Labeling Plan

Note: 1 Reel / Bag

Vacuum and Heat Sealed
ESD/MBB Bag

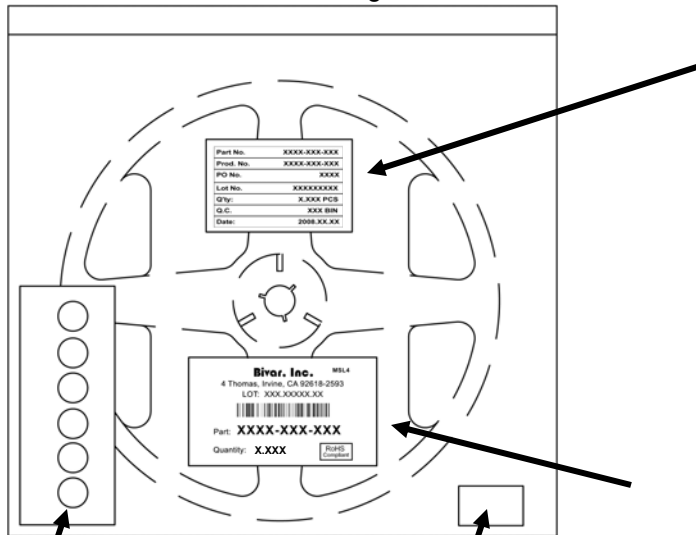

Humidity Indicator Card

Desiccants

Part No.	XXXX-XXX-XXX
Prod. No.	XXXX-XXX-XXX
PO No.	XXXX
Lot No.	XXXXXXXXXX
Q'ty:	X.XXX PCS
Q.C.	XXX BIN
Date:	2008.XX.XX

Internal Quality Control

Bivar, Inc. MSL4

4 Thomas, Irvine, CA 92618-2593
LOT: XXX.XXXXX.XX



Part: **XXXX-XXX-XXX**

Quantity: **X.XXX**

RoHS
Compliant

Bivar Standard Packaging Label

Bivar reserves the right to make changes at any time without notice.