



Chipsmall Limited consists of a professional team with an average of over 10 year of expertise in the distribution of electronic components. Based in Hongkong, we have already established firm and mutual-benefit business relationships with customers from,Europe,America and south Asia,supplying obsolete and hard-to-find components to meet their specific needs.

With the principle of “Quality Parts,Customers Priority,Honest Operation,and Considerate Service”,our business mainly focus on the distribution of electronic components. Line cards we deal with include Microchip,ALPS,ROHM,Xilinx,Pulse,ON,Everlight and Freescale. Main products comprise IC,Modules,Potentiometer,IC Socket,Relay,Connector.Our parts cover such applications as commercial,industrial, and automotives areas.

We are looking forward to setting up business relationship with you and hope to provide you with the best service and solution. Let us make a better world for our industry!



Contact us

Tel: +86-755-8981 8866 Fax: +86-755-8427 6832

Email & Skype: info@chipsmall.com Web: www.chipsmall.com

Address: A1208, Overseas Decoration Building, #122 Zhenhua RD., Futian, Shenzhen, China



●For 3-Phase Motor Drivers

Part Number	Circuit Count	V _{CE0} (V)/ V _{DSS} (V)/ V _{CEs} (V)	I _C (A)/ I _D (A)	h _{FE} (min)	R _{Ds(ON)} max (Ω)	Equivalent Circuit	Package
STA303A	3	100	4	1000		4	SIP8 (STA8Pin)
STA302A	3	-50	-4	1000		5	SIP8 (STA8Pin)
SLA5212	6	35	±8		70m	14	SIP15 with Fin (SLA15Pin)
SLA5096	6	55	±8		80m	14	SIP15 with Fin (SLA15Pin)
SLA5059	6	60	±4		0.55	6	SIP12 with Fin (SLA12Pin)
SLA5060	6	60	±6		0.22	6	SIP12 with Fin (SLA12Pin)
SLA5061	6	60	±10		0.14	6	SIP12 with Fin (SLA12Pin)
SLA5064	6	60	±10		0.14	7	SIP12 with Fin (SLA12Pin)
SMA6080	6	±60	±2	2000		9	SIP12 (SMA12Pin)
SMA6010	6	±60	±4	2000		9	SIP12 (SMA12Pin)
SLA6012	6	±60	±4	2000		8	SIP12 with Fin (SLA12Pin)
SMA5127	6	±60	±4		0.55	10	SIP12 (SMA12Pin)
SLA5022	6	±60	±6	2000	0.22	11	SIP12 with Fin (SLA12Pin)
SLA6023	6	±60	±6	2000		8	SIP12 with Fin (SLA12Pin)
SLA6024	6	±60	±8	2000		8	SIP12 with Fin (SLA12Pin)
SLA6026	6	±60	±10	2000		8	SIP12 with Fin (SLA12Pin)
SMA5125	6	±60	±10		0.14	7	SIP12 (SMA12Pin)
SLA6022	6	±80	±5	2000		8	SIP12 with Fin (SLA12Pin)
SLA6020	6	±100	±5	2000		9	SIP12 with Fin (SLA12Pin)
SMA5130	6	±250	±2.5	2000	0.9	16	SIP15 (SMA15Pin)
SMA5131	6	250	2		1.8	13	SIP12 (SMA12Pin)
SMA5112	6	250	7		0.5	13	SIP12 (SMA12Pin)
SMA5117	6	250	7		0.25	13	SIP12 (SMA12Pin)
→ SMA5132	6	500	1.5		4	13	SIP12 (SMA12Pin)
SMA5133	6	500	2.5		2	13	SIP12 (SMA12Pin)
SLA5075	6	500	±5		1.4	12	SIP15 with Fin (SLA15Pin)
SMA5118	6	500	±5		1.4	13	SIP12 (SMA12Pin)
SLA5201	6	600	7			15	SIP15 with Fin (SLA15Pin)

●For Driving Stepping Motor with Two Supplies

Part Number	Circuit Count	V _{CE0} (V)/ V _{DSS} (V)	I _C (A)/ I _D (A)	h _{FE} (min)	R _{Ds(ON)} max (Ω)	Equivalent Circuit	Package
SMA6511	5	100±15/-60	1.5/-3	2000		17	SIP12 (SMA12Pin)

●For 5-Phase Motor Drive

Part Number	Circuit Count	V _{CE0} (V)/ V _{DSS} (V)	I _C (A)/ I _D (A)	h _{FE} (min)	R _{Ds(ON)} max (Ω)	Equivalent Circuit	Package
SLA5074	4	60	5		0.3	18	SIP15 with Fin (SLA15Pin)
SLA5065	4	60	7		0.1	18	SIP15 with Fin (SLA15Pin)
SLA5073	6	60	5		0.3	14	SIP15 with Fin (SLA15Pin)
SLA5068	6	60	7		0.1	14	SIP15 with Fin (SLA15Pin)

●Equivalent Circuit (for Motor Driver)

④

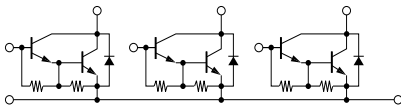

⑤

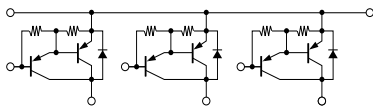

⑥

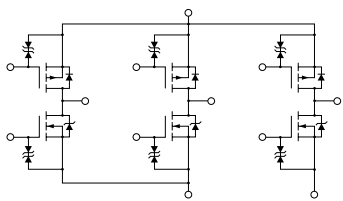

⑦

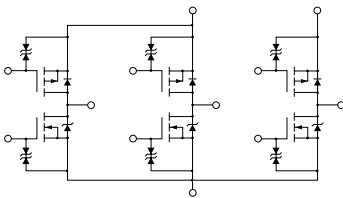

⑧

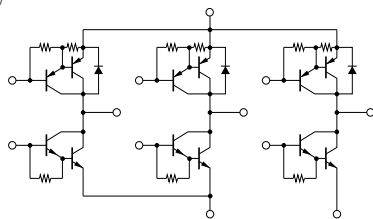

⑨

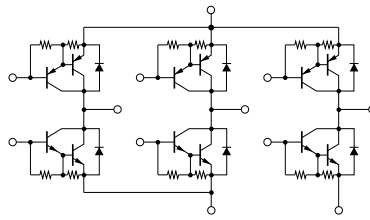

⑩

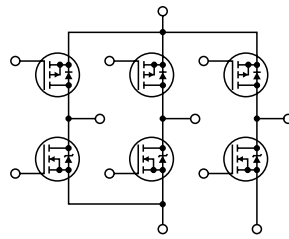

⑪

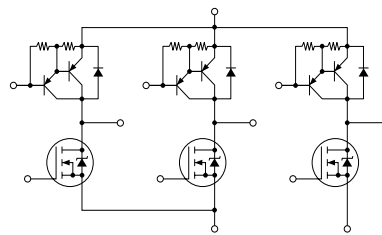

⑫

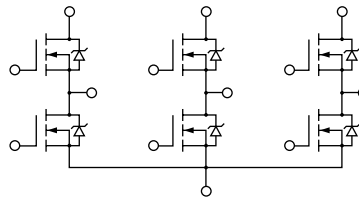

⑬

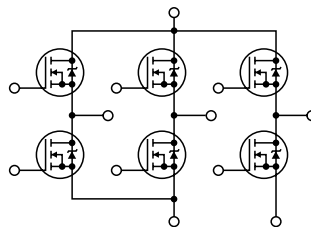

⑭

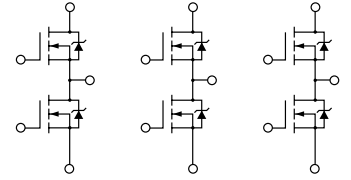

⑮

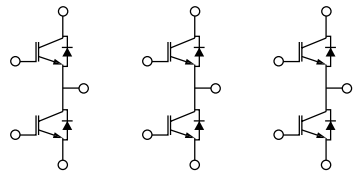

⑯

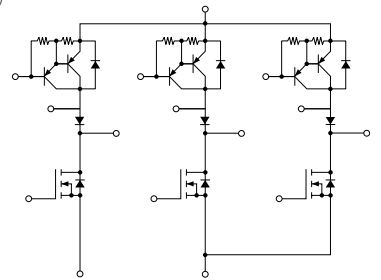

⑰

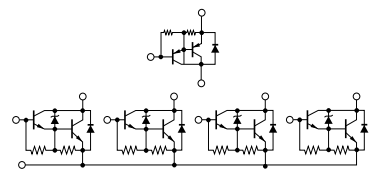

⑱

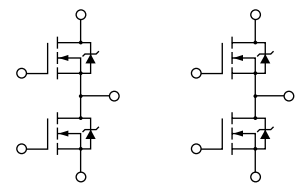

• SIP 8 (STA8Pin)

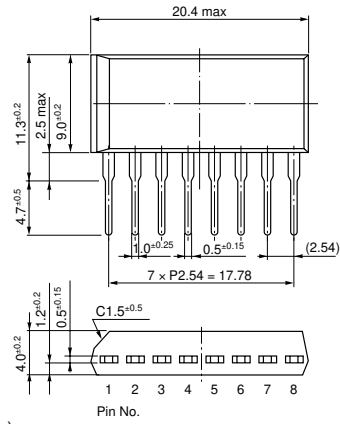

• SIP 10 (STA10Pin)

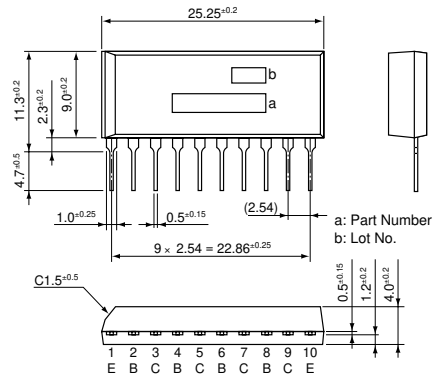

• SIP 12 (SMA12Pin)

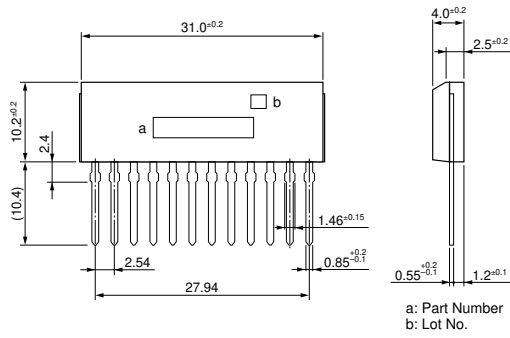

• SIP 15 (SMA15Pin)

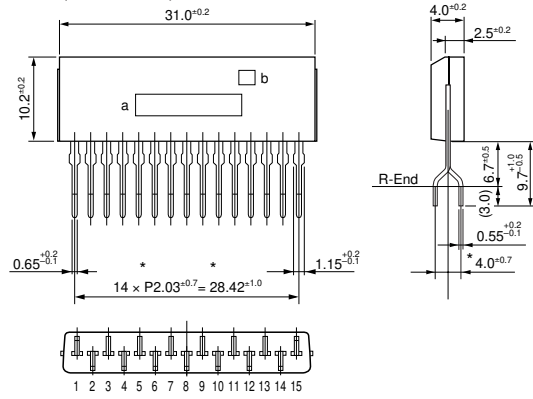

• SIP 12 with Fin (SLA12Pin)

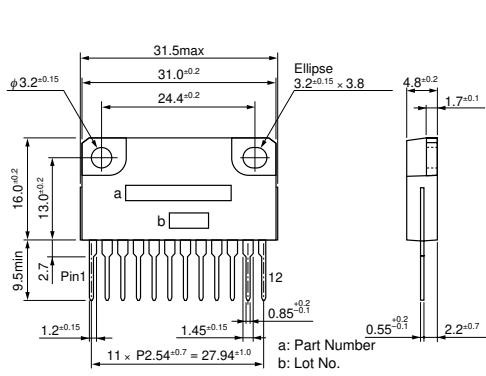

• SIP 15 with Fin (SLA15Pin)

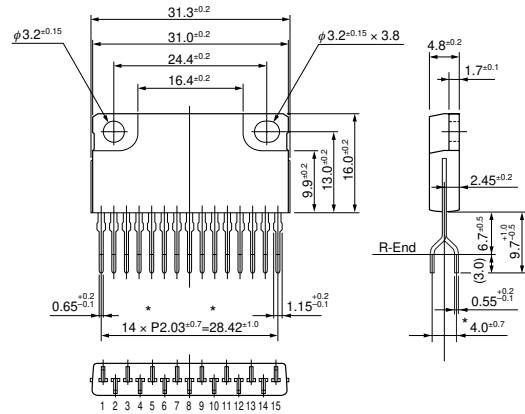

• SIP 15 with Fin (SLA15Pin)

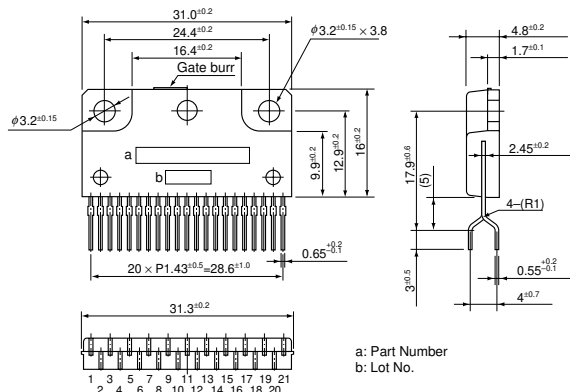

(Unit:mm)