



Chipsmall Limited consists of a professional team with an average of over 10 year of expertise in the distribution of electronic components. Based in Hongkong, we have already established firm and mutual-benefit business relationships with customers from,Europe,America and south Asia,supplying obsolete and hard-to-find components to meet their specific needs.

With the principle of "Quality Parts,Customers Priority,Honest Operation,and Considerate Service",our business mainly focus on the distribution of electronic components. Line cards we deal with include Microchip,ALPS,ROHM,Xilinx,Pulse,ON,Everlight and Freescale. Main products comprise IC,Modules,Potentiometer,IC Socket,Relay,Connector.Our parts cover such applications as commercial,industrial, and automotives areas.

We are looking forward to setting up business relationship with you and hope to provide you with the best service and solution. Let us make a better world for our industry!



Contact us

Tel: +86-755-8981 8866 Fax: +86-755-8427 6832

Email & Skype: info@chipsmall.com Web: www.chipsmall.com

Address: A1208, Overseas Decoration Building, #122 Zhenhua RD., Futian, Shenzhen, China





Features

- RoHS compliant*
- Surface Mount SMA package
- Standoff Voltage: 5.0 to 495 volts
- Power Dissipation: 400 watts

Applications

- IEC 61000-4-2 ESD (Min. Level 4)
- IEC 61000-4-4 EFT
- IEC 61000-4-5 Surge

SMAJ Transient Voltage Suppressor Diode Series

General Information

The markets of portable communications, computing and video equipment are challenging the semiconductor industry to develop increasingly smaller electronic components.

Bourns offers Transient Voltage Suppressor Diodes for surge and ESD protection applications, in compact chip package DO-214AC (SMA) size format. The Transient Voltage Suppressor series offers a choice of Working Peak Reverse Voltage from 5 V up to 495 V and Breakdown Voltage up to 550 V. Typical fast response times are less than 1.0 picoseconds for unidirectional devices and less than 5.0 picoseconds for bidirectional devices from 0 V to Minimum Breakdown Voltage.

Bourns® Chip Diodes conform to JEDEC standards, are easy to handle with standard pick and place equipment and the flat configuration minimizes roll away.

Electrical Characteristics (@ T_A = 25 °C Unless Otherwise Noted)

Parameter	Symbol	Value	Unit
Minimum Peak Pulse Power Dissipation (T _P = 1 ms) (Note 1,2)	P _{PK}	400	Watts
Peak Forward Surge Current 8.3 ms Single Half Sine Wave Superimposed on Rated Load (JEDEC Method) (Note 3)	I _{FSM}	40	Amps
Steady State Power Dissipation @ TL = 75 °C	P _{M(AV)}	1.0	Watts
Maximum Instantaneous Forward Voltage @ I _{PP} = 35 A (For Unidirectional Units Only)	V _F	3.5 5.0	Volts
Operating Temperature Range	T _J	-55 to +150	°C
Storage Temperature Range	T _{STG}	-55 to +150	°C

1. Non-repetitive current pulse, per Pulse Waveform graph and derated above T_A = 25 °C per Pulse Derating Curve.
2. Thermal Resistance Junction to Lead.
3. 8.3 ms Single Half-Sine Wave duty cycle = 4 pulses maximum per minute (unidirectional units only).

BOURNS®

Asia-Pacific:

Tel: +886-2 2562-4117
Email: asiacus@bourns.com

Europe:

Tel: +36 88 520 390
Email: eurocus@bourns.com

The Americas:

Tel: +1-951 781-5500
Email: americus@bourns.com
www.bourns.com

How to Order

SMAJ 5.0 CA - H

Package _____
SMAJ = SMA/DO-214AC

Working Peak Reverse Voltage _____
5.0 = 5.0 V_{RWM} (Volts)

Suffix _____
A = 5 % Tolerance Unidirectional Device
CA = 5 % Tolerance Bidirectional Device

Reel _____
(blank) = 13 inch reel
-H = 7 inch reel

*RoHS Directive 2002/95/EC Jan. 27, 2003 including annex and RoHS Recast 2011/65/EU June 8, 2011.

Specifications are subject to change without notice.

The device characteristics and parameters in this data sheet can and do vary in different applications and actual device performance may vary over time. Users should verify actual device performance in their specific applications.

SMAJ Transient Voltage Suppressor Diode Series

Electrical Characteristics (@ $T_A = 25\text{ }^\circ\text{C}$ Unless Otherwise Noted)

Unidirectional Device		Bidirectional Device		Breakdown Voltage V_{BR} (Volts)			Working Peak Reverse Voltage V_{RWM} (V)	Maximum Reverse Leakage @ V_{RWM} I_R (μA)	Maximum Reverse Voltage @ I_{RSM} V_{RSM} (V)	Maximum Reverse Surge Current I_{RSM} (A)
Part No.	Marking	Part No.	Marking	Min.	Max.	@ I_T (mA)				
SMAJ5.0A	HE	SMAJ5.0CA	TE	6.40	7.00	10	5.0	800	9.2	43.5
SMAJ6.0A	HG	SMAJ6.0CA	TG	6.67	7.37	10	6.0	800	10.3	38.8
SMAJ6.5A	HK	SMAJ6.5CA	TK	7.22	7.98	10	6.5	500	11.2	35.7
SMAJ7.0A	HM	SMAJ7.0CA	TM	7.78	8.60	10	7.0	200	12.0	33.3
SMAJ7.5A	HP	SMAJ7.5CA	TP	8.33	9.21	1.0	7.5	100	12.9	31.0
SMAJ8.0A	HR	SMAJ8.0CA	TR	8.89	9.83	1.0	8.0	50	13.6	29.4
SMAJ8.5A	HT	SMAJ8.5CA	TT	9.44	10.4	1.0	8.5	20	14.4	27.8
SMAJ9.0A	HV	SMAJ9.0CA	TV	10.0	11.1	1.0	9.0	10	15.4	26.0
SMAJ10A	HX	SMAJ10CA	TX	11.1	12.3	1.0	10	5	17.0	23.5
SMAJ11A	HZ	SMAJ11CA	TZ	12.2	13.5	1.0	11	1.0	18.2	22.0
SMAJ12A	IE	SMAJ12CA	UE	13.3	14.7	1.0	12	1.0	19.9	20.1
SMAJ13A	IG	SMAJ13CA	UG	14.4	15.9	1.0	13	1.0	21.5	18.6
SMAJ14A	IK	SMAJ14CA	UK	15.6	17.2	1.0	14	1.0	23.2	17.2
SMAJ15A	IM	SMAJ15CA	UM	16.7	18.5	1.0	15	1.0	24.4	16.4
SMAJ16A	IP	SMAJ16CA	UP	17.8	19.7	1.0	16	1.0	26.0	15.3
SMAJ17A	IR	SMAJ17CA	UR	18.9	20.9	1.0	17	1.0	27.6	14.5
SMAJ18A	IT	SMAJ18CA	UT	20.0	22.1	1.0	18	1.0	29.2	13.7
SMAJ20A	IV	SMAJ20CA	UV	22.2	24.5	1.0	20	1.0	32.4	12.3
SMAJ22A	IX	SMAJ22CA	UX	24.4	26.9	1.0	22	1.0	35.5	11.3
SMAJ24A	IZ	SMAJ24CA	UZ	26.7	29.5	1.0	24	1.0	38.9	10.3
SMAJ26A	JE	SMAJ26CA	VE	28.9	31.9	1.0	26	1.0	42.1	9.5
SMAJ28A	JG	SMAJ28CA	VG	31.1	34.4	1.0	28	1.0	45.4	8.8
SMAJ30A	JK	SMAJ30CA	VK	33.3	36.8	1.0	30	1.0	48.4	8.3
SMAJ33A	JM	SMAJ33CA	VM	36.7	40.6	1.0	33	1.0	53.3	7.5
SMAJ36A	JP	SMAJ36CA	VP	40	44.2	1.0	36	1.0	58.1	6.9
SMAJ40A	JR	SMAJ40CA	VR	44.4	49.1	1.0	40	1.0	64.5	6.2
SMAJ43A	JT	SMAJ43CA	VT	47.8	52.8	1.0	43	1.0	69.4	5.8
SMAJ45A	JV	SMAJ45CA	VV	50	55.3	1.0	45	1.0	72.7	5.5
SMAJ48A	JX	SMAJ48CA	VX	53.3	58.9	1.0	48	1.0	77.4	5.2
SMAJ51A	JZ	SMAJ51CA	VZ	56.7	62.7	1.0	51	1.0	82.4	4.9
SMAJ54A	RE	SMAJ54CA	WE	60	66.3	1.0	54	1.0	87.1	4.6
SMAJ58A	RG	SMAJ58CA	WG	64.4	71.2	1.0	58	1.0	93.6	4.3
SMAJ60A	RK	SMAJ60CA	WK	66.7	73.7	1.0	60	1.0	96.8	4.1
SMAJ64A	RM	SMAJ64CA	WM	71.1	78.6	1.0	64	1.0	103	3.9
SMAJ70A	RP	SMAJ70CA	WP	77.8	86.0	1.0	70	1.0	113	3.5
SMAJ75A	RR	SMAJ75CA	WR	83.3	92.1	1.0	75	1.0	121	3.3
SMAJ78A	RT	SMAJ78CA	WT	86.7	95.8	1.0	78	1.0	126	3.2
SMAJ85A	RV	SMAJ85CA	VV	94.4	104	1.0	85	1.0	137	2.9
SMAJ90A	RX	SMAJ90CA	WX	100	111	1.0	90	1.0	146	2.7
SMAJ100A	RZ	SMAJ100CA	WZ	111	123	1.0	100	1.0	162	2.5
SMAJ110A	SE	SMAJ110CA	XE	122	135	1.0	110	1.0	177	2.3
SMAJ120A	SG	SMAJ120CA	XG	133	147	1.0	120	1.0	193	2.1
SMAJ130A	SK	SMAJ130CA	XK	144	159	1.0	130	1.0	209	1.9
SMAJ150A	SM	SMAJ150CA	XM	167	185	1.0	150	1.0	243	1.6
SMAJ160A	SP	SMAJ160CA	XP	178	197	1.0	160	1.0	259	1.5
SMAJ170A	SR	SMAJ170CA	XR	189	209	1.0	170	1.0	275	1.5
SMAJ180A	ST	SMAJ180CA	XT	201	222	1.0	180	1.0	292	1.4
SMAJ200A	SV	SMAJ200CA	XV	224	247	1.0	200	1.0	324	1.2
SMAJ220A	SX	SMAJ220CA	XX	246	272	1.0	220	1.0	356	1.1
SMAJ250A	SZ	SMAJ250CA	XZ	279	309	1.0	250	1.0	405	1.0
SMAJ300A	FE	SMAJ300CA	GE	335	371	1.0	300	1.0	486	0.8
SMAJ350A	FG	SMAJ350CA	GG	391	432	1.0	350	1.0	567	0.7
SMAJ400A	FK	SMAJ400CA	GK	447	494	1.0	400	1.0	648	0.6
SMAJ434A	434U	SMAJ434CA	434D	485	535	1.0	434	1.0	698	0.6
SMAJ440A	FM	SMAJ440CA	GM	492	543	1.0	440	1.0	713	0.6
SMAJ495A	495U	SMAJ495CA	495D	522	578	1.0	495	1.0	760	0.5

Notes: 1. Suffix 'A' denotes a 5 % tolerance unidirectional device. 3. For bidirectional devices with a V_R of 10 volts or less, the I_R limit is double.
 2. Suffix 'CA' denotes a 5 % tolerance bidirectional device.

Specifications are subject to change without notice.

The device characteristics and parameters in this data sheet can and do vary in different applications and actual device performance may vary over time. Users should verify actual device performance in their specific applications.

SMAJ Transient Voltage Suppressor Diode Series

BOURNS®

Product Dimensions

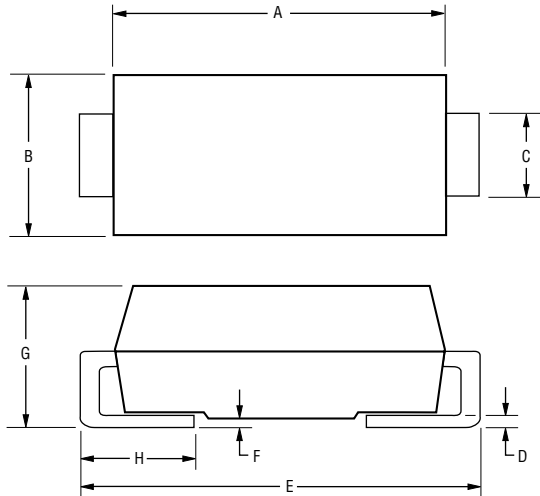

Dimension	SMA (DO-214AC)
A	$\frac{3.99 - 4.57}{(0.157 - 0.180)}$
B	$\frac{2.29 - 2.92}{(0.090 - 0.115)}$
C	$\frac{1.25 - 1.65}{(0.049 - 0.065)}$
D	$\frac{0.15 - 0.31}{(0.006 - 0.112)}$
E	$\frac{4.83 - 5.59}{(0.190 - 0.220)}$
F	$\frac{0.05 - 0.203}{(0.002 - 0.008)}$
G	$\frac{1.98 - 2.62}{(0.078 - 0.103)}$
H	$\frac{0.76 - 1.52}{(0.030 - 0.060)}$

DIMENSIONS: $\frac{\text{MM}}{\text{(INCHES)}}$

Recommended Footprint

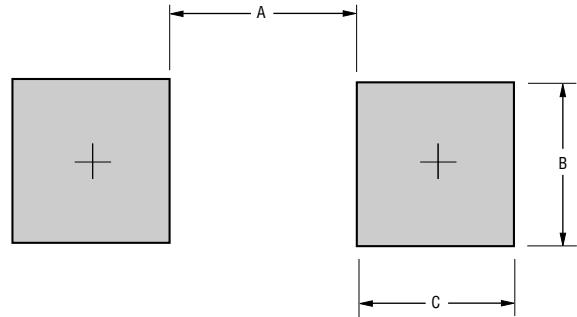

Dimension	SMA (DO-214AC)
A (Max.)	$\frac{2.70}{(0.106)}$
B (Min.)	$\frac{2.10}{(0.083)}$
C (Min.)	$\frac{1.27}{(0.050)}$

DIMENSIONS: $\frac{\text{MM}}{\text{(INCHES)}}$

Physical Specifications

CaseMolded plastic per UL Class 94V-0
 Polarity..... Cathode band indicates unidirectional device
 No cathode band indicates bidirectional device
 Weight0.064 grams

SMAJ Transient Voltage Suppressor Diode Series



Rating & Characteristic Curves

Pulse Derating Curve

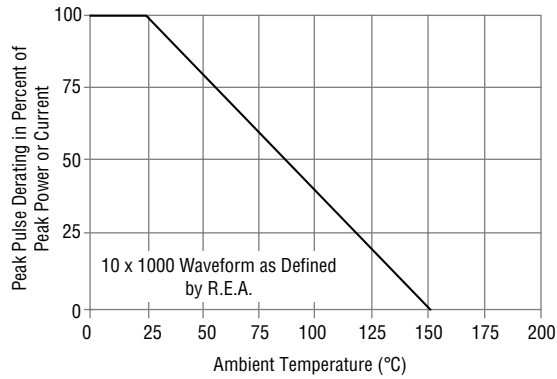

Maximum Non-Repetitive Surge Current

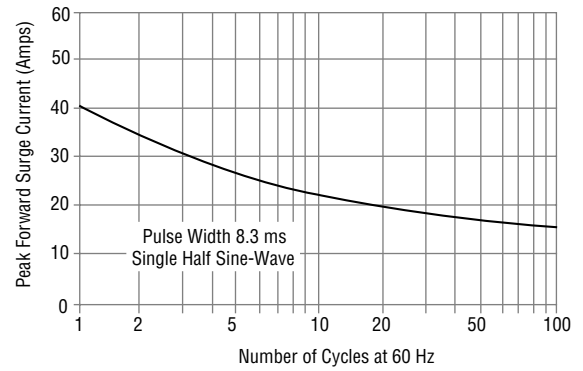

Pulse Waveform

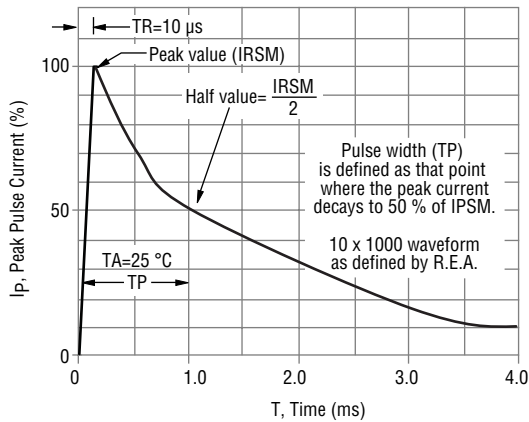

Typical Junction Capacitance

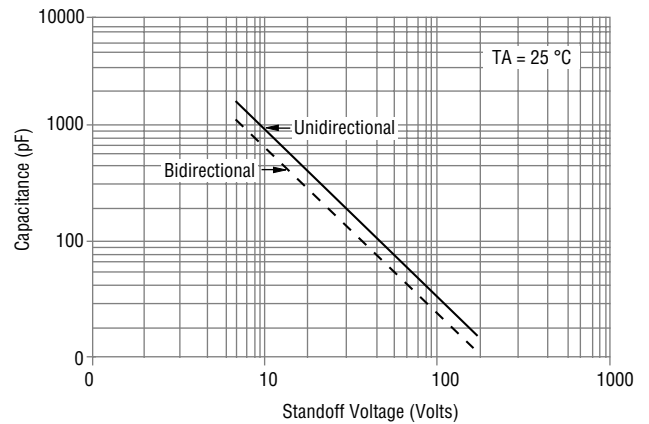

Pulse Rating Curve

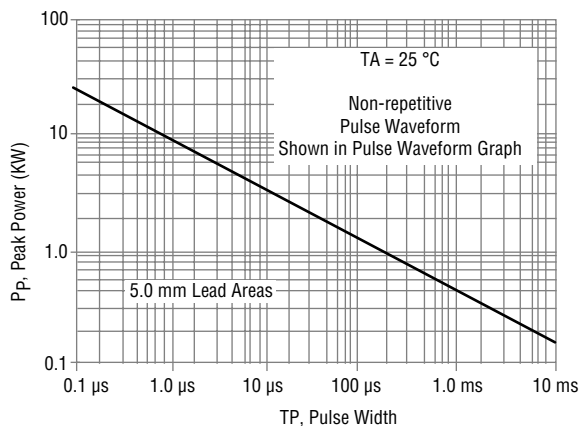

Steady State Power Derating Curve

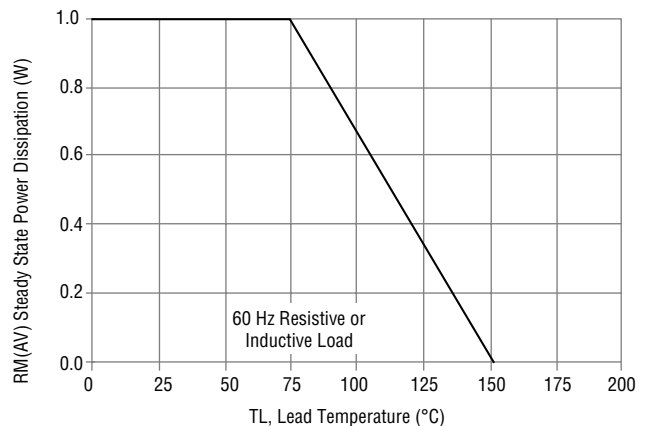

Specifications are subject to change without notice. The device characteristics and parameters in this data sheet can and do vary in different applications and actual device performance may vary over time. Users should verify actual device performance in their specific applications.

SMAJ Transient Voltage Suppressor Diode Series

BOURNS®

Packaging Information

The product will be dispensed in tape and reel format (see diagram below).

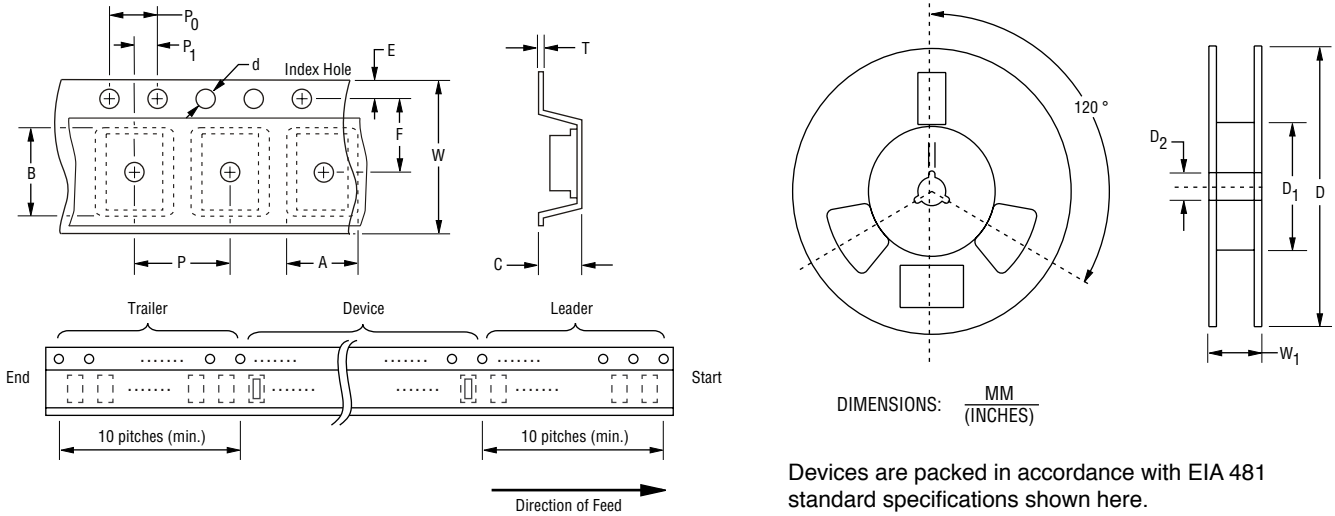

Devices are packed in accordance with EIA 481 standard specifications shown here.

Item	Symbol	SMA (DO-214AC)	
		7 Inch Reel	13 Inch Reel
Carrier Width	A	2.90 ± 0.20 (0.114 ± 0.008)	
Carrier Length	B	5.50 ± 0.20 (0.217 ± 0.008)	
Carrier Depth	C	2.26 ± 0.20 (0.089 ± 0.008)	
Sprocket Hole	d	1.50 ± 0.10 (0.061 ± 0.004)	
Reel Outside Diameter	D	$\frac{178}{(7.008)}$	$\frac{330}{(12.992)}$
Reel Inner Diameter	D ₁	$\frac{50.0}{(1.969)}$ MIN.	
Feed Hole Diameter	D ₂	13.0 ± 0.20 (0.512 ± 0.008)	
Sprocket Hole Position	E	1.75 ± 0.10 (0.069 ± 0.004)	
Punch Hole Position	F	5.50 ± 0.05 (0.217 ± 0.002)	
Punch Hole Pitch	P	4.00 ± 0.10 (0.157 ± 0.004)	
Sprocket Hole Pitch	P ₀	4.00 ± 0.10 (0.157 ± 0.004)	
Embossment Center	P ₁	2.00 ± 0.05 (0.079 ± 0.002)	
Overall Tape Thickness	T	0.30 ± 0.10 (0.012 ± 0.004)	
Tape Width	W	12.00 ± 0.30 (0.472 ± 0.012)	
Reel Width	W ₁	$\frac{18.4}{(0.724)}$ MAX.	
Quantity per Reel	--	1,000	5,000

REV. 06/16

Specifications are subject to change without notice.
The device characteristics and parameters in this data sheet can and do vary in different applications and actual device performance may vary over time.
Users should verify actual device performance in their specific applications.