



Chipsmall Limited consists of a professional team with an average of over 10 year of expertise in the distribution of electronic components. Based in Hongkong, we have already established firm and mutual-benefit business relationships with customers from,Europe,America and south Asia,supplying obsolete and hard-to-find components to meet their specific needs.

With the principle of "Quality Parts,Customers Priority,Honest Operation,and Considerate Service",our business mainly focus on the distribution of electronic components. Line cards we deal with include Microchip,ALPS,ROHM,Xilinx,Pulse,ON,Everlight and Freescale. Main products comprise IC,Modules,Potentiometer,IC Socket,Relay,Connector.Our parts cover such applications as commercial,industrial, and automotives areas.

We are looking forward to setting up business relationship with you and hope to provide you with the best service and solution. Let us make a better world for our industry!



Contact us

Tel: +86-755-8981 8866 Fax: +86-755-8427 6832

Email & Skype: info@chipsmall.com Web: www.chipsmall.com

Address: A1208, Overseas Decoration Building, #122 Zhenhua RD., Futian, Shenzhen, China





Features

- Surface Mount SMB package
- Standoff Voltage: 12 to 58 volts
- Power Dissipation: 600 watts
- RoHS compliant*
- AEC-Q101 compliant**

Applications

- Protection of power buses
- Protection of I/O interfaces
- Overvoltage transient protection
- Automotive
 - Entertainment applications
 - Comfort applications
- Telecom, computer, industrial and consumer electronics applications

SMBJ-Q Transient Voltage Suppressor Diode Series

General Information

Bourns offers Transient Voltage Suppressor Diodes for surge and ESD protection applications, in compact chip package DO-214AA (SMB) size format. The Transient Voltage Suppressor series offers a choice of Working Peak Reverse Voltage from 12 V up to 58 V. Typical fast response times are less than 1.0 picosecond from 0 V to Breakdown Voltage.

Bourns® Chip Diodes conform to JEDEC standards, are easy to handle with standard pick and place equipment and the flat configuration minimizes roll away.

Electrical Characteristics (@ T_A = 25 °C Unless Otherwise Noted)

Parameter	Symbol	Value	Unit
Minimum Peak Pulse Power Dissipation (T _P = 1 ms) (Note 1,2)	P _{PK}	600	Watts
Peak Forward Surge Current 8.3 ms Single Half Sine Wave Superimposed on Rated Load (JEDEC Method) (Note 3)	I _{FSM}	100	Amps
Operating Temperature Range	T _J	-55 to +150	°C
Storage Temperature Range	T _{STG}	-55 to +150	°C

1. Non-repetitive current pulse, per Pulse Waveform graph and derated above T_A = 25 °C per Pulse Derating Curve.
2. Mounted on 5.0 mm² (0.03 mm thick) copper pads to each terminal.
3. 8.3 ms Single Half-Sine Wave duty cycle = 4 pulses maximum per minute (unidirectional units only).

BOURNS®

Asia-Pacific: Tel: +886-2 2562-4117 • Email: asiacus@bourns.com

EMEA: Tel: +36 88 520 390 • Email: eurocus@bourns.com

The Americas: Tel: +1-951 781-5500 • Email: americus@bourns.com

www.bourns.com

*RoHS Directive 2002/95/EC Jan. 27, 2003 including annex and RoHS Recast 2011/65/EU June 8, 2011.

**"Q" part number suffix indicates AEC-Q101 compliance.

Specifications are subject to change without notice.

The device characteristics and parameters in this data sheet can and do vary in different applications and actual device performance may vary over time. Users should verify actual device performance in their specific applications.

SMBJ-Q Transient Voltage Suppressor Diode Series

BOURNS®

Electrical Characteristics (@ T_A = 25 °C Unless Otherwise Noted)

Unidirectional Device		Bidirectional Device		Breakdown Voltage V _{BR} (Volts)			Working Peak Reverse Voltage	Maximum Reverse Leakage @ V _{RWM}	Maximum Reverse Voltage @ I _{RSM}	Maximum Reverse Surge Current
Part No.	Marking	Part No.	Marking	Min.	Max.	@ I _T (mA)	V _{RWM} (V)	I _R (μA)	V _{RSM} (V)	I _{RSM} (A)
SMBJ12A-Q	LEQ	SMBJ12CA-Q	BEQ	13.3	14.7	1.0	12	1.0	19.9	30.2
SMBJ13A-Q	LGQ	SMBJ13CA-Q	BGQ	14.4	15.9	1.0	13	1.0	21.5	28.0
SMBJ14A-Q	LKQ	SMBJ14CA-Q	BKQ	15.6	17.2	1.0	14	1.0	23.2	25.9
SMBJ15A-Q	LMQ	SMBJ15CA-Q	BMQ	16.7	18.5	1.0	15	1.0	24.4	24.6
SMBJ16A-Q	LPQ	SMBJ16CA-Q	BPQ	17.8	19.7	1.0	16	1.0	26.0	23.1
SMBJ17A-Q	LRQ	SMBJ17CA-Q	BRQ	18.9	20.9	1.0	17	1.0	27.6	21.8
SMBJ18A-Q	LTQ	SMBJ18CA-Q	BTQ	20.0	22.1	1.0	18	1.0	29.2	20.6
SMBJ20A-Q	LVQ	SMBJ20CA-Q	BVQ	22.2	24.5	1.0	20	1.0	32.4	18.6
SMBJ22A-Q	LXQ	SMBJ22CA-Q	BXQ	24.4	26.9	1.0	22	1.0	35.5	16.9
SMBJ24A-Q	LZQ	SMBJ24CA-Q	BZQ	26.7	29.5	1.0	24	1.0	38.9	15.5
SMBJ26A-Q	MEQ	SMBJ26CA-Q	CEQ	28.9	31.9	1.0	26	1.0	42.1	14.3
SMBJ28A-Q	MGQ	SMBJ28CA-Q	CGQ	31.1	34.4	1.0	28	1.0	45.4	13.3
SMBJ30A-Q	MKQ	SMBJ30CA-Q	CKQ	33.3	36.8	1.0	30	1.0	48.4	12.4
SMBJ33A-Q	MMQ	SMBJ33CA-Q	CMQ	36.7	40.6	1.0	33	1.0	53.3	11.3
SMBJ36A-Q	MPQ	SMBJ36CA-Q	CPQ	40.0	44.2	1.0	36	1.0	58.1	10.4
SMBJ40A-Q	MRQ	SMBJ40CA-Q	CRQ	44.4	49.1	1.0	40	1.0	64.5	9.3
SMBJ43A-Q	MTQ	SMBJ43CA-Q	CTQ	47.8	52.8	1.0	43	1.0	69.4	8.7
SMBJ45A-Q	MVQ	SMBJ45CA-Q	CVQ	50.0	55.3	1.0	45	1.0	72.7	8.3
SMBJ48A-Q	MXQ	SMBJ48CA-Q	CXQ	53.3	58.9	1.0	48	1.0	77.4	7.8
SMBJ51A-Q	MZQ	SMBJ51CA-Q	CZQ	56.7	62.7	1.0	51	1.0	82.4	7.3
SMBJ54A-Q	NEQ	SMBJ54CA-Q	DEQ	60.0	66.3	1.0	54	1.0	87.1	6.9
SMBJ58A-Q	NGQ	SMBJ58CA-Q	DGQ	64.4	71.2	1.0	58	1.0	93.6	6.5

- Notes: 1. Suffix 'A' denotes a 5 % tolerance unidirectional device.
 2. Suffix 'CA' denotes a 5 % tolerance bidirectional device.

Specifications are subject to change without notice.

The device characteristics and parameters in this data sheet can and do vary in different applications and actual device performance may vary over time. Users should verify actual device performance in their specific applications.

SMBJ-Q Transient Voltage Suppressor Diode Series

BOURNS®

Performance Graphs

Peak Pulse Power Derating Curve

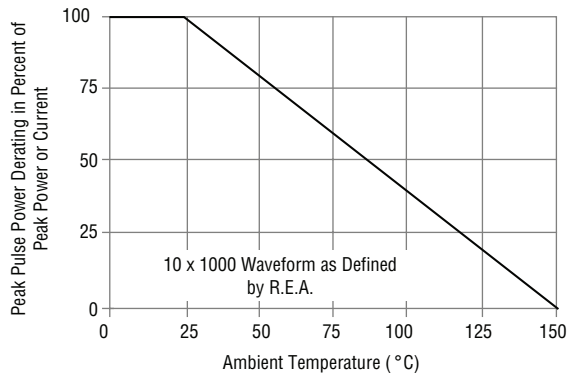

Maximum Non-Repetitive Surge Current

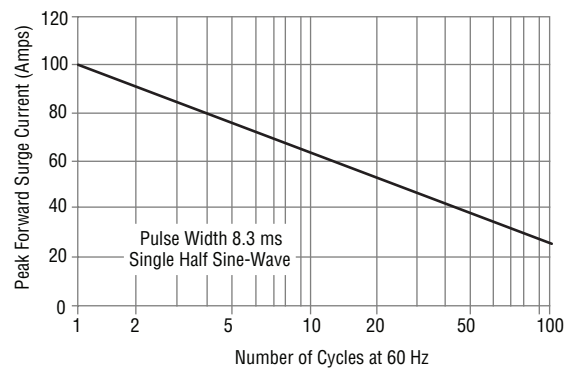

Pulse Waveform

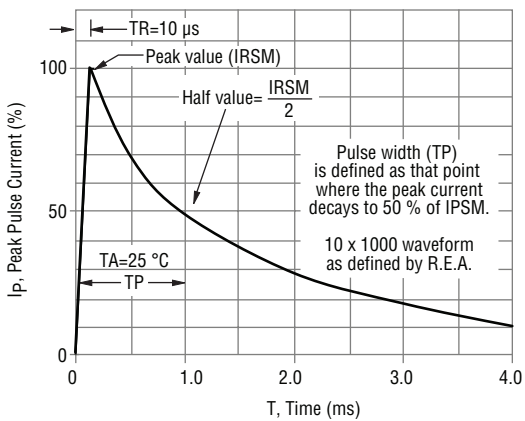

Typical Junction Capacitance

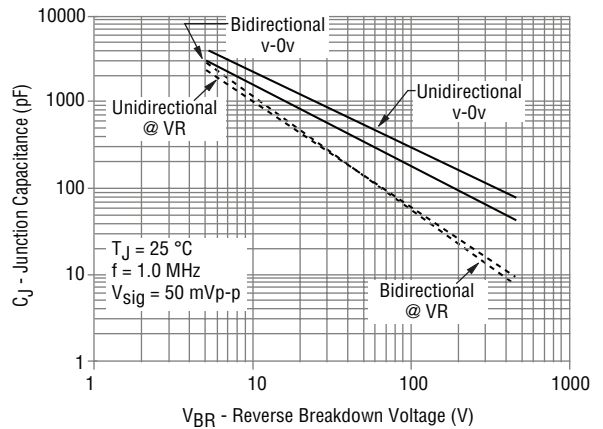

Pulse Rating Curve

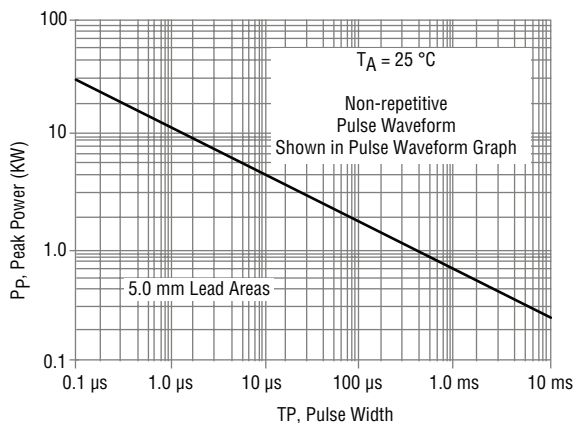

Steady State Power Derating Curve

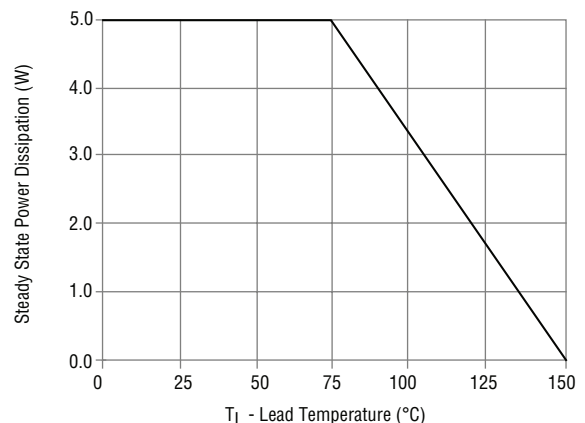

Specifications are subject to change without notice. The device characteristics and parameters in this data sheet can and do vary in different applications and actual device performance may vary over time. Users should verify actual device performance in their specific applications.

SMBJ-Q Transient Voltage Suppressor Diode Series



Product Dimensions

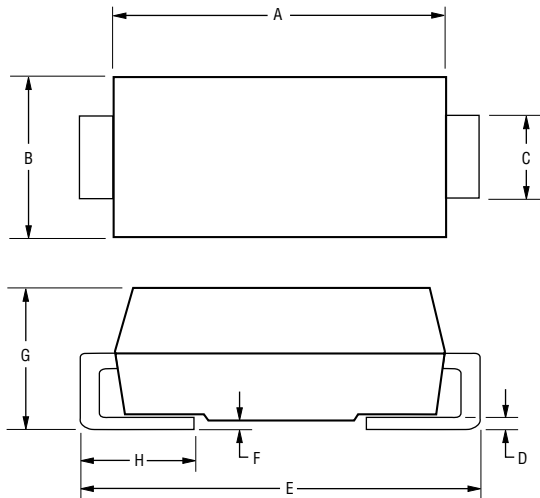

Dimension	SMB (DO-214AA)
A	$\frac{4.06 - 4.57}{(0.160 - 0.180)}$
B	$\frac{3.30 - 3.94}{(0.130 - 0.155)}$
C	$\frac{1.95 - 2.20}{(0.077 - 0.087)}$
D	$\frac{0.15 - 0.31}{(0.006 - 0.112)}$
E	$\frac{5.21 - 5.59}{(0.205 - 0.220)}$
F	$\frac{0.203}{(0.008)}$ MAX.
G	$\frac{2.13 - 2.44}{(0.080 - 0.103)}$
H	$\frac{0.76 - 1.52}{(0.030 - 0.060)}$

DIMENSIONS: $\frac{\text{MM}}{\text{(INCHES)}}$

Typical Part Marking

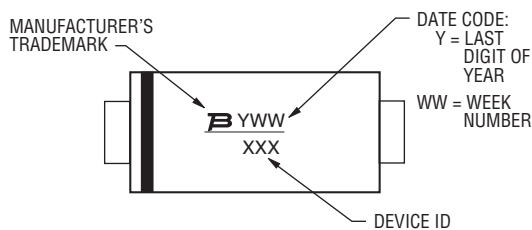

Recommended Footprint

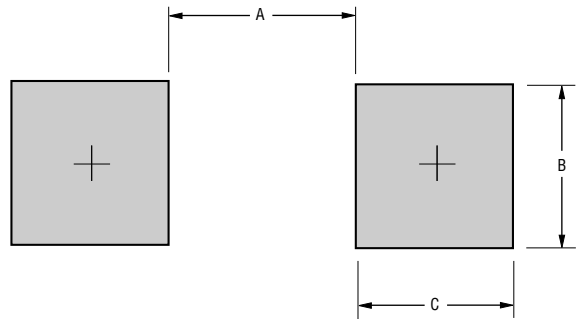

Dimension	SMB (DO-214AA)
A (Max.)	$\frac{2.69}{(0.106)}$
B (Min.)	$\frac{2.10}{(0.083)}$
C (Min.)	$\frac{1.27}{(0.050)}$

DIMENSIONS: $\frac{\text{MM}}{\text{(INCHES)}}$

Physical Specifications

Case Molded plastic per UL Class 94V-0
 Polarity..... Cathode band indicates unidirectional device
 No cathode band indicates bidirectional device

How to Order

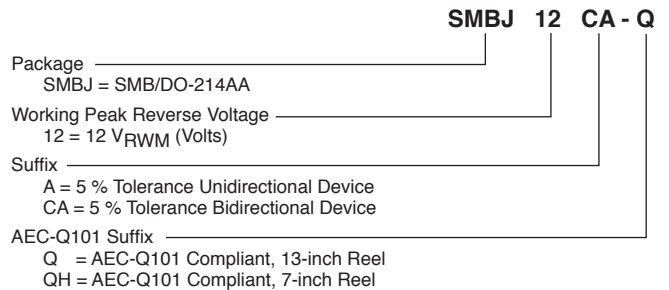

Environmental Specifications

Moisture Sensitivity Level 1
 ESD Classification (HBM) 3B

Specifications are subject to change without notice.
 The device characteristics and parameters in this data sheet can and do vary in different applications and actual device performance may vary over time.
 Users should verify actual device performance in their specific applications.

SMBJ-Q Transient Voltage Suppressor Diode Series

BOURNS®

Packaging Information

The product will be dispensed in tape and reel format (see diagram below).

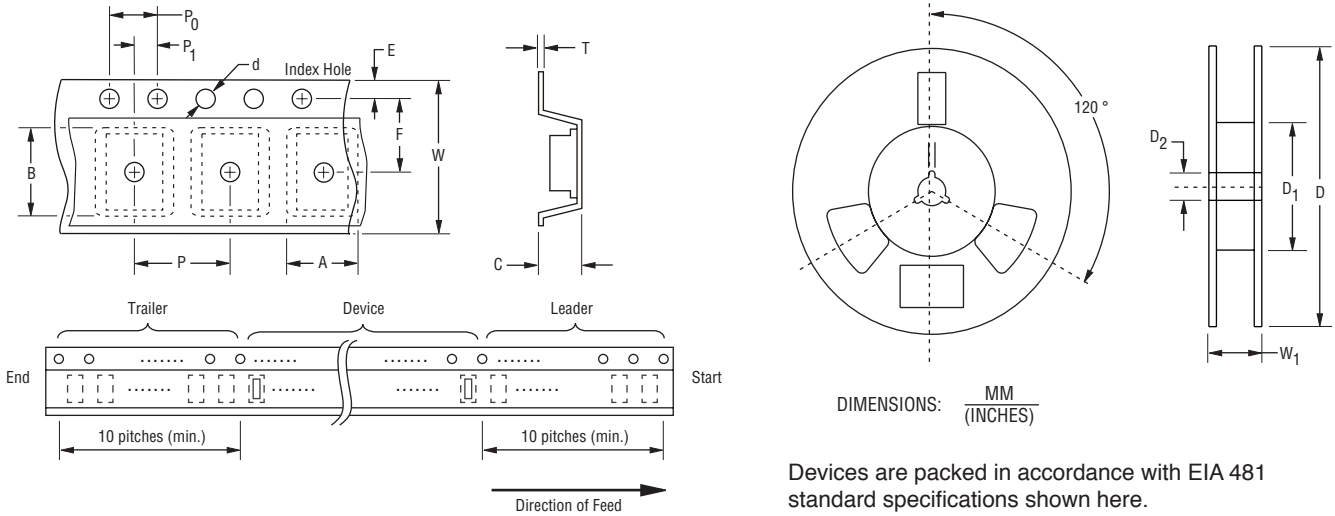

Item	Symbol	SMB (DO-214AA)	
		7-Inch Reel	13-Inch Reel
Carrier Width	A	$\frac{3.67 \pm 0.20}{(0.144 \pm 0.008)}$	
Carrier Length	B	$\frac{5.60 \pm 0.20}{(0.220 \pm 0.008)}$	
Carrier Depth	C	$\frac{2.57 \pm 0.20}{(0.101 \pm 0.008)}$	
Sprocket Hole	d	$\frac{1.50 \pm 0.10}{(0.059 \pm 0.004)}$	
Reel Outside Diameter	D	$\frac{178}{(7.008)}$	$\frac{330}{(12.992)}$
Reel Inner Diameter	D ₁	$\frac{50.0}{(1.969)}$ MIN.	
Feed Hole Diameter	D ₂	$\frac{13.0 \pm 0.20}{(0.512 \pm 0.008)}$	
Sprocket Hole Position	E	$\frac{1.75 \pm 0.10}{(0.069 \pm 0.004)}$	
Punch Hole Position	F	$\frac{5.50 \pm 0.05}{(0.217 \pm 0.002)}$	
Punch Hole Pitch	P	$\frac{8.00 \pm 0.10}{(0.315 \pm 0.004)}$	
Sprocket Hole Pitch	P ₀	$\frac{4.00 \pm 0.10}{(0.157 \pm 0.004)}$	
Embossment Center	P ₁	$\frac{2.00 \pm 0.05}{(0.079 \pm 0.002)}$	
Overall Tape Thickness	T	$\frac{0.30 \pm 0.10}{(0.012 \pm 0.004)}$	
Tape Width	W	$\frac{12.00 \pm 0.30}{(0.472 \pm 0.012)}$	
Reel Width	W ₁	$\frac{18.4}{(0.724)}$ MAX.	
Quantity per Reel	--	500	3,000

REV. 02/18

Specifications are subject to change without notice. The device characteristics and parameters in this data sheet can and do vary in different applications and actual device performance may vary over time. Users should verify actual device performance in their specific applications.