



Chipsmall Limited consists of a professional team with an average of over 10 year of expertise in the distribution of electronic components. Based in Hongkong, we have already established firm and mutual-benefit business relationships with customers from,Europe,America and south Asia,supplying obsolete and hard-to-find components to meet their specific needs.

With the principle of “Quality Parts,Customers Priority,Honest Operation,and Considerate Service”,our business mainly focus on the distribution of electronic components. Line cards we deal with include Microchip,ALPS,ROHM,Xilinx,Pulse,ON,Everlight and Freescale. Main products comprise IC,Modules,Potentiometer,IC Socket,Relay,Connector.Our parts cover such applications as commercial,industrial, and automotives areas.

We are looking forward to setting up business relationship with you and hope to provide you with the best service and solution. Let us make a better world for our industry!



Contact us

Tel: +86-755-8981 8866 Fax: +86-755-8427 6832

Email & Skype: info@chipsmall.com Web: www.chipsmall.com

Address: A1208, Overseas Decoration Building, #122 Zhenhua RD., Futian, Shenzhen, China



Integrated AC LED Solution

Acrich2 – 13W

SMJE-XV12W1P3

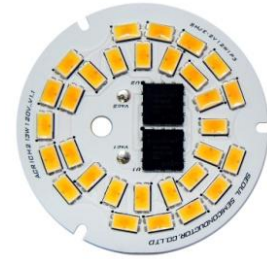

Product Brief

Description

- The Acrich2 series of products are designed to be driven directly off of AC line voltage, therefore they do not need the standard converter essential for conventional general lighting products.
- The converter or driver found in most general lighting products can limit the overall life of the product, but with the Acrich2 series of products the life of the product can more closely be estimated from the LED itself. This will also allow for a much smaller form factor from an overall fixture design allowing for higher creativity in the fixture.
- The modules have a high power factor which can contribute to a higher energy savings in the end application.

Features and Benefits

- Connects directly to AC line voltage
- High Power Efficiency & Factor
- Low THD
- Long Life Time
- Simple BOM
- Miniaturization
- Lead Free Product
- RoHS Compliant

Key Applications

- Bulb light
- Down light
- Factory Ceiling light
- Industrial Light

Table 1. Product Selection (CCT)

Part No.	Vin [Vac]	P [W]	Color	CCT [K]	CRI
					Min.
SMJE-2V12W1P3	120	13	Cool	4700 – 6000	80
SMJE-3V12W1P3	220		Neutral	3700 – 4200	
			Warm	2600 – 3200	

Table 2. Product Selection (Flux)

Part No.	Vin [Vac]	P [W]	Flux Bin	Flux [lm]	
				Min.	Typ.
SMJE-2V12W1P3	120	13	13a	880	1000
SMJE-3V12W1P3	220		13b	1140	1210

Table of Contents

Index	
• Product Brief	
• Table of Contents	
• Performance Characteristics	
• Absolute Maximum Ratings	
• Thermal Resistance	
• Relative Spectral Distribution	
• Relative Power Distribution	
• Relative Luminous Distribution	
• Luminous Flux Characteristics	
• Color Bin Structure	
• Part List	
• Mechanical Dimensions	
• Circuit Drawing	
• Marking Information	
• Packing & Label Information	
• Handling of Silicone Resin for LEDs	
• Precaution for Use	
• Company Information	

Performance Characteristics

Table 3. Electro Optical Characteristics, T_a = 25°C

Parameter	Symbol	Value			Unit	Mark
		Min.	Typ.	Max.		
Luminous Flux	Φ_v ^[2]	880	1000	1140	lm	13a
		1140	1210	1300		13b
Correlated Color Temperature ^[3]	CCT	5300	5600	6000	K	B
		4700	5000	5300		C
		3700	4000	4200		E
		2900	3000	3200		G
		2600	2700	2900		H
CRI	Ra	80	-	-	-	
Input Voltage ^[4]	V _{in}	120			Vac	2V
		220				3V
Power Consumption	P	12.5	13.0	13.5	W	13W
Operating Frequency	f	50 / 60			Hz	
Power Factor	PF	Over 0.95			-	
Viewing Angle	2 $\Theta_{1/2}$	120			deg.	

Notes :

- (1) At 120Vac/220Vac, T_a = 25°C
- (2) Φ_v is the total luminous flux output measured with an integrated sphere.
- (3) Correlated Color Temperature is derived from the CIE 1931 Chromaticity diagram.
- (4) Operating Voltage doesn't indicate the maximum voltage which customers use but means tolerable voltage according to each country's voltage variation rate. It is recommended that the solder pad temperature should be below 70 °C.

Absolute Maximum Ratings

Table 4. Absolute Maximum Ratings, $T_a = 25^\circ\text{C}$

Parameter	Symbol	Unit	Value
Maximum Input Voltage @120Vac	V_{in}	Vac	140
Maximum Input Voltage @220Vac			264
Power Consumption	P	W	17.5
Operating Temperature	T_{opr}	$^\circ\text{C}$	-30 ~ 85
Storage Temperature	T_{stg}	$^\circ\text{C}$	-40 ~ 100
ESD Sensitivity	-	-	$\pm 4,000\text{V HBM}$

Thermal Resistance

Part	Package Power Dissipation [W]	Maximum Junction Temperature [°C]	R θ_{j-s} [°C/W]
Acrich2 LED	SAW8KG0B Max 0.58	125	27

The Acrich2 LED has a thermal resistance of 27 °C/W from junction of the LED to the LED lead.

The maximum junction temperature of the Acrich2 LED package is 125 °C, therefore the maximum lead temperature T_{s_max} is

$$\begin{aligned}
 T_{s_max} &= T_{j_max} - (R\theta_{j-s} * P_d) \\
 &= 125^\circ\text{C} - (27^\circ\text{C/W} * 0.58\text{W}) = 109.34^\circ\text{C}
 \end{aligned}$$

Although this is the maximum lead temperature, it is recommended to keep the lead temperature under 70 °C.

Relative Spectral Distribution

Fig 1. Relative Spectral Distribution vs. Wavelength Characteristic – G, H

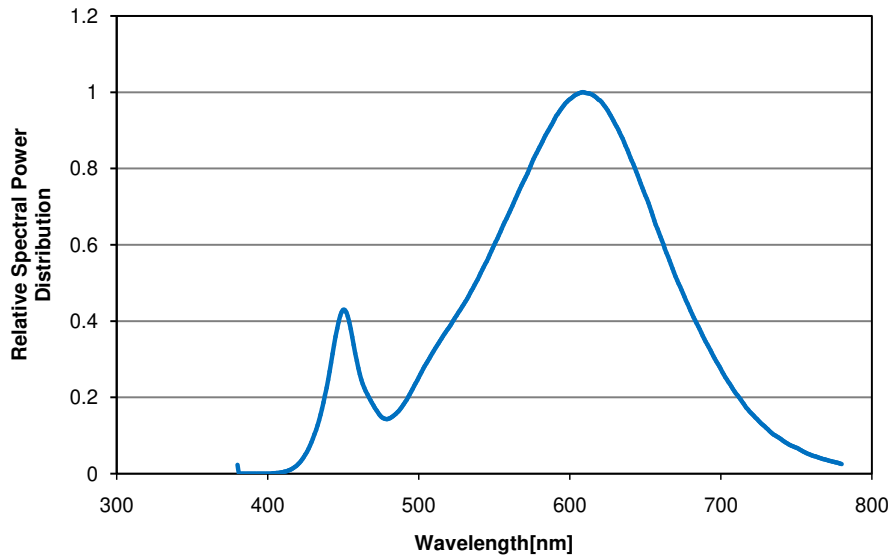
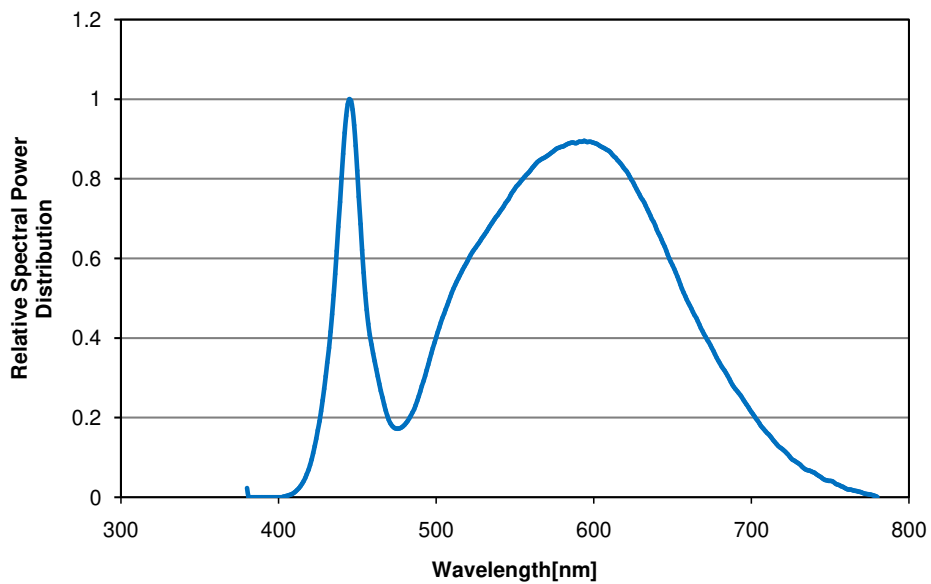
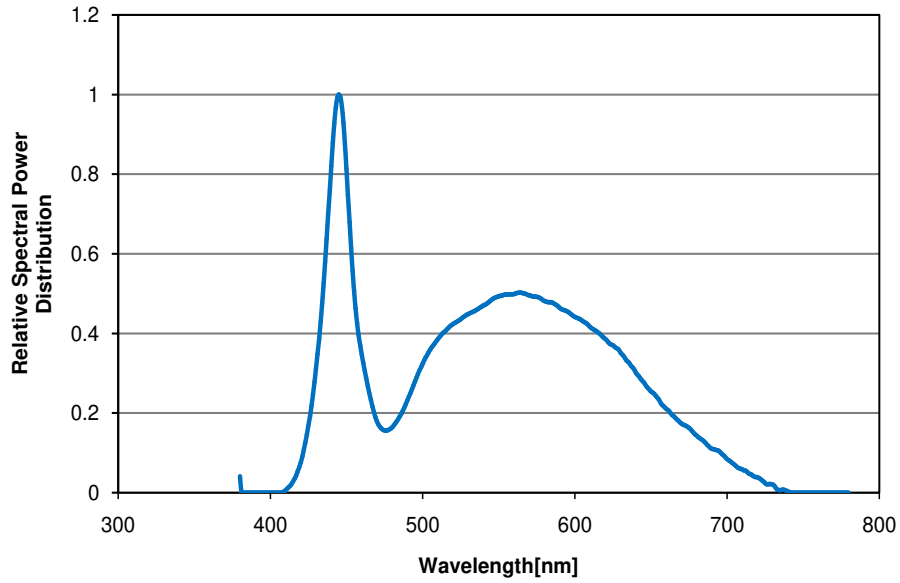

Fig 2. Relative Spectral Distribution vs. Wavelength Characteristic – E



Relative Spectral Distribution

Fig 3. Relative Spectral Distribution vs. Wavelength Characteristic – B, C

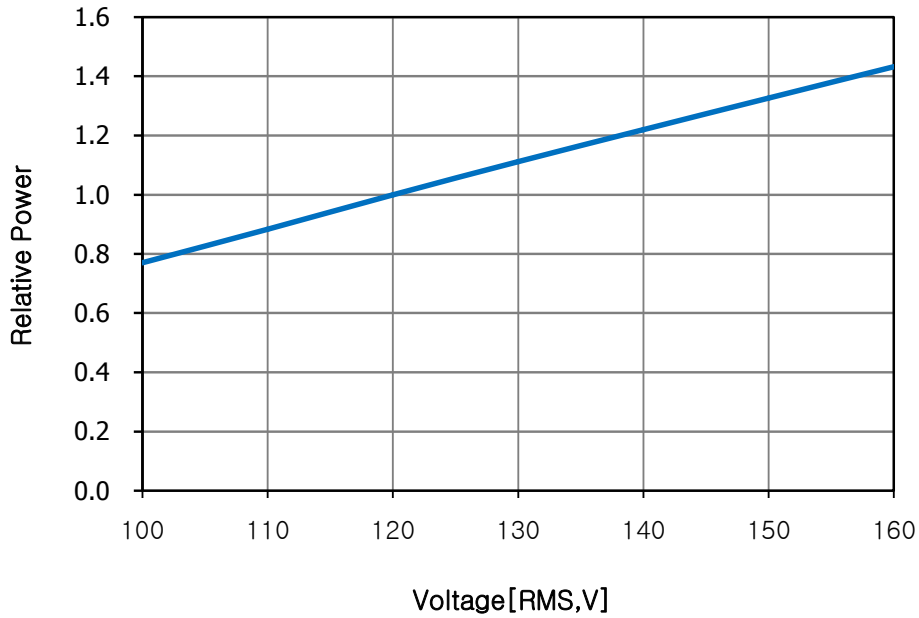
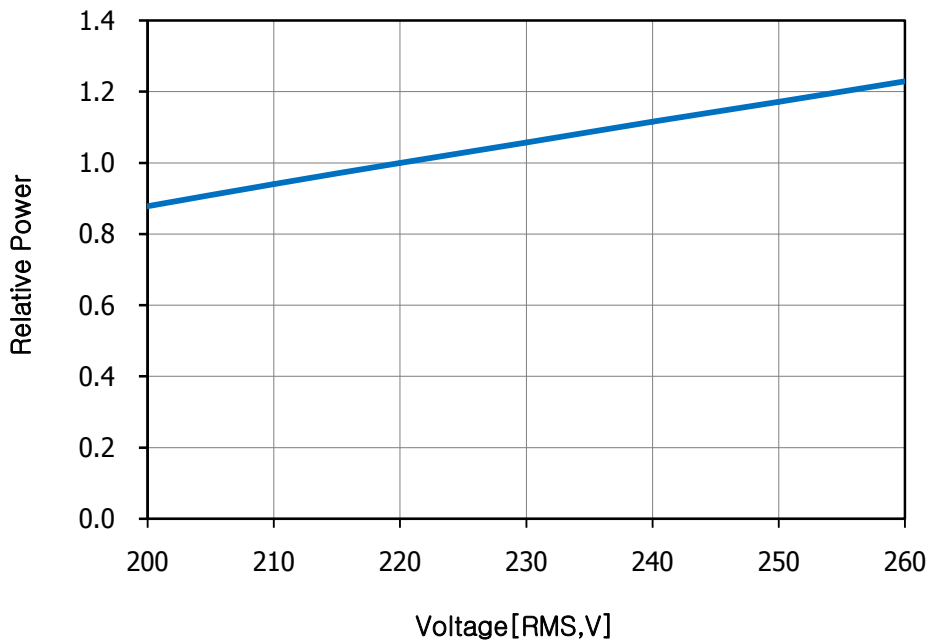

Relative Power Distribution

Fig 4. Relative Power Distribution vs. Voltage at $T_a = 25^\circ\text{C}$, 120V

Fig 5. Relative Power Distribution vs. Voltage at $T_a = 25^\circ\text{C}$, 220V

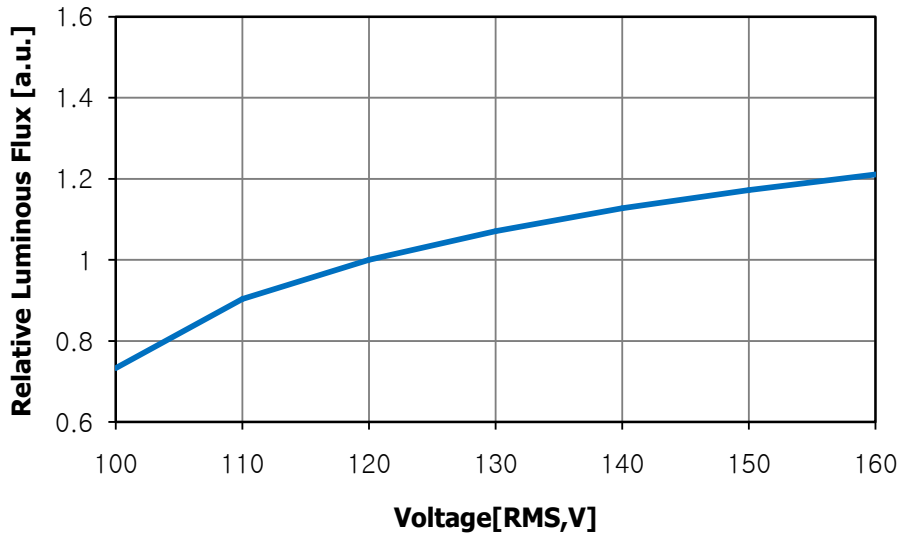
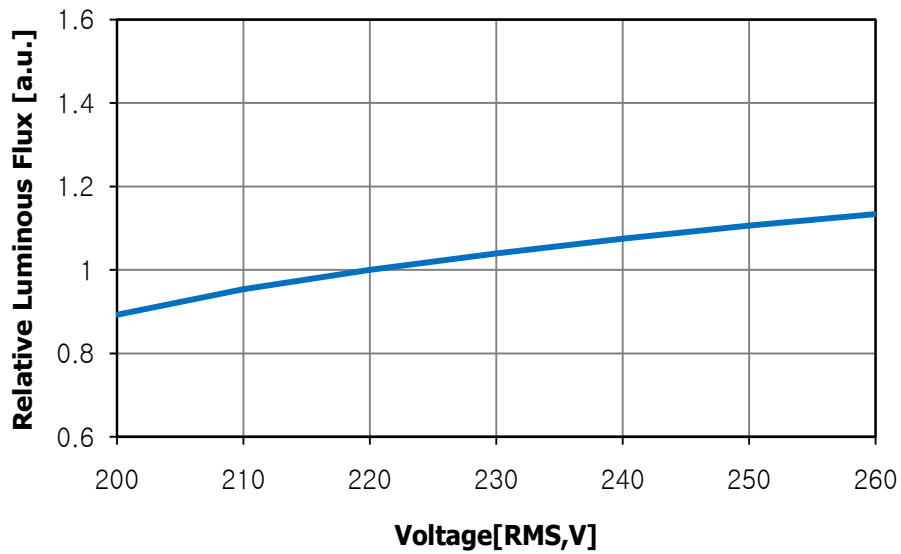
Relative Luminous Distribution

Fig 6. Relative Luminous Flux vs. Voltage at $T_a = 25^\circ\text{C}$, 120V

Fig 7. Relative Luminous Flux vs. Voltage at $T_a = 25^\circ\text{C}$, 220V

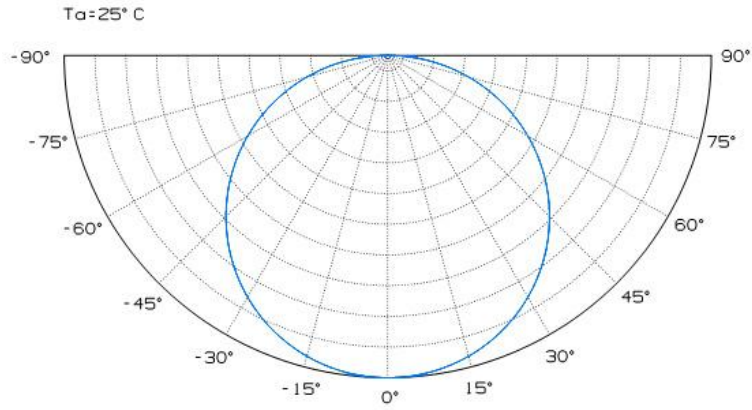
Luminous Flux Characteristics

Fig 8. Radiant Pattern, $T_a = 25^\circ\text{C}$



Color Bin Structure

CIE Chromaticity Diagram

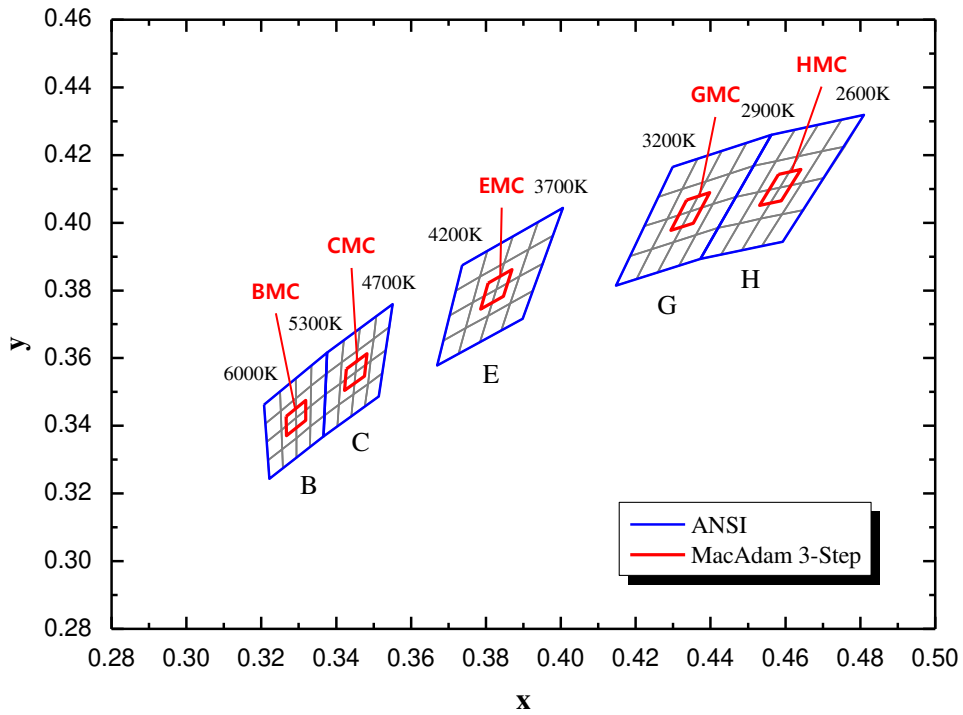

Bin	x	y	Bin	x	y	Bin	x	y
BMC	0.3266	0.3428	CMC	0.3427	0.3568	EMC	0.3806	0.3822
	0.3268	0.3371		0.3423	0.3504		0.3786	0.3745
	0.3319	0.3416		0.3476	0.3547		0.3846	0.3782
	0.3319	0.3476		0.3482	0.3613		0.3870	0.3861
GMC	0.4336	0.4067	HMC	0.4581	0.4143			
	0.4294	0.3977		0.4531	0.4051			
	0.4354	0.3999		0.4589	0.4065			
	0.4398	0.4089		0.4641	0.4157			

Color Bin Structure

CIE Chromaticity Diagram

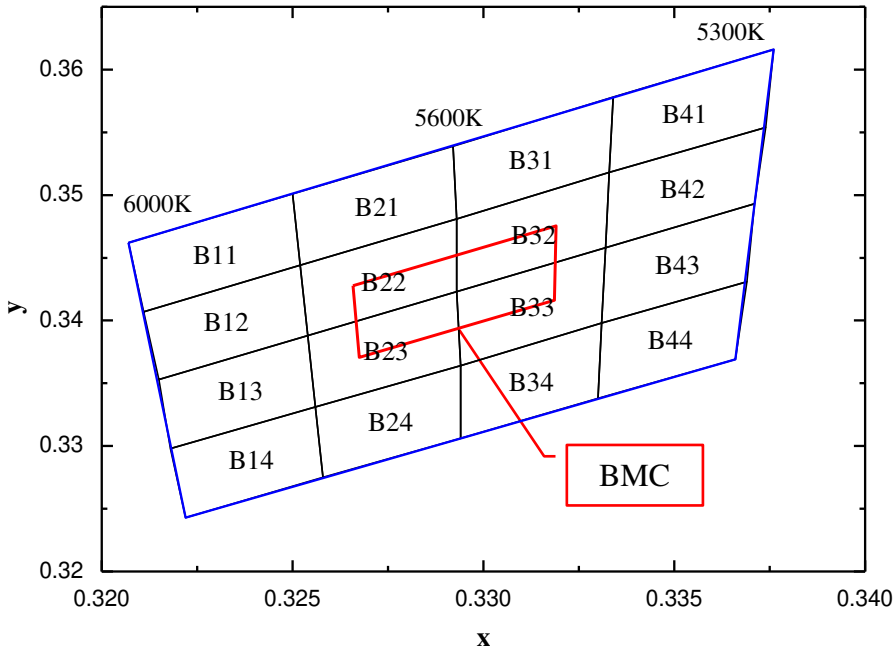

Bin	x	y	Bin	x	y	Bin	x	y	Bin	x	y
B11	0.3207	0.3462	B21	0.3250	0.3501	B31	0.3292	0.3539	B41	0.3334	0.3578
	0.3211	0.3407		0.3252	0.3444		0.3293	0.3481		0.3333	0.3518
	0.3252	0.3444		0.3293	0.3481		0.3333	0.3518		0.3374	0.3554
	0.3250	0.3501		0.3292	0.3539		0.3334	0.3578		0.3376	0.3616
B12	0.3211	0.3407	B22	0.3252	0.3444	B32	0.3293	0.3481	B42	0.3333	0.3518
	0.3215	0.3353		0.3254	0.3388		0.3293	0.3423		0.3332	0.3458
	0.3254	0.3388		0.3293	0.3423		0.3332	0.3458		0.3371	0.3493
	0.3252	0.3444		0.3293	0.3481		0.3333	0.3518		0.3374	0.3554
B13	0.3215	0.3353	B23	0.3254	0.3388	B33	0.3293	0.3423	B43	0.3332	0.3458
	0.3218	0.3298		0.3256	0.3331		0.3294	0.3364		0.3331	0.3398
	0.3256	0.3331		0.3294	0.3364		0.3331	0.3398		0.3369	0.3431
	0.3254	0.3388		0.3293	0.3423		0.3332	0.3458		0.3371	0.3493
B14	0.3218	0.3298	B24	0.3256	0.3331	B34	0.3294	0.3364	B44	0.3331	0.3398
	0.3222	0.3243		0.3258	0.3275		0.3294	0.3306		0.3330	0.3338
	0.3258	0.3275		0.3294	0.3306		0.3330	0.3338		0.3366	0.3369
	0.3256	0.3331		0.3294	0.3364		0.3331	0.3398		0.3369	0.3431

Color Bin Structure

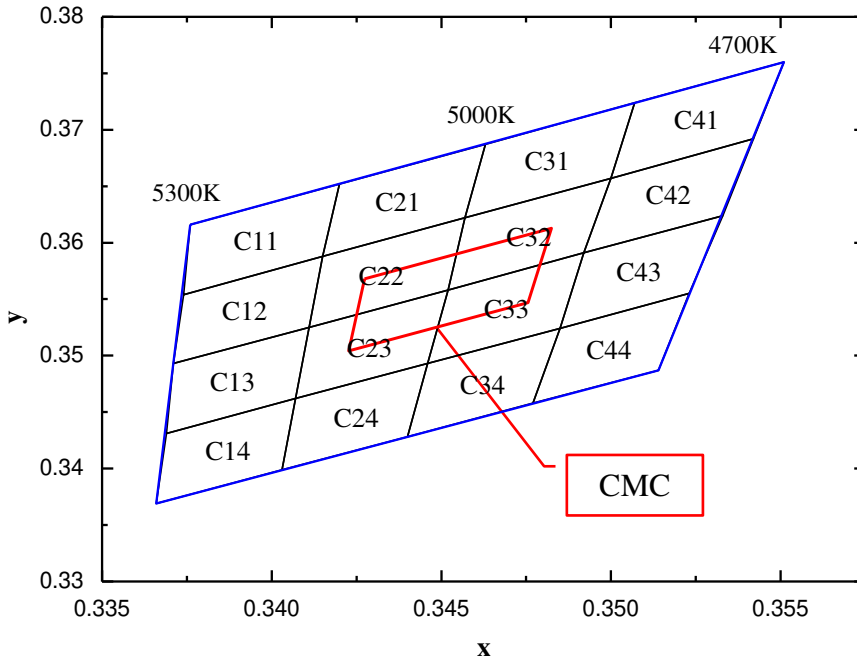
CIE Chromaticity Diagram

Bin	x	y	Bin	x	y	Bin	x	y	Bin	x	y
C11	0.3376	0.3616	C21	0.3420	0.3652	C31	0.3463	0.3687	C41	0.3507	0.3724
	0.3374	0.3554		0.3415	0.3588		0.3457	0.3622		0.3500	0.3657
	0.3415	0.3588		0.3457	0.3622		0.3500	0.3657		0.3542	0.3692
	0.3420	0.3652		0.3463	0.3687		0.3507	0.3724		0.3551	0.3760
C12	0.3374	0.3554	C22	0.3415	0.3588	C32	0.3457	0.3622	C42	0.3500	0.3657
	0.3371	0.3493		0.3411	0.3525		0.3452	0.3558		0.3492	0.3591
	0.3411	0.3525		0.3452	0.3558		0.3492	0.3591		0.3533	0.3624
	0.3415	0.3588		0.3457	0.3622		0.3500	0.3657		0.3542	0.3692
C13	0.3371	0.3493	C23	0.3411	0.3525	C33	0.3452	0.3558	C43	0.3492	0.3591
	0.3369	0.3431		0.3407	0.3462		0.3446	0.3493		0.3485	0.3524
	0.3407	0.3462		0.3446	0.3493		0.3485	0.3524		0.3523	0.3555
	0.3411	0.3525		0.3452	0.3558		0.3492	0.3591		0.3533	0.3624
C14	0.3369	0.3431	C24	0.3407	0.3462	C34	0.3446	0.3493	C44	0.3485	0.3524
	0.3366	0.3369		0.3403	0.3399		0.3440	0.3428		0.3477	0.3458
	0.3403	0.3399		0.3440	0.3428		0.3477	0.3458		0.3514	0.3487
	0.3407	0.3462		0.3446	0.3493		0.3485	0.3524		0.3523	0.3555

Color Bin Structure

CIE Chromaticity Diagram

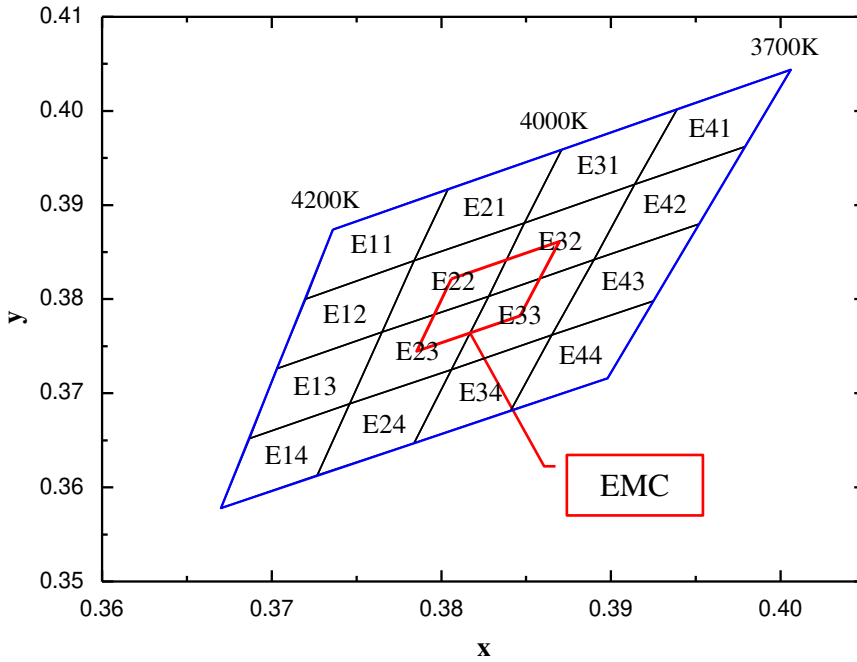

Bin	x	y	Bin	x	y	Bin	x	y	Bin	x	y
E11	0.3736	0.3874	E21	0.3804	0.3917	E31	0.3871	0.3959	E41	0.3939	0.4002
	0.3720	0.3800		0.3784	0.3841		0.3849	0.3881		0.3914	0.3922
	0.3784	0.3841		0.3849	0.3881		0.3914	0.3922		0.3979	0.3962
	0.3804	0.3917		0.3871	0.3959		0.3939	0.4002		0.4006	0.4044
E12	0.3720	0.3800	E22	0.3784	0.3841	E32	0.3849	0.3881	E42	0.3914	0.3922
	0.3703	0.3726		0.3765	0.3765		0.3828	0.3803		0.3890	0.3842
	0.3765	0.3765		0.3828	0.3803		0.3890	0.3842		0.3952	0.3880
	0.3784	0.3841		0.3849	0.3881		0.3914	0.3922		0.3979	0.3962
E13	0.3703	0.3726	E23	0.3765	0.3765	E33	0.3828	0.3803	E43	0.3890	0.3842
	0.3687	0.3652		0.3746	0.3689		0.3806	0.3725		0.3865	0.3762
	0.3746	0.3689		0.3806	0.3725		0.3865	0.3762		0.3925	0.3798
	0.3765	0.3765		0.3828	0.3803		0.3890	0.3842		0.3952	0.3880
E14	0.3687	0.3652	E24	0.3746	0.3689	E34	0.3806	0.3725	E44	0.3865	0.3762
	0.3670	0.3578		0.3727	0.3613		0.3784	0.3647		0.3841	0.3682
	0.3727	0.3613		0.3784	0.3647		0.3841	0.3682		0.3898	0.3716
	0.3746	0.3689		0.3806	0.3725		0.3865	0.3762		0.3925	0.3798

Color Bin Structure

CIE Chromaticity Diagram

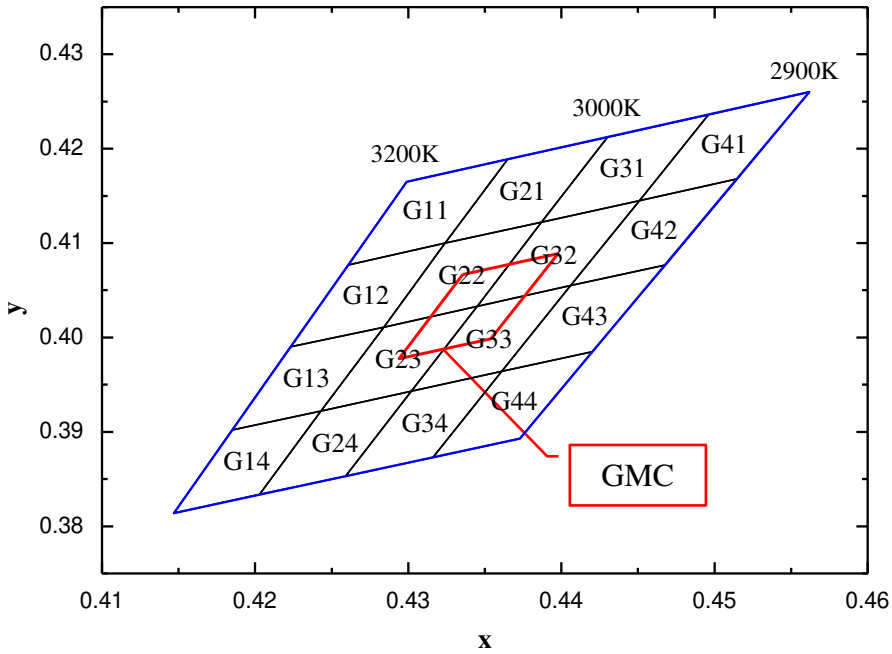

Bin	x	y	Bin	x	y	Bin	x	y	Bin	x	y
G11	0.4299	0.4165	G21	0.4364	0.4188	G31	0.4430	0.4212	G41	0.4496	0.4236
	0.4261	0.4077		0.4324	0.4099		0.4387	0.4122		0.4451	0.4145
	0.4324	0.4100		0.4387	0.4122		0.4451	0.4145		0.4514	0.4168
	0.4365	0.4189		0.4430	0.4212		0.4496	0.4236		0.4562	0.4260
G12	0.4261	0.4077	G22	0.4324	0.4100	G32	0.4387	0.4122	G42	0.4451	0.4145
	0.4223	0.3990		0.4284	0.4011		0.4345	0.4033		0.4406	0.4055
	0.4284	0.4011		0.4345	0.4033		0.4406	0.4055		0.4468	0.4077
	0.4324	0.4100		0.4387	0.4122		0.4451	0.4145		0.4515	0.4168
G13	0.4223	0.3990	G23	0.4284	0.4011	G33	0.4345	0.4033	G43	0.4406	0.4055
	0.4185	0.3902		0.4243	0.3922		0.4302	0.3943		0.4361	0.3964
	0.4243	0.3922		0.4302	0.3943		0.4361	0.3964		0.4420	0.3985
	0.4284	0.4011		0.4345	0.4033		0.4406	0.4055		0.4468	0.4077
G14	0.4243	0.3922	G24	0.4302	0.3943	G34	0.4302	0.3943	G44	0.4361	0.3964
	0.4203	0.3834		0.4259	0.3853		0.4259	0.3853		0.4316	0.3873
	0.4147	0.3814		0.4203	0.3834		0.4316	0.3873		0.4373	0.3893
	0.4185	0.3902		0.4243	0.3922		0.4361	0.3964		0.4420	0.3985

Color Bin Structure

CIE Chromaticity Diagram

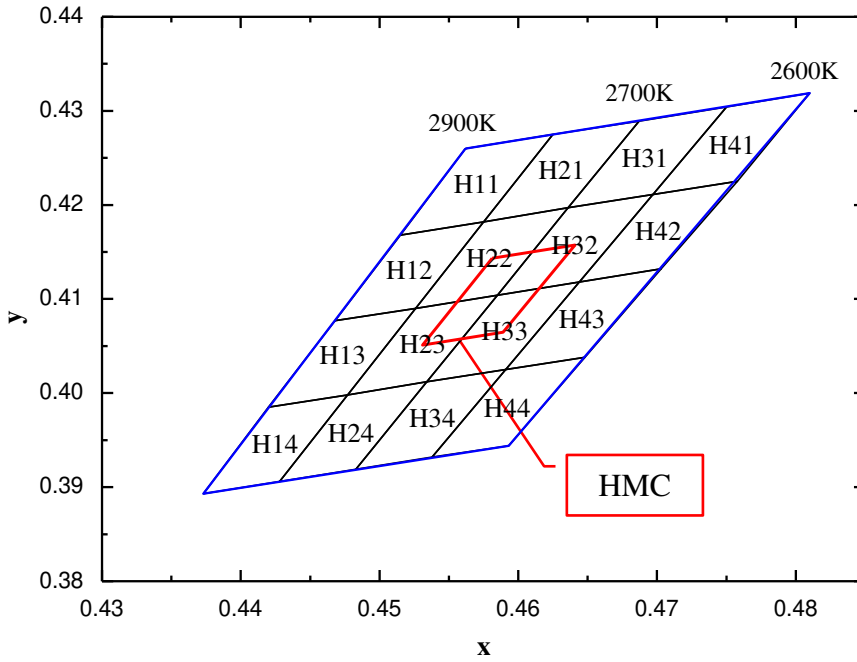

Bin	x	y	Bin	x	y	Bin	x	y	Bin	x	y
H11	0.4562	0.4260	H21	0.4625	0.4275	H31	0.4687	0.4289	H41	0.4750	0.4304
	0.4515	0.4168		0.4575	0.4182		0.4636	0.4197		0.4697	0.4211
	0.4575	0.4182		0.4636	0.4197		0.4697	0.4211		0.4758	0.4225
	0.4625	0.4275		0.4687	0.4289		0.4750	0.4304		0.4810	0.4319
H12	0.4515	0.4168	H22	0.4575	0.4182	H32	0.4636	0.4197	H42	0.4697	0.4211
	0.4468	0.4077		0.4526	0.4090		0.4585	0.4104		0.4644	0.4118
	0.4526	0.4090		0.4585	0.4104		0.4644	0.4118		0.4703	0.4132
	0.4575	0.4182		0.4636	0.4197		0.4697	0.4211		0.4758	0.4225
H13	0.4468	0.4077	H23	0.4526	0.4090	H33	0.4585	0.4104	H43	0.4644	0.4118
	0.4420	0.3985		0.4477	0.3998		0.4534	0.4012		0.4591	0.4025
	0.4477	0.3998		0.4534	0.4012		0.4591	0.4025		0.4648	0.4038
	0.4526	0.4090		0.4585	0.4104		0.4644	0.4118		0.4703	0.4132
H14	0.4420	0.3985	H24	0.4477	0.3998	H34	0.4534	0.4012	H44	0.4591	0.4025
	0.4373	0.3893		0.4428	0.3906		0.4483	0.3919		0.4538	0.3932
	0.4428	0.3906		0.4483	0.3919		0.4538	0.3932		0.4593	0.3944
	0.4477	0.3998		0.4534	0.4012		0.4591	0.4025		0.4648	0.4038

Part List

Table 5. Part List

No	Part	Reference	Specification	Quantity
1	PCB	-	Al, ø50, T=1.6, 1 layer / Cu 1oz / White PSR	1
2	LED	-	SAW8KG0B	30
3	IC	U1, U2	MAH3082 @ 120Vac	2
			MAH3080 @ 220Vac	

Mechanical Dimensions

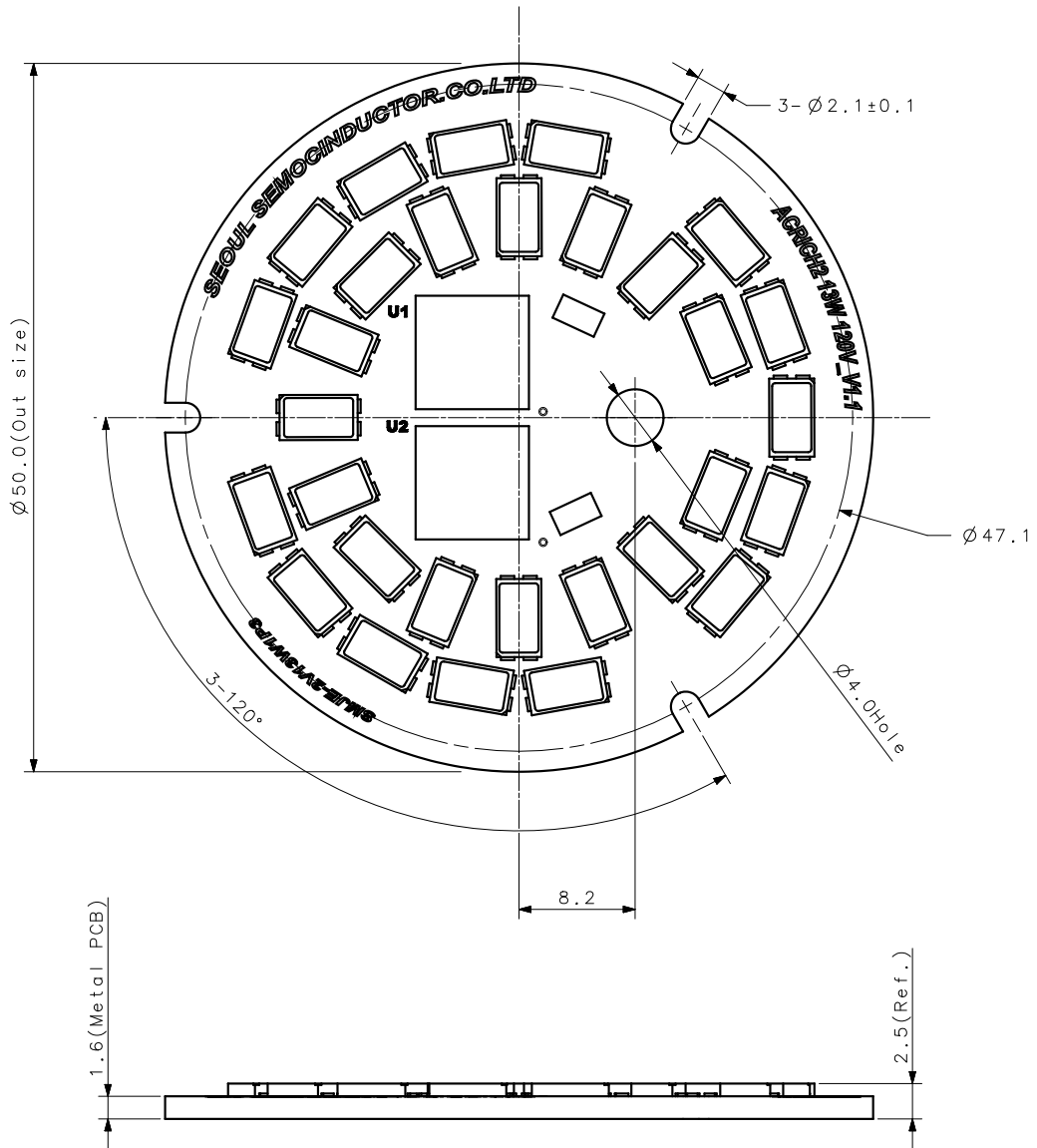

Notes :

- (1) All dimensions are in millimeters. (Tolerance : ± 0.2)
- (2) Scale : None

Circuit Drawing

SMJE-2V12W1P3 (120V)

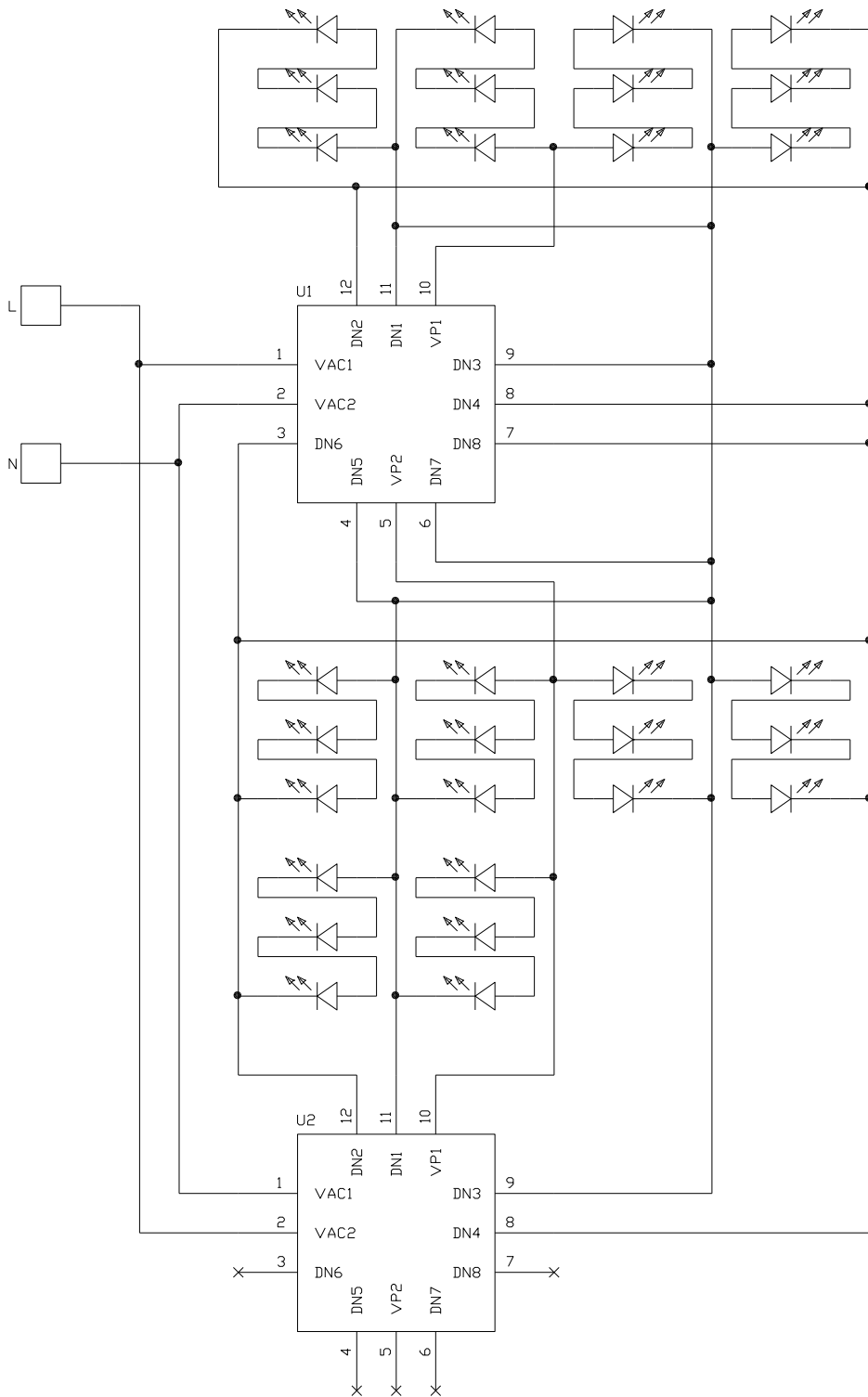

Circuit Drawing

SMJE-3V12W1P3 (220V)

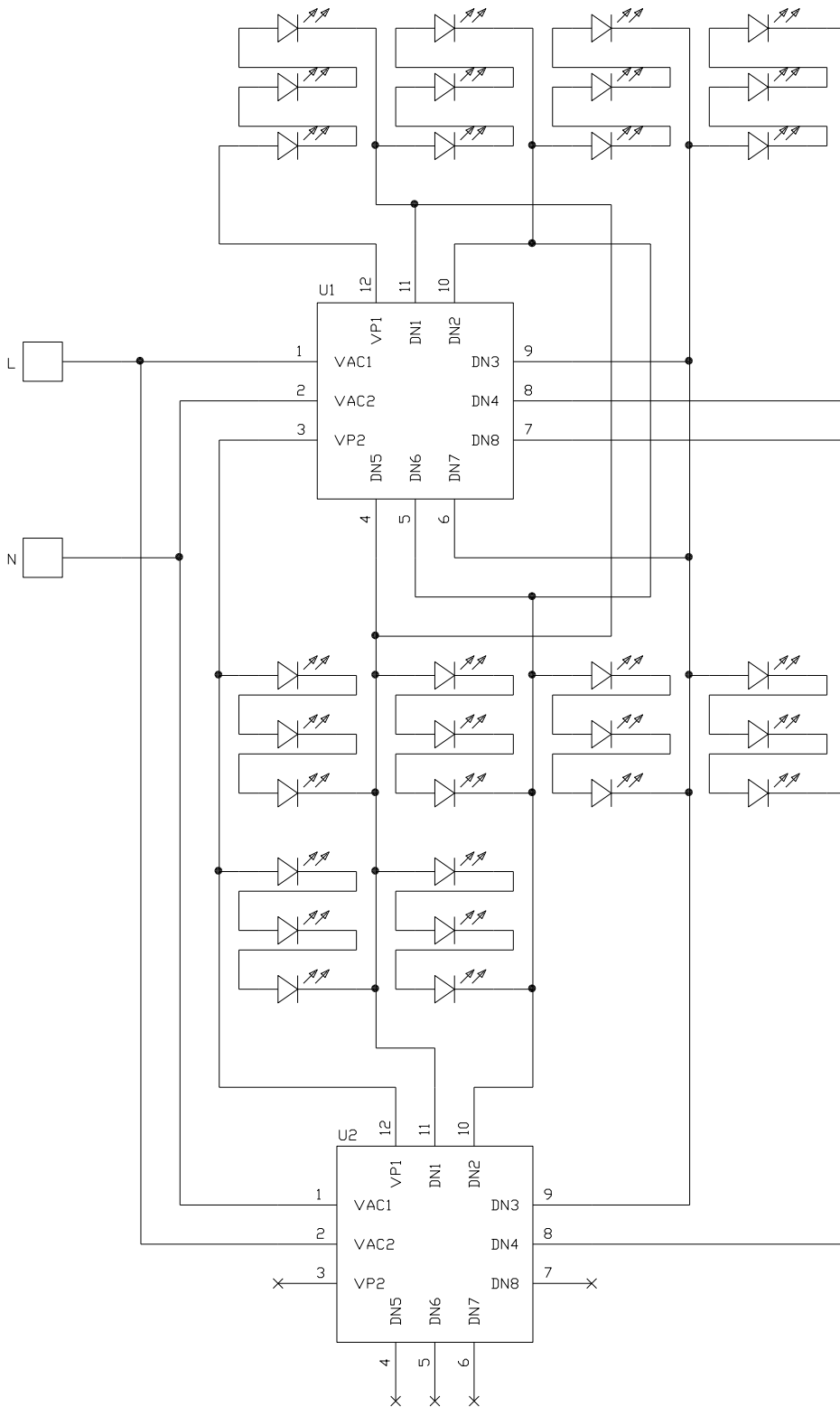

Marking Information

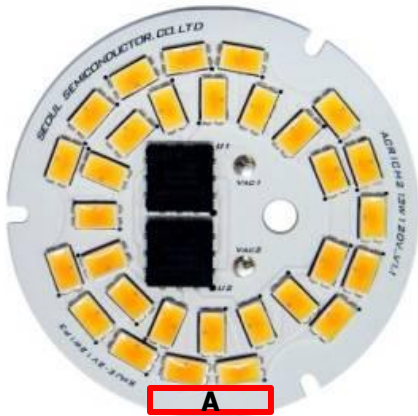

A : Marking

(1) Single Bin

A : ex) 140101 Z4G32

- Description

1 4 0 1 0 1 Z 4 G 3 2
 ① ② ③

- ① SMT Date (YYMMDD, 6 Digits)
- ② LED PKG. Luminous Intensity Bin (2 Digits)
- ③ LED PKG. Color Bin (3 Digits)

(2) Combination Bin

A : ex) 140101 13bG11

- Description

1 4 0 1 0 1 1 3 b G 1 1
 ① ⑤
 ④
 ③
 ②

- ① SMT Date (YYMMDD, 6 Digits)
- ② Module Flux Bin (3 Digits)
- ③ CCT (1 Digit)
- ④ CCT Combination NO. (1 Digit)
- ⑤ VF Combination NO. (1 Digit)

② Module Flux Bin				③ CCT				④ CCT Combination			⑤ VF Combination		
Mark	Min.	Typ.	Max.	Mark	Min.	Typ.	Max.	Mark	Bin1	Bin2	Mark	Bin1	Bin2
13a	880	1000	1140	B	5300	5600	6000	0	22	33	1	A	A
13b	1140	1210	1300	C	4700	5000	5300	1	23	32	2	A	B
				E	3700	4000	4200	2	33	22	3	B	A
				G	2900	3000	3200	3	32	23	4	A	C
				H	2600	2700	2900	4	MC	MC	5	C	A
											6	B	B
											7	B	C
											8	C	B
											9	C	C

Packing

1. Tray information

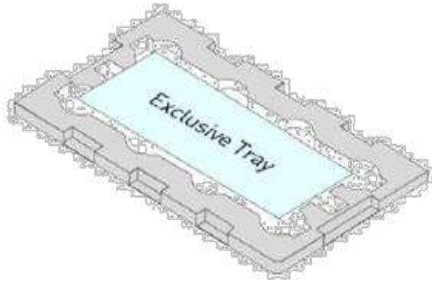

- 50 PCS LED modules packed per tray

2. Tray stack and taping

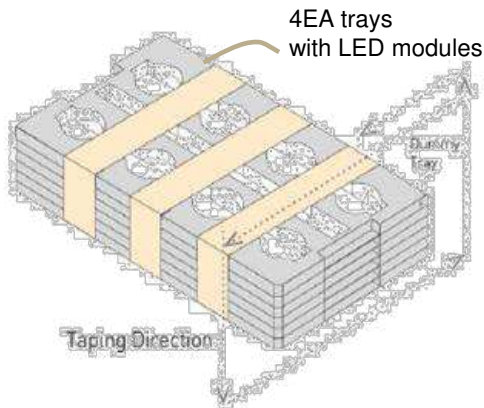

- 4 LED module trays and additional 2 dummy trays each up and down of box
- Add silica gel (1EA) on top of the tray

3. Sealing packing

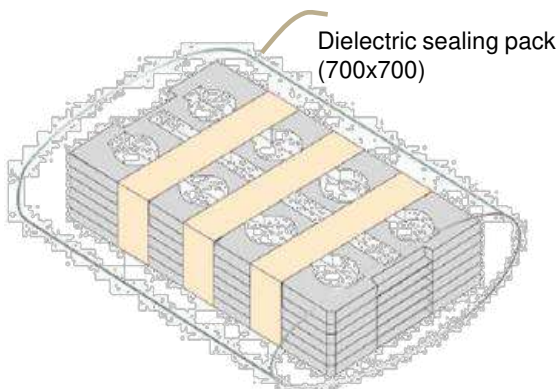

4. Box information & packing

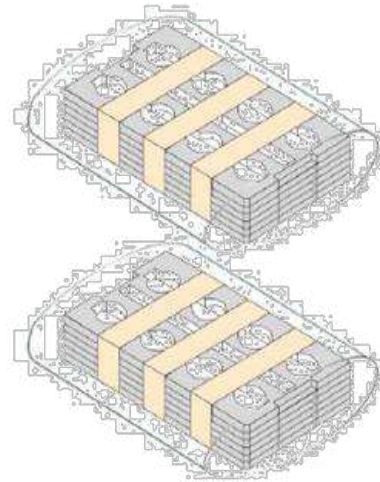

- 400 PCS modules per BOX 1EA

** 1 Box : 50 PCS per tray x 8 trays = 400 PCS

Label Information

Model No.	SMJE-XV12W1P3 ⁽¹⁾
Rank	XXXXXXXX ⁽²⁾
Type	STD / 3-Step ⁽³⁾
Quantity	XX
Lot No.	YYMDDXXXXX-XXXXXXXX
	SEOUL SEMICONDUCTOR CO.,LTD.

Notes

- (1) The model number designation is explained as follow
 SMJE : Seoul Semiconductor internal code
 XV : Input Voltage (2V = 120V, 3V = 220V)
 12W : About Power Consumption
 1 : Acrich IC Version
 P3 : MJT PKG (SAW8KG0B)
- (2) It represents the LED module rank.
 ALL : Single Bin, 13a/13b : Combination Bin
 X06/X16 : Each Sub-Bin NO. (X = CCT)
 A : Single Bin, M : Combination Bin(3-Step)
- (3) It represents single bin(STD) or MacAdam 3-Step(3-Step).
- (4) It is attached to the top of a sealing pack & the bottom right corner of the box.

<p>TOTAL Quantity</p> <p> </p> <p>XX</p>
 SEOUL SEMICONDUCTOR CO.,LTD.

Notes

- (1) It is attached to the bottom right corner of the box.

Handling of Silicone Resin for LEDs

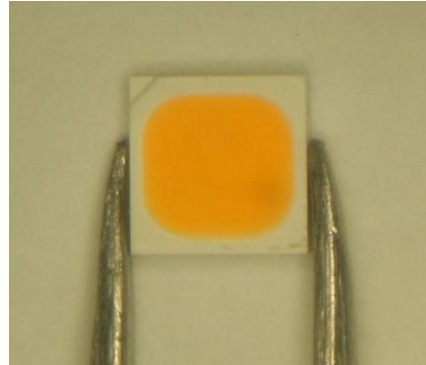
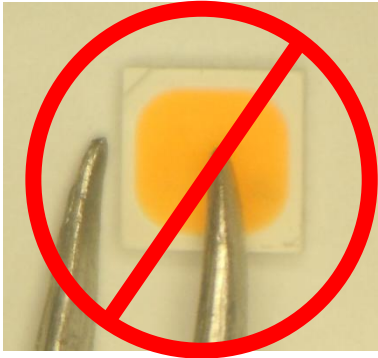

- (1) Acrich2 series is encapsulated with silicone resin for high optical efficiency.
- (2) Please do not touch the silicone resin area with sharp objects such as pincette(tweezers).
- (3) Finger prints on silicone resin area may affect the performance.
- (4) Please store LEDs in covered containers to prevent dust accumulation as this may affect performance.
- (5) Excessive force more than 3000gf to the silicone lens can result in fatal or permanent damage with LEDs.
- (6) Please do not cover the silicone resin area with any other resins such as epoxy, urethane, etc.

Precaution for Use

- (1) Please review the Acrich2 Application Note for proper protective circuitry usage.
- (2) Please note, Acrich2 products run off of high voltage, therefore caution should be taken when working near Acrich2 products.
- (3) Make sure proper discharge prior to starting work.
- (4) DO NOT touch any of the circuit board, components or terminals with body or metal while circuit is active.
- (5) Please do not add or change wires while Acrich2 circuit is active.
- (6) Long time exposure to sunlight or UV can cause the lens to discolor.
- (7) Please do not use adhesives to attach the LED that outgas organic vapor.
- (8) Please do not use together with the materials containing Sulfur.
- (9) Please do not assemble in conditions of high moisture and/or oxidizing gas such as Cl, H₂S, NH₃, SO₂, NO_x, etc.
- (10) Please do not make any modification on module.
- (11) Please be cautious when soldering to board so as not to create a short between different trace patterns.
- (12) Do not impact or place pressure on this product because even a small amount of pressure can damage the product. The product should also not be placed in high temperatures, high humidity or direct sunlight since the device is sensitive to these conditions.
- (13) When storing devices for a long period of time before usage, please following these guidelines:
 - * The devices should be stored in the anti-static bag that it was shipped in from Seoul-Semiconductor with opening.
 - * If the anti-static bag has been opened, re-seal preventing air and moisture from being present in the bag.
- (14) LEDs and IC are sensitive to Electro-Static Discharge (ESD) and Electrical Over Stress (EOS). The Acrich2 product should also not be installed in end equipment without ESD protection. Below is a list of suggestions that Seoul Semiconductor purposes to minimize these effects.

a. ESD (Electro Static Discharge)

Electrostatic discharge (ESD) is the defined as the release of static electricity when two objects come into contact. While most ESD events are considered harmless, it can be an expensive problem in many industrial environments during production and storage. The damage from ESD to an LEDs may cause the product to demonstrate unusual characteristics such as: