



Chipsmall Limited consists of a professional team with an average of over 10 year of expertise in the distribution of electronic components. Based in Hongkong, we have already established firm and mutual-benefit business relationships with customers from,Europe,America and south Asia,supplying obsolete and hard-to-find components to meet their specific needs.

With the principle of “Quality Parts,Customers Priority,Honest Operation,and Considerate Service”,our business mainly focus on the distribution of electronic components. Line cards we deal with include Microchip,ALPS,ROHM,Xilinx,Pulse,ON,Everlight and Freescale. Main products comprise IC,Modules,Potentiometer,IC Socket,Relay,Connector.Our parts cover such applications as commercial,industrial, and automotives areas.

We are looking forward to setting up business relationship with you and hope to provide you with the best service and solution. Let us make a better world for our industry!



## Contact us

Tel: +86-755-8981 8866 Fax: +86-755-8427 6832

Email & Skype: info@chipsmall.com Web: www.chipsmall.com

Address: A1208, Overseas Decoration Building, #122 Zhenhua RD., Futian, Shenzhen, China



Integrated Lens Solution

**DC Lens bar Module – 6W**

## Product Brief

### Description

- DC Lens bar modules are designed to minimize the number of LED, therefore they provide a cost reduction solution when applied at flat lighting.
- This modules will also allow for a more slim design with weight reduction than general direct type modules.

### Features and Benefits

- Allow the slim design
- Minimize the number of LED
- Best uniformity
- Allow the weight reduction
- Lead Free product
- RoHS compliant

### Key Applications

- Flat light

**Table 1-1. Product Selection(CCT)**

Part No.	P [W]	VF [V]	IF [mA]	Color	CCT[K]	CRI
						Min.
SMJF-LF08E00-XX	5.6 ~ 6.1	47 ~ 51	120	Neutral	3,700 ~ 4,200	80
SMJF-LF08D00-XX					4,200 ~ 4,700	
SMJF-LF08C00-XX				Cool	4,700 ~ 5,300	
SMJF-LF08B00-XX					5,300 ~ 6,000	
SMJF-LF08A00-XX					6,000 ~ 7,000	

**Table 1-2. Product Selection(Flux)**

Part No.	P [W]	VF [V]	IF [mA]	Flux[lm]	
				Min.	Typ.
SMJF-LF08E00-XX	5.6 ~ 6.1	47 ~ 51	120	675	-
SMJF-LF08D00-XX					-
SMJF-LF08C00-XX				684	-
SMJF-LF08B00-XX					-
SMJF-LF08A00-XX					-

---

## Table of Contents

### Index

- Product Brief
- Table of Contents
- Optical and Electrical Characteristics
  - Performance Characteristics
  - Absolute Maximum Ratings
  - Thermal Resistance
  - Relative Spectral Distribution
  - Forward current Characteristics
  - Luminous Flux Characteristics
- Color Bin Specification
- Part List
- Packaging Information
  - Marking
  - Mechanical Dimensions
  - Circuit Drawing
  - Packing & Label Information
- Precaution For Use
- Handling of Silicone Resin for LEDs
- Handling with regards to static electricity
- Storage before use
- Company Information
- Revision History

## Performance Characteristics

**Table2. Electro Optical Characteristics,  $T_A = 25^\circ\text{C}$** 

Parameter	Symbol	Mark	Value			Unit
			Min.	Typ.	Max.	
Luminous Flux [2]	$\Phi_V$ [3]	-	675		-	lm
Correlated Color Temperature [4]	CCT	E	3,700	4,000	4,200	K
		D	4,200	4,500	4,700	
		C	4,700	5,000	5,300	
		B	5,300	5,600	6,000	
		A	6,000	6,500	7,000	
CRI	$R_a$		80	-	-	-
Operating Voltage [5]	$V_{opt}$		47	-	51	
Power Dissipation	$P_D$		5.6	-	6.1	W
View Angle	$2\theta$ 1/2		150			deg.

**Notes :**

1. LF08x00 series maintain the tolerance of 10% on flux and power measurements.
2.  $\Phi_V$  is the total luminous flux output measured with an integrated sphere.
3. Correlated Color Temperature is derived from the CIE 1931 Chromaticity diagram.

## Absolute Maximum Ratings

**Table3. Absolute Maximum Ratings, TA = 25°C**

Parameter	Symbol	Value	Unit
Max. Voltage	$V_F$	200	mA
Power Dissipation	$P_d$	10.4	W
Operating Temperature	$T_{opr}$	-10 ~ 85	°C
Storage Temperature	$T_{stg}$	-40 ~ 85	°C
ESD Sensitivity	-	±5,000V	-

Preliminary Specification

**Notes :**

1. A zener diode is included to protect the product from ESD.





## Thermal Resistance

Part	Package Power Dissipation [W]	Maximum Junction Temp[°C]	R $\theta_{j-s}$ [°C/W]
LED	STW8C2SA Max 1.44	125	10

The LED has a thermal resistance of 10 °C/W from junction of the LED to the LED lead.

The maximum junction temperature of the LED package is 125 °C, therefore the maximum lead temperature T<sub>s\_max</sub> is

$$T_{s\_max} = T_{j\_max} - (R_{\theta_{j-s}} * P_D)$$
$$= 125\text{ °C} - (10\text{ °C/W} * 1.44\text{W}) = 110.6\text{ °C}$$

Although this is the maximum lead temperature, it is recommended to keep the lead temperature under 90 °C

## Relative Spectral Distribution

Fig 1-1. Relative Spectral Distribution vs. Wavelength Characteristic – 3700K, 4700K

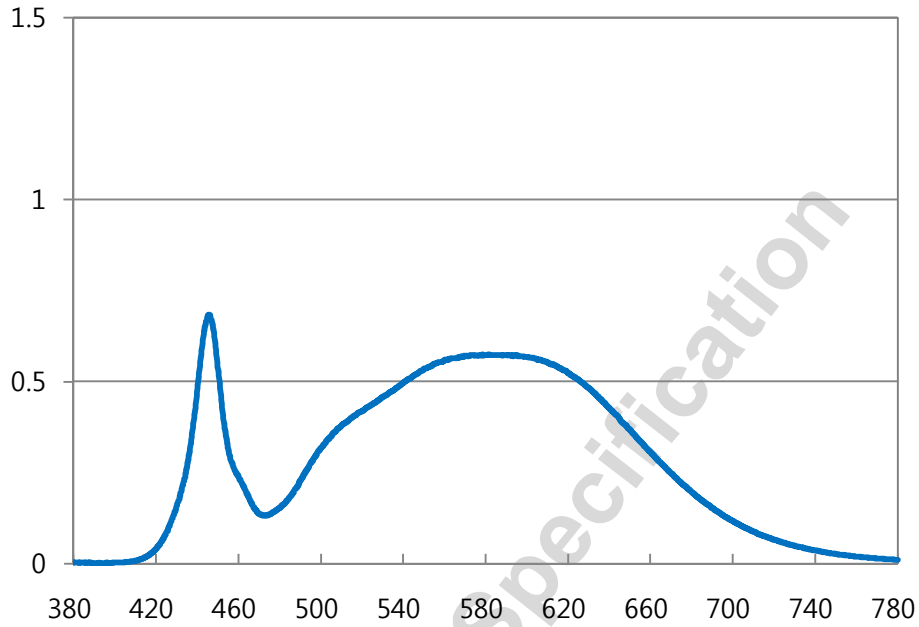
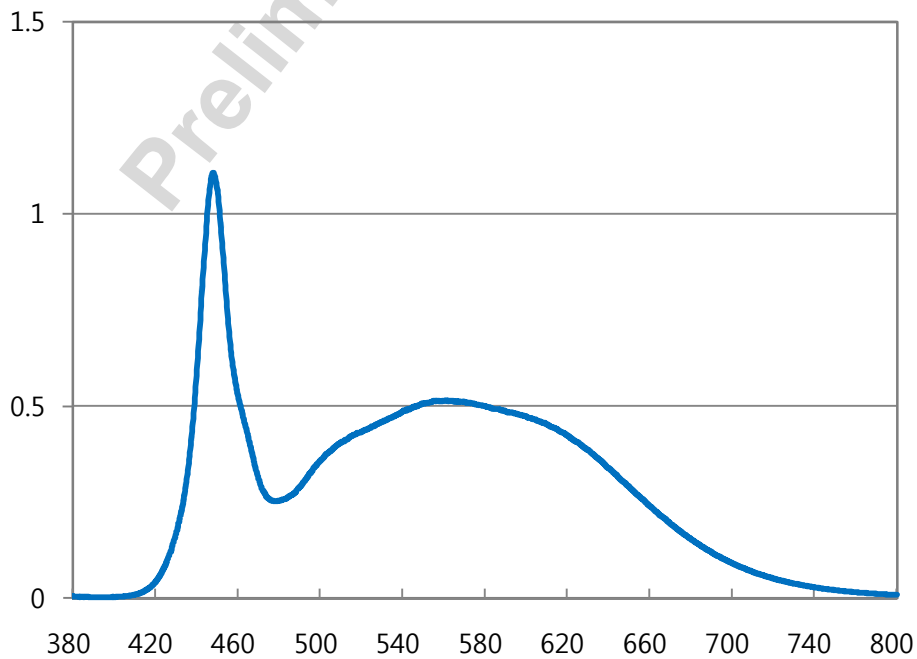
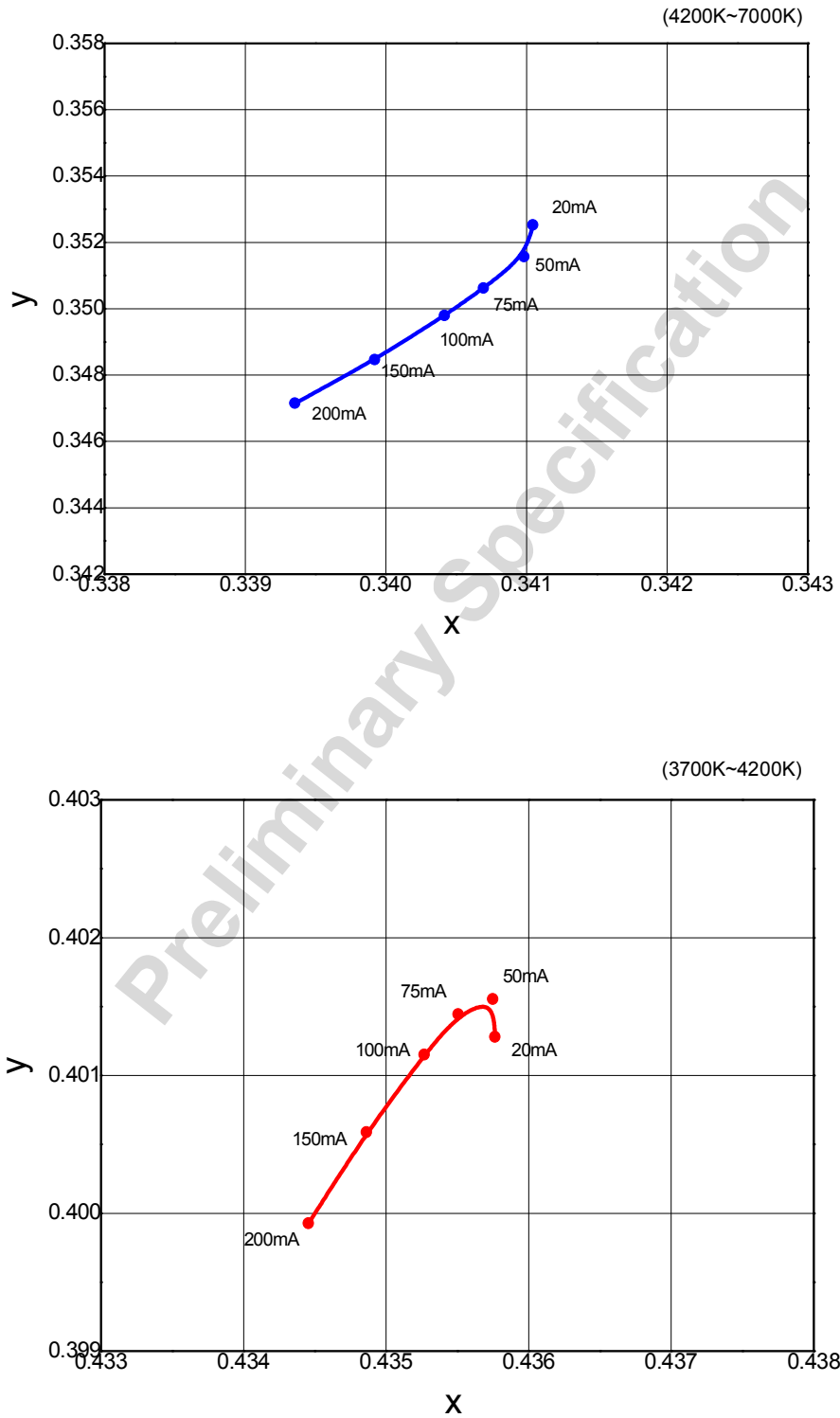

Fig 1-2. Relative Spectral Distribution vs. Wavelength Characteristic – 4700K, 7000K



## Forward Current Characteristics

Fig 2. Forward Current vs. CIE X, Y Shift ,  $T_a = 25^\circ\text{C}$ ,



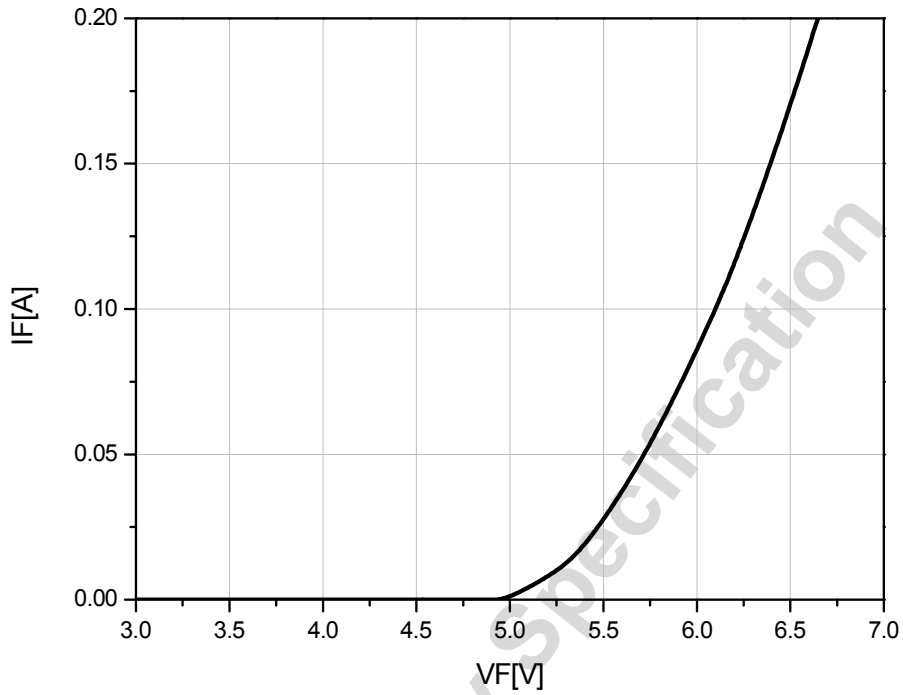
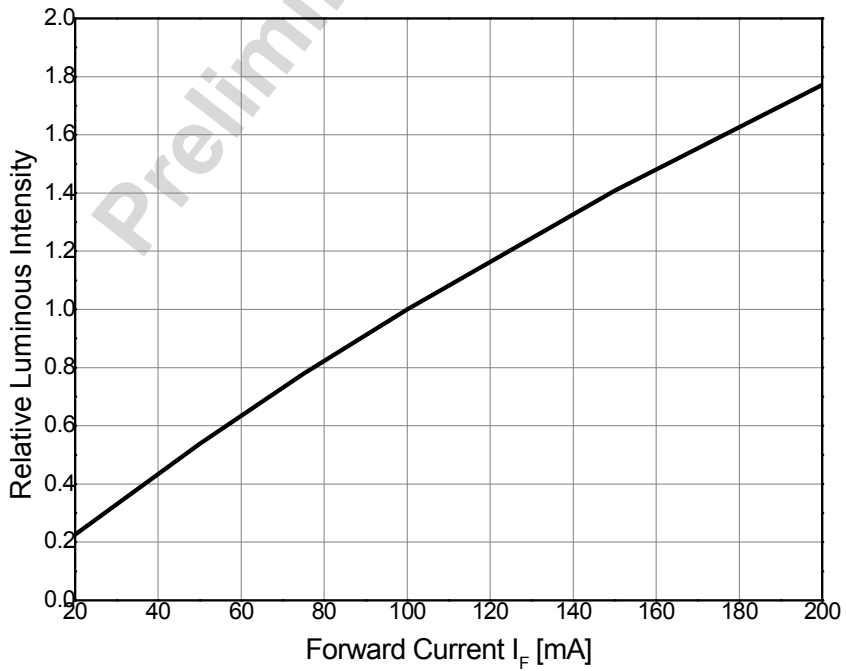

## Forward Current Characteristics

**Fig 3-1. Forward Voltage vs. Forward Current , Ta=25°C (@LED)**

**Fig 3-2. Forward Current vs. Relative Luminous Flux, Ta=25°C**

## Luminous Flux Characteristics

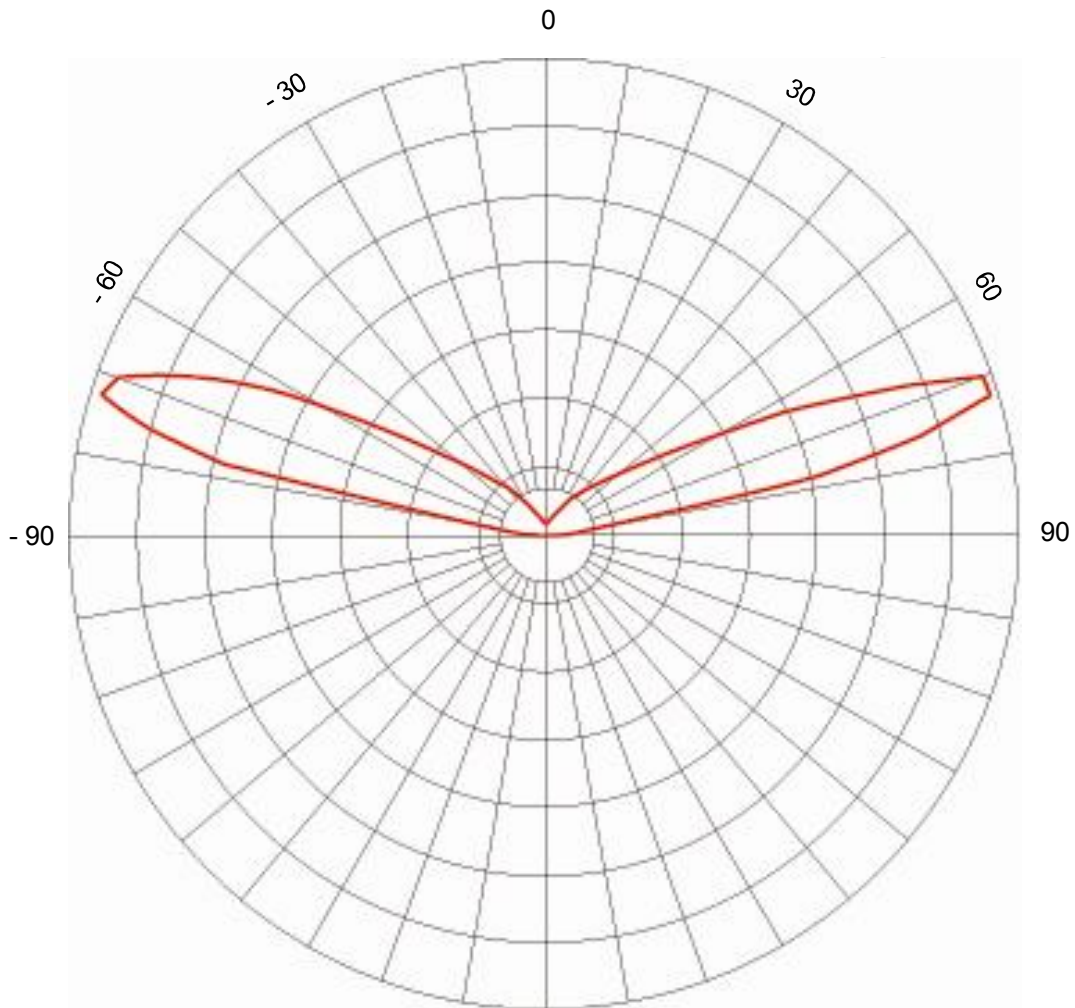
Fig 4. Radiant pattern,  $T_a=25^{\circ}\text{C}$



## Color Bin Structure

Fig 5. CIE Chromaticity Diagram Ta = 25°C, IF = 100mA

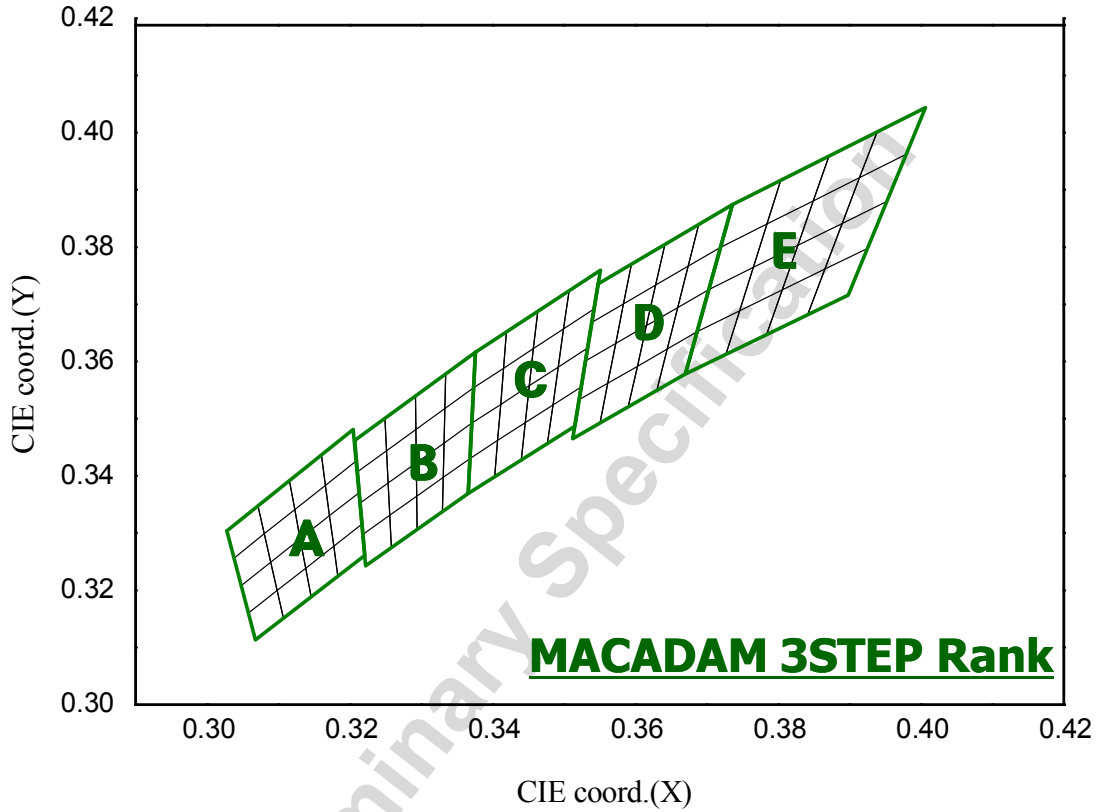

## Color Bin Structure

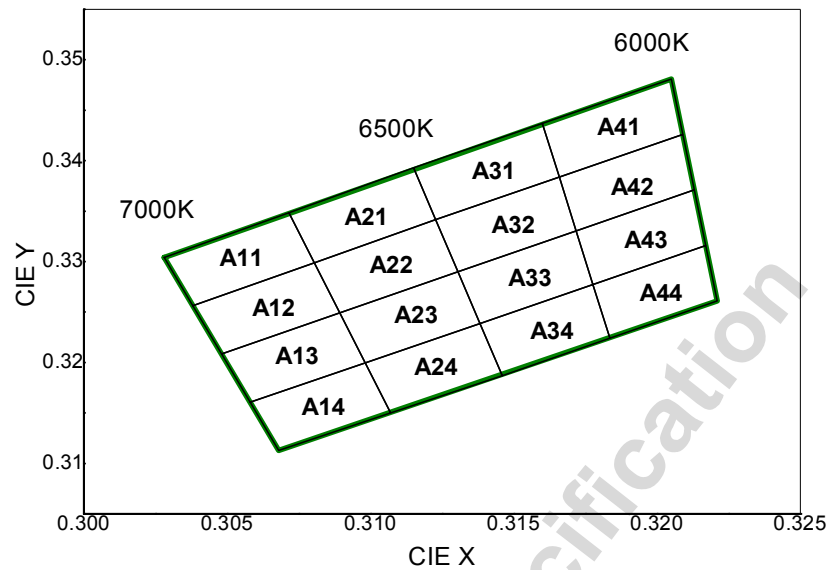
 $\langle I_f = 100\text{mA}, T_a = 25^\circ\text{C} \rangle$ 

A11		A21		A31		A41	
CIE X	CIE Y	CIE X	CIE Y	CIE X	CIE Y	CIE X	CIE Y
0.3028	0.3304	0.3072	0.3349	0.3115	0.3393	0.3160	0.3437
0.3038	0.3256	0.3080	0.3299	0.3123	0.3342	0.3166	0.3384
0.3080	0.3299	0.3123	0.3342	0.3166	0.3384	0.3209	0.3426
0.3072	0.3349	0.3115	0.3393	0.3160	0.3437	0.3205	0.3481
A12		A22		A32		A42	
CIE X	CIE Y	CIE X	CIE Y	CIE X	CIE Y	CIE X	CIE Y
0.3038	0.3256	0.3080	0.3299	0.3123	0.3342	0.3166	0.3384
0.3048	0.3209	0.3089	0.3249	0.3131	0.3290	0.3172	0.3331
0.3089	0.3249	0.3131	0.3290	0.3172	0.3331	0.3213	0.3371
0.3080	0.3299	0.3123	0.3342	0.3166	0.3384	0.3209	0.3426
A13		A23		A33		A43	
CIE X	CIE Y	CIE X	CIE Y	CIE X	CIE Y	CIE X	CIE Y
0.3048	0.3209	0.3089	0.3249	0.3131	0.3290	0.3172	0.3331
0.3058	0.3161	0.3098	0.3200	0.3138	0.3239	0.3178	0.3277
0.3098	0.3200	0.3138	0.3239	0.3178	0.3277	0.3217	0.3316
0.3089	0.3249	0.3131	0.3290	0.3172	0.3331	0.3213	0.3371
A14		A24		A34		A44	
CIE X	CIE Y	CIE X	CIE Y	CIE X	CIE Y	CIE X	CIE Y
0.3058	0.3161	0.3098	0.3200	0.3138	0.3239	0.3178	0.3277
0.3068	0.3113	0.3107	0.3150	0.3146	0.3187	0.3184	0.3224
0.3107	0.3150	0.3146	0.3187	0.3184	0.3224	0.3221	0.3261
0.3098	0.3200	0.3138	0.3239	0.3178	0.3277	0.3217	0.3316

## Color Bin Structure

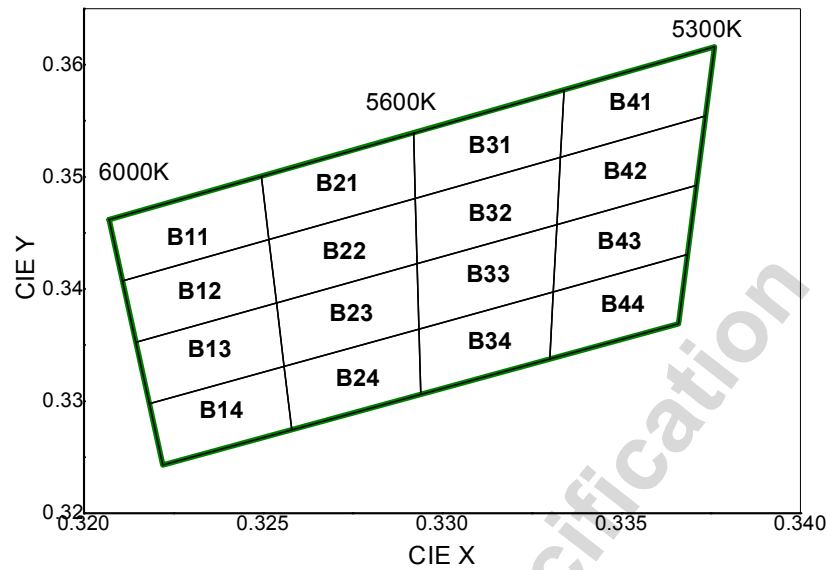
 $\langle I_F = 100\text{mA}, T_a = 25^\circ\text{C} \rangle$ 

B11		B21		B31		B41	
CIE X	CIE Y	CIE X	CIE Y	CIE X	CIE Y	CIE X	CIE Y
0.3207	0.3462	0.3250	0.3501	0.3292	0.3539	0.3334	0.3578
0.3211	0.3407	0.3252	0.3444	0.3293	0.3481	0.3333	0.3518
0.3252	0.3444	0.3293	0.3481	0.3333	0.3518	0.3374	0.3554
0.3250	0.3501	0.3292	0.3539	0.3334	0.3578	0.3376	0.3616
B12		B22		B32		B42	
CIE X	CIE Y	CIE X	CIE Y	CIE X	CIE Y	CIE X	CIE Y
0.3211	0.3407	0.3252	0.3444	0.3293	0.3481	0.3333	0.3518
0.3215	0.3353	0.3254	0.3388	0.3293	0.3423	0.3332	0.3458
0.3254	0.3388	0.3293	0.3423	0.3332	0.3458	0.3371	0.3493
0.3252	0.3444	0.3293	0.3481	0.3333	0.3518	0.3374	0.3554
B13		B23		B33		B43	
CIE X	CIE Y	CIE X	CIE Y	CIE X	CIE Y	CIE X	CIE Y
0.3215	0.3353	0.3254	0.3388	0.3293	0.3423	0.3332	0.3458
0.3218	0.3298	0.3256	0.3331	0.3294	0.3364	0.3331	0.3398
0.3256	0.3331	0.3294	0.3364	0.3331	0.3398	0.3369	0.3431
0.3254	0.3388	0.3293	0.3423	0.3332	0.3458	0.3371	0.3493
B14		B24		B34		B44	
CIE X	CIE Y	CIE X	CIE Y	CIE X	CIE Y	CIE X	CIE Y
0.3218	0.3298	0.3256	0.3331	0.3294	0.3364	0.3331	0.3398
0.3222	0.3243	0.3258	0.3275	0.3294	0.3306	0.3330	0.3338
0.3258	0.3275	0.3294	0.3306	0.3330	0.3338	0.3366	0.3369
0.3256	0.3331	0.3294	0.3364	0.3331	0.3398	0.3369	0.3431

## Color Bin Structure

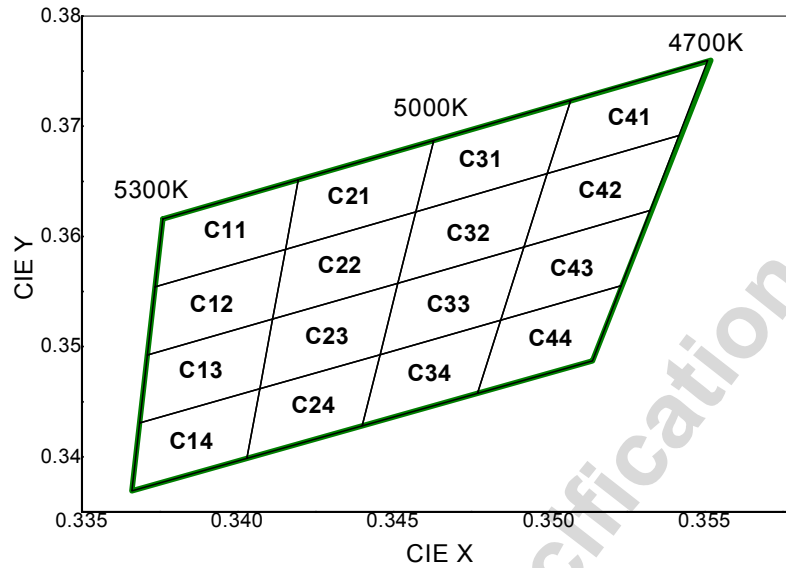
 $\langle I_F = 100\text{mA}, T_a = 25^\circ\text{C} \rangle$ 

C11		C21		C31		C41	
CIE X	CIE Y	CIE X	CIE Y	CIE X	CIE Y	CIE X	CIE Y
0.3376	0.3616	0.3420	0.3652	0.3463	0.3687	0.3507	0.3724
0.3374	0.3554	0.3415	0.3588	0.3457	0.3622	0.3500	0.3657
0.3415	0.3588	0.3457	0.3622	0.3500	0.3657	0.3542	0.3692
0.3420	0.3652	0.3463	0.3687	0.3507	0.3724	0.3551	0.3760
C12		C22		C32		C42	
CIE X	CIE Y	CIE X	CIE Y	CIE X	CIE Y	CIE X	CIE Y
0.3374	0.3554	0.3415	0.3588	0.3457	0.3622	0.3500	0.3657
0.3371	0.3493	0.3411	0.3525	0.3452	0.3558	0.3492	0.3591
0.3411	0.3525	0.3452	0.3558	0.3492	0.3591	0.3533	0.3624
0.3415	0.3588	0.3457	0.3622	0.3500	0.3657	0.3542	0.3692
C13		C23		C33		C43	
CIE X	CIE Y	CIE X	CIE Y	CIE X	CIE Y	CIE X	CIE Y
0.3371	0.3493	0.3411	0.3525	0.3452	0.3558	0.3492	0.3591
0.3369	0.3431	0.3407	0.3462	0.3446	0.3493	0.3485	0.3524
0.3407	0.3462	0.3446	0.3493	0.3485	0.3524	0.3523	0.3555
0.3411	0.3525	0.3452	0.3558	0.3492	0.3591	0.3533	0.3624
C14		C24		C34		C44	
CIE X	CIE Y	CIE X	CIE Y	CIE X	CIE Y	CIE X	CIE Y
0.3369	0.3431	0.3407	0.3462	0.3446	0.3493	0.3485	0.3524
0.3366	0.3369	0.3403	0.3399	0.3440	0.3428	0.3477	0.3458
0.3403	0.3399	0.3440	0.3428	0.3477	0.3458	0.3514	0.3487
0.3407	0.3462	0.3446	0.3493	0.3485	0.3524	0.3523	0.3555

## Color Bin Structure

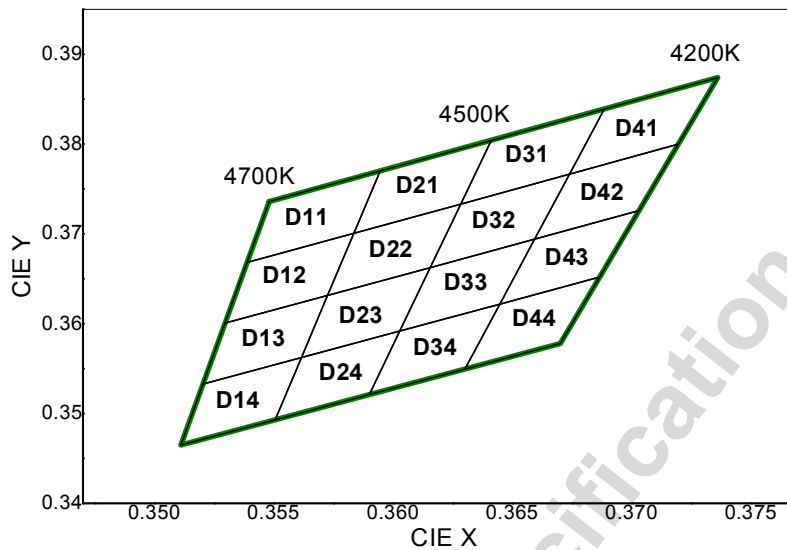
 $\langle I_F = 100\text{mA}, T_a = 25^\circ\text{C} \rangle$ 

D11		D21		D31		D41	
CIE X	CIE Y	CIE X	CIE Y	CIE X	CIE Y	CIE X	CIE Y
0.3548	0.3736	0.3595	0.3770	0.3641	0.3804	0.3689	0.3839
0.3539	0.3668	0.3584	0.3701	0.3628	0.3733	0.3674	0.3767
0.3584	0.3701	0.3628	0.3733	0.3674	0.3767	0.3720	0.3800
0.3595	0.3770	0.3641	0.3804	0.3689	0.3839	0.3736	0.3874
D12		D22		D32		D42	
CIE X	CIE Y	CIE X	CIE Y	CIE X	CIE Y	CIE X	CIE Y
0.3539	0.3668	0.3584	0.3701	0.3628	0.3733	0.3674	0.3767
0.3530	0.3601	0.3573	0.3632	0.3616	0.3663	0.3659	0.3694
0.3573	0.3632	0.3616	0.3663	0.3659	0.3694	0.3703	0.3726
0.3584	0.3701	0.3628	0.3733	0.3674	0.3767	0.3720	0.3800
D13		D23		D33		D43	
CIE X	CIE Y	CIE X	CIE Y	CIE X	CIE Y	CIE X	CIE Y
0.3530	0.3601	0.3573	0.3632	0.3616	0.3663	0.3659	0.3694
0.3520	0.3533	0.3562	0.3562	0.3603	0.3592	0.3645	0.3622
0.3562	0.3562	0.3603	0.3592	0.3645	0.3622	0.3687	0.3652
0.3573	0.3632	0.3616	0.3663	0.3659	0.3694	0.3703	0.3726
D14		D24		D34		D44	
CIE X	CIE Y	CIE X	CIE Y	CIE X	CIE Y	CIE X	CIE Y
0.3520	0.3533	0.3562	0.3562	0.3603	0.3592	0.3645	0.3622
0.3511	0.3465	0.3551	0.3493	0.3590	0.3521	0.3630	0.3550
0.3551	0.3493	0.3590	0.3521	0.3630	0.3550	0.3670	0.3578
0.3562	0.3562	0.3603	0.3592	0.3645	0.3622	0.3687	0.3652

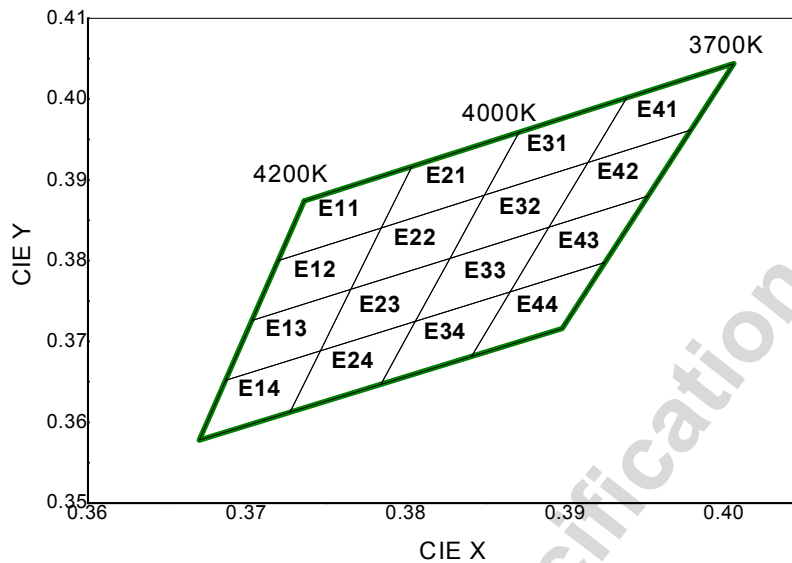

## Color Bin Structure

 $\langle I_F = 100\text{mA}, T_a = 25^\circ\text{C} \rangle$ 

E11		E21		E31		E41	
CIE X	CIE Y	CIE X	CIE Y	CIE X	CIE Y	CIE X	CIE Y
0.3736	0.3874	0.3804	0.3917	0.3871	0.3959	0.3939	0.4002
0.3720	0.3800	0.3784	0.3841	0.3849	0.3881	0.3914	0.3922
0.3784	0.3841	0.3849	0.3881	0.3914	0.3922	0.3979	0.3962
0.3804	0.3917	0.3871	0.3959	0.3939	0.4002	0.4006	0.4044
E12		E22		E32		E42	
CIE X	CIE Y	CIE X	CIE Y	CIE X	CIE Y	CIE X	CIE Y
0.3720	0.3800	0.3784	0.3841	0.3849	0.3881	0.3914	0.3922
0.3703	0.3726	0.3765	0.3765	0.3828	0.3803	0.3890	0.3842
0.3765	0.3765	0.3828	0.3803	0.3890	0.3842	0.3952	0.3880
0.3784	0.3841	0.3849	0.3881	0.3914	0.3922	0.3979	0.3962
E13		E23		E33		E43	
CIE X	CIE Y	CIE X	CIE Y	CIE X	CIE Y	CIE X	CIE Y
0.3703	0.3726	0.3765	0.3765	0.3828	0.3803	0.3890	0.3842
0.3687	0.3652	0.3746	0.3689	0.3806	0.3725	0.3865	0.3762
0.3746	0.3689	0.3806	0.3725	0.3865	0.3762	0.3925	0.3798
0.3765	0.3765	0.3828	0.3803	0.3890	0.3842	0.3952	0.3880
E14		E24		E34		E44	
CIE X	CIE Y	CIE X	CIE Y	CIE X	CIE Y	CIE X	CIE Y
0.3687	0.3652	0.3746	0.3689	0.3806	0.3725	0.3865	0.3762
0.3670	0.3578	0.3727	0.3613	0.3784	0.3647	0.3841	0.3682
0.3727	0.3613	0.3784	0.3647	0.3841	0.3682	0.3898	0.3716
0.3746	0.3689	0.3806	0.3725	0.3865	0.3762	0.3925	0.3798



## Part List

Table 4. Part List Table

No	Part	Silk	Specification	Q'ty
1	LED	-	STW8C2SA	8
2	Lens	-	PC	8
3	FR-4 PCB	-	500mm X 15mm, 1.0T	1

Preliminary Specification

## Marking Information



[Attach point]

\* PCB label SPEC'

- resolution : 300dpi
- QR code Cell size : > 0.25mm
- QR code details

SCLF08111
131029
000001B

①
②
③

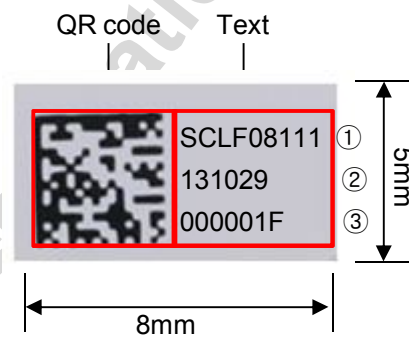
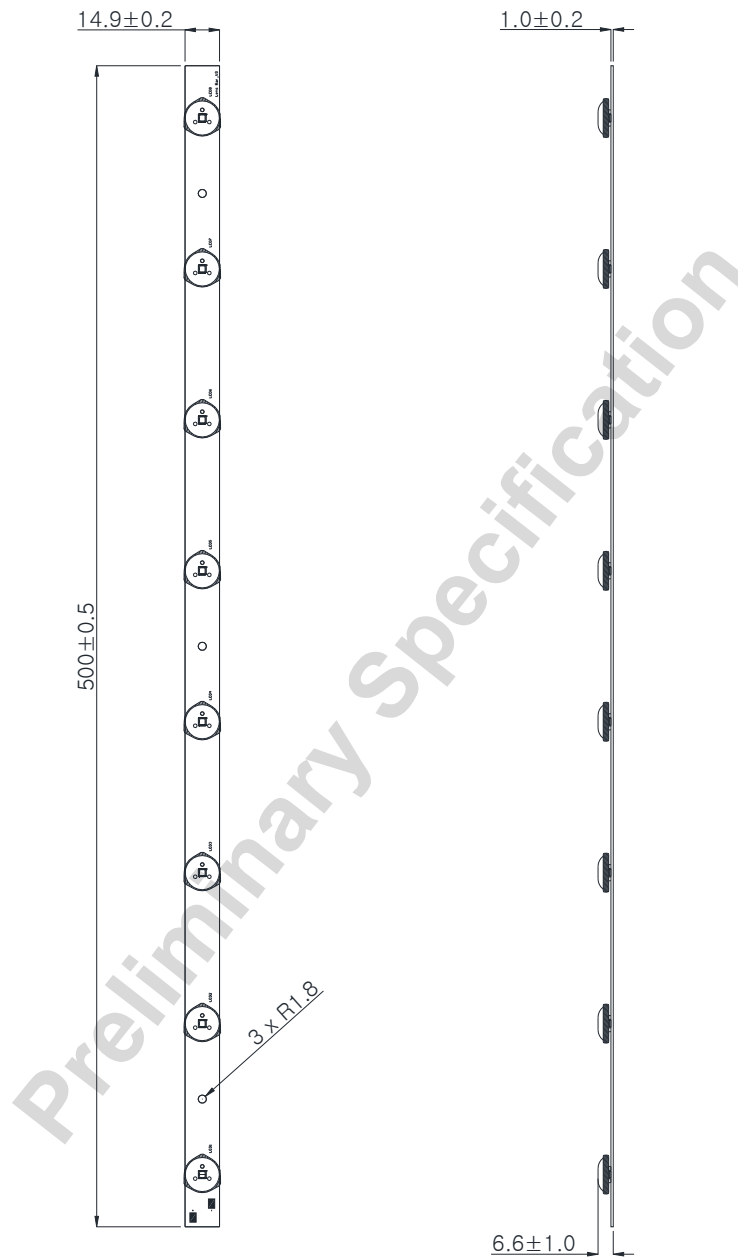

**Table 5. QR code SPEC'**

No.	Data	Digit	Remark
①	Manufacturer	2	SC
	Product Name.	4	LF08
	PKG rank number	3	111
②	SMT day code (YYMMDD)	6	131029
③	Serial number	6	000001 ~ 999999
	CCT number	1	A~E

**Table 6. LED Rank & CCT Rank Table**

Intensity	No	CIE	No	CIE	No	V <sub>F</sub>	No.	CCT	No.
K21	1	*11	1	*31	A	Z58	1	6,500K	A
K24	2	*12	2	*32	B	Z60	2	5,600K	B
K27	3	*13	3	*33	C	Z62	3	5,000K	C
		*14	4	*34	D			4,500K	D
		*21	5	*41	E			4,000K	E
		*22	6	*42	F				
		*23	7	*43	G				
		*24	8	*44	H				

## Mechanical Dimensions



**Notes :**

1. All dimensions are in millimeters.
2. Scale : none

### Circuit Drawing

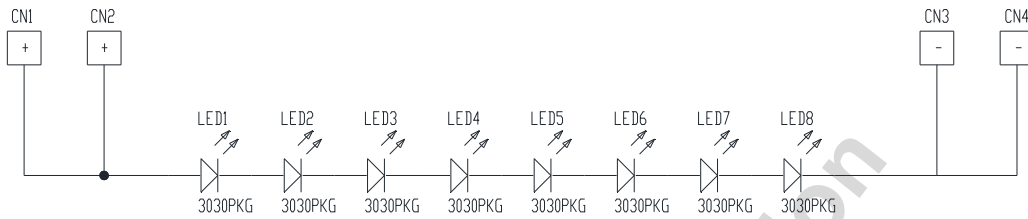

Preliminary Specification

## Packing

**Table 7. Tray & Box information**

TRAY		BOX	
SIZE	Q'TY	OUTER SIZE	Q'TY
735 x 375 x 13 (mm)	10bars	810 X 380 X 220 (mm)	20(21) Trays

\* Tray material : Anti-static PET

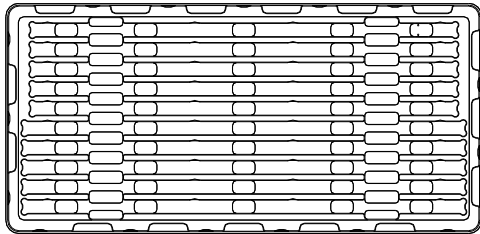

1 Tray = 10bars(MAX)

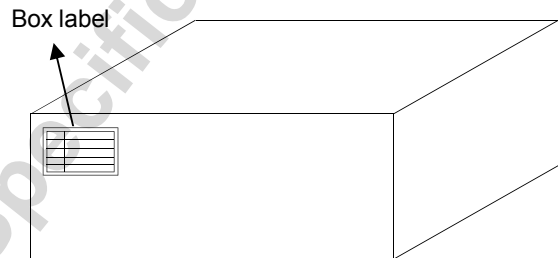

\* Box label must be put on the front side of the box that is readable when loaded on a pallet.

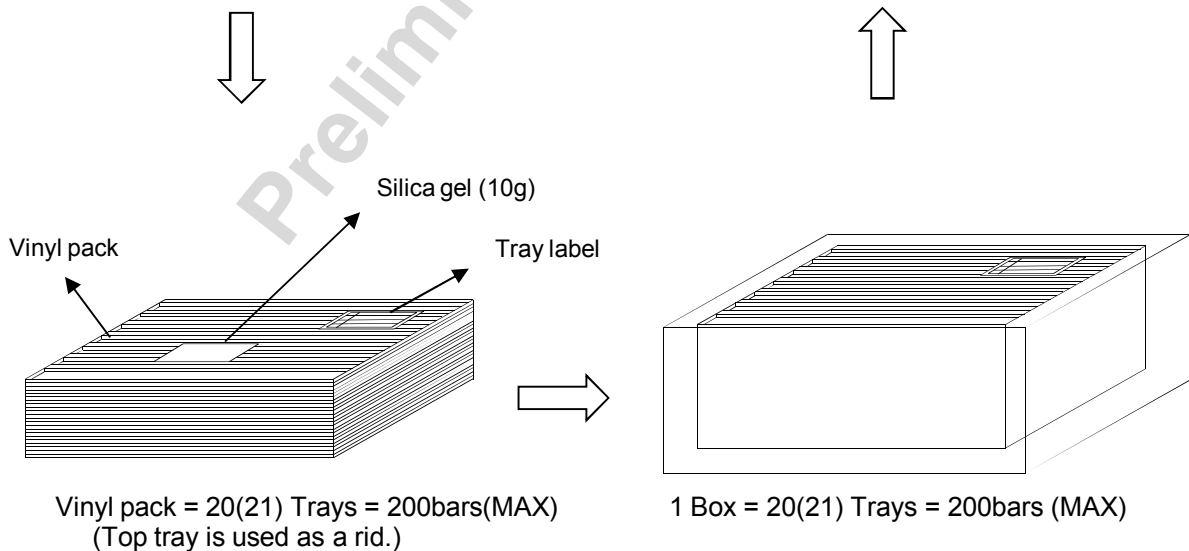

## Packing

### < Remainder Packing >

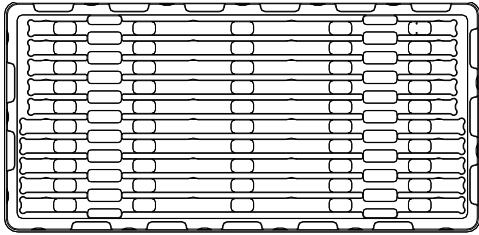

(One tray is made up same PKG rank.)

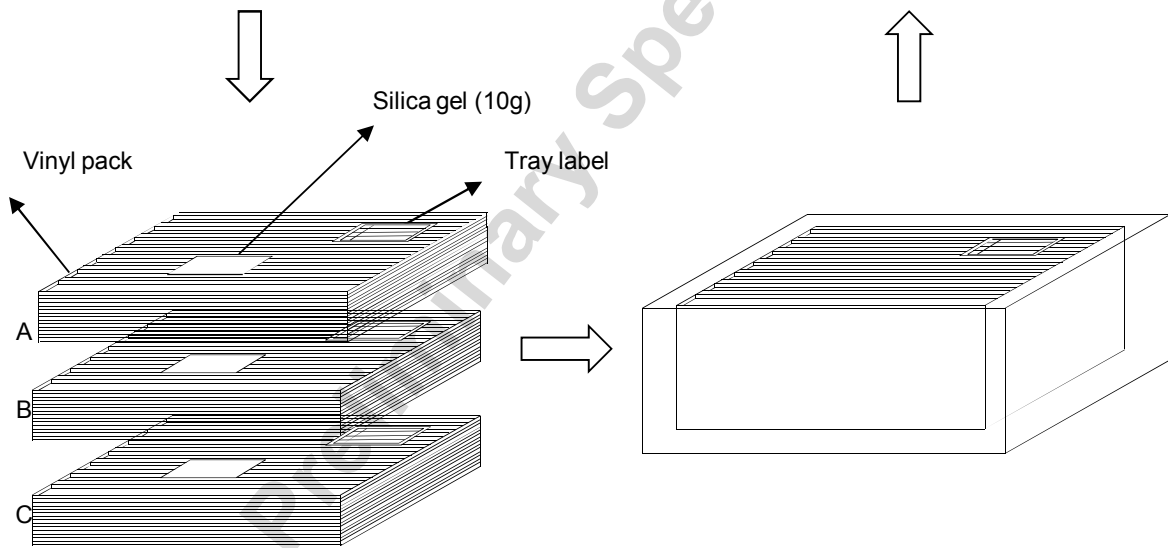
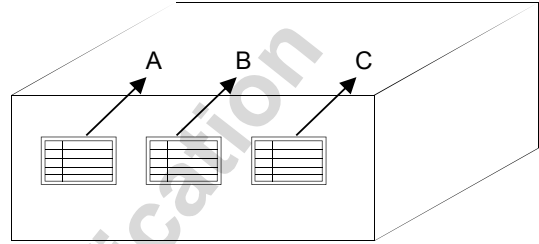





\* Each vinyl pack is composed of the same PKG rank.  
 (Top tray is used as a rid in vinyl.)

※ If the box is empty space, paper pads are supplied to fill the empty space.



## Label Information





### 1. Tray label

<b>Model No.</b>	 <b>SMJF-LF08X00-XX</b>
<b>Rank</b>	 <b>K24F22Z60</b>
<b>Type</b>	<b>Lens Linear Module</b>
<b>Quantity</b>	 <b>XX</b>
<b>Date</b>	 <b>YYYY.MM.DD</b>
	<b>SEOUL SEMICONDUCTOR CO.,LTD.</b>

Size : 10cm \* 7cm

Position : On the top side of tray

### 2. BOX label

<b>Model No.</b>	 <b>SMJF-LF08X00-XX</b>
<b>Rank</b>	 <b>K24F22Z60</b>
<b>Type</b>	<b>Lens Linear Module</b>
<b>Quantity</b>	 <b>XX</b>
<b>Date</b>	 <b>YYYY.MM.DD</b>
	<b>SEOUL SEMICONDUCTOR CO.,LTD.</b>

Size : 10cm \* 10cm

Position : On the front side of box

## Precaution for Use

1. DO NOT touch any of the circuit board, components or terminals with body or metal while circuit is active.
2. Long time exposure to sunlight or UV can cause the lens to discolor.
3. Please do not use adhesives to attach the LED that outgas organic vapor.
4. Please do not use together with the materials containing Sulfur.
5. Please do not assemble in conditions of high moisture and/or oxidizing gas such as Cl, H<sub>2</sub>S, NH<sub>3</sub>, SO<sub>2</sub>, NOX, etc.
6. Please do not make any modification on module.
7. Please be cautious when soldering to board so as not to create a short between different trace patterns.

## Handling of Silicone Resin for LEDs

1. Please do not touch the silicone resin area with sharp objects such as pincette(tweezers).
2. Finger prints on silicone resin area may affect the performance.
3. Please store LEDs in covered containers to prevent dust accumulation as this may affect performance.
4. Excessive force more than 3000gf to the silicone lens can result in fatal or permanent damage with LEDs.
5. Please do not cover the silicone resin area with any other resins such as epoxy, urethane, etc.



## Storage before use

1. Do not impact or place pressure on this product because even a small amount of pressure can damage the product. The product should also not be placed in high temperatures, high humidity or direct sunlight since the device is sensitive to these conditions.
2. When storing devices for a long period of time before usage, please following
3. these guidelines:
  - \* The devices should be stored in the anti-static bag that it was shipped in from Seoul-Semiconductor with opening.
  - \* If the anti-static bag has been opened, re-seal preventing air and moisture from being present in the bag.

Preliminary Specification



## Company Information

### Published by

Seoul Semiconductor © 2013 All Rights Reserved.

### Company Information

Seoul Semiconductor (SeoulSemicon.com) manufactures and packages a wide selection of light emitting diodes (LEDs) for the automotive, general illumination/lighting, appliance, signage and back lighting markets. The company is the world's fifth largest LED supplier, holding more than 10,000 patents globally, while offering a wide range of LED technology and production capacity in areas such as "nPola", deep UV LEDs, "Acrich", the world's first commercially produced AC LED, and "Acrich MJT - Multi-Junction Technology" a proprietary family of high-voltage LEDs. The company's broad product portfolio includes a wide array of package and device choices such as Acrich, high-brightness LEDs, mid-power LEDs, side-view LEDs, through-hole type LED lamps, custom displays, and sensors. The company is vertically integrated from epitaxial growth and chip manufacture in its fully owned subsidiary, Seoul Viosys, through packaged LEDs and LED modules in three Seoul Semiconductor manufacturing facilities. Seoul Viosys also manufactures a wide range of unique deep-UV wavelength devices.

### Legal Disclaimer

Information in this document is provided in connection with Seoul Semiconductor products. With respect to any examples or hints given herein, any typical values stated herein and/or any information regarding the application of the device, Seoul Semiconductor hereby disclaims any and all warranties and liabilities of any kind, including without limitation, warranties of non-infringement of intellectual property rights of any third party. The appearance and specifications of the product can be changed to improve the quality and/or performance without notice.