



Chipsmall Limited consists of a professional team with an average of over 10 year of expertise in the distribution of electronic components. Based in Hongkong, we have already established firm and mutual-benefit business relationships with customers from,Europe,America and south Asia,supplying obsolete and hard-to-find components to meet their specific needs.

With the principle of “Quality Parts,Customers Priority,Honest Operation,and Considerate Service”,our business mainly focus on the distribution of electronic components. Line cards we deal with include Microchip,ALPS,ROHM,Xilinx,Pulse,ON,Everlight and Freescale. Main products comprise IC,Modules,Potentiometer,IC Socket,Relay,Connector.Our parts cover such applications as commercial,industrial, and automotives areas.

We are looking forward to setting up business relationship with you and hope to provide you with the best service and solution. Let us make a better world for our industry!



Contact us

Tel: +86-755-8981 8866 Fax: +86-755-8427 6832

Email & Skype: info@chipsmall.com Web: www.chipsmall.com

Address: A1208, Overseas Decoration Building, #122 Zhenhua RD., Futian, Shenzhen, China



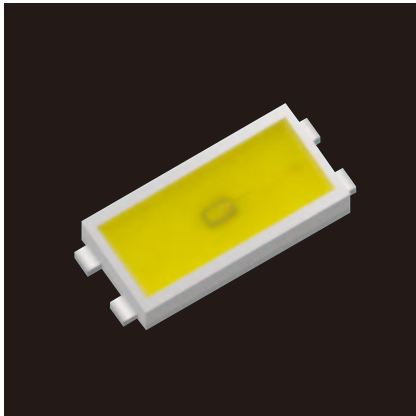

SMLK34 series

PSML2

4520 (1808)
4.5 × 2.0mm (t=0.6mm)

Specifications

- High heat radiation package from ROHM original flat frame structure.
- Warm white, True white.

Color Type WB

Specifications

Part No.	Chip Structure	Emitting Color	Absolute Maximum Ratings (Ta=25°C)					Electrical and Optical Characteristics (Ta=25°C)									
			Power Dissipation Pd (mW)	Forward Current IF (mA)	Peak Forward Current I _{FP} (mA)	Reverse Voltage VR (V)	Operating Temperature Topr (°C)	Storage Temperature Tstg (°C)	Forward Voltage VF Typ. (V)	IF (mA)	Chromaticity Coordinates (x, y)	IF (mA)	Luminous Intensity I _v Min. (mcd)	Typ. (mcd)	Luminous Flux Φ _v Typ. (lm)	IF (mA)	
<input type="checkbox"/> SMLK34WBECW	InGaN	White	360	90	300*	-	-40 to +100	-40 to +100	3.4	60	(0.30, 0.28)	60	4000	5500	60	(14)	60
<input type="checkbox"/> SMLK34WBEDW											(0.34, 0.34)						
<input type="checkbox"/> SMLK34WBEAW		High color rendering index (5000K)									(0.345, 0.351)	2200	3800	(9.5)			
<input type="checkbox"/> SMLK34WBEBW		High color rendering index (3000K)									(0.44, 0.40)						

* Duty1/10 1kHz (): Reference

Dimensions

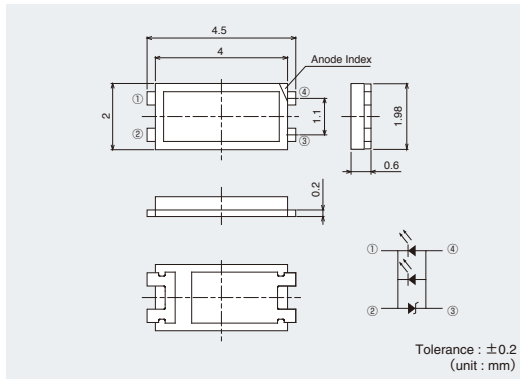

Recommended Solder Pattern

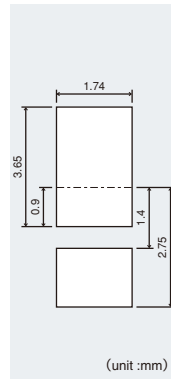

Viewing Angle

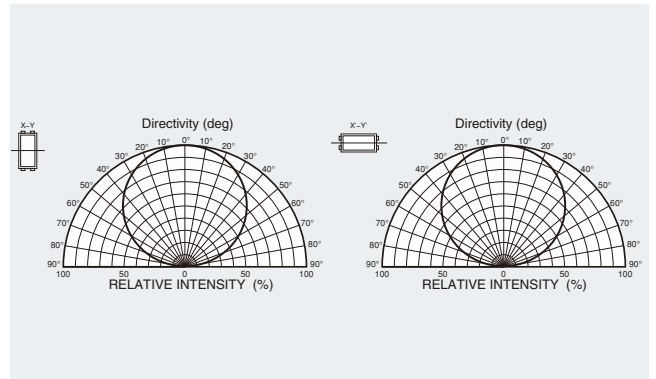

Chromaticity Diagram

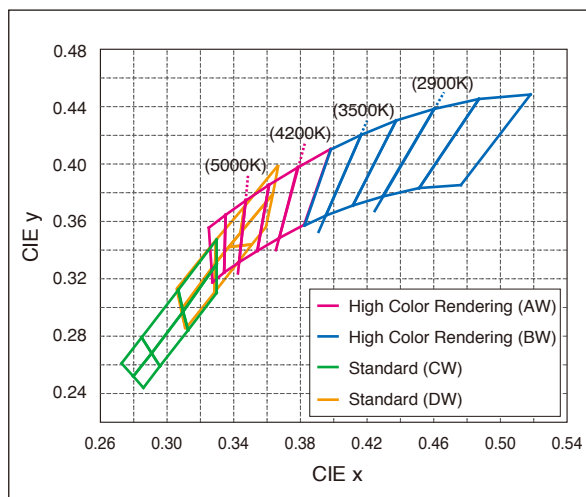

IV-θv

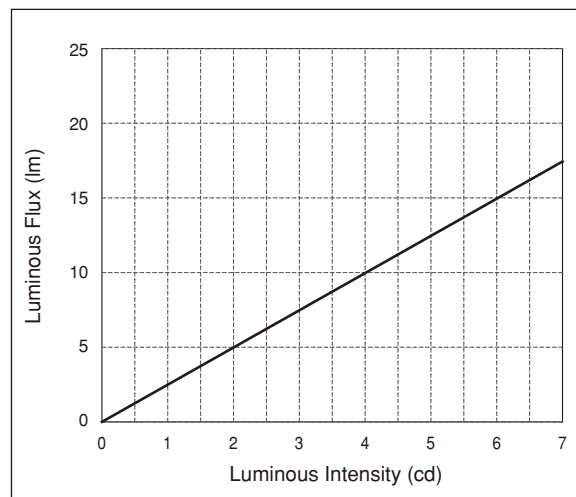

Electrical Characteristics Curves

Forward Current-Forward Voltage

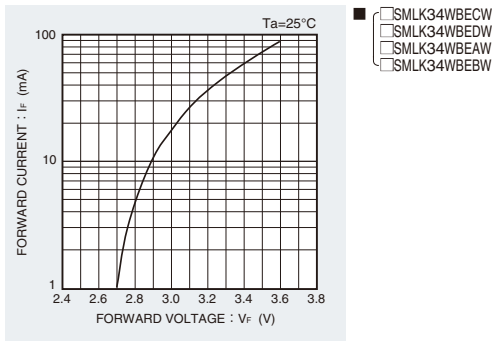

- SMLK34WBECW
- SMLK34WBEDW
- SMLK34WBEAW
- SMLK34WBEBW

Luminous Intensity-Atmosphere Temperature

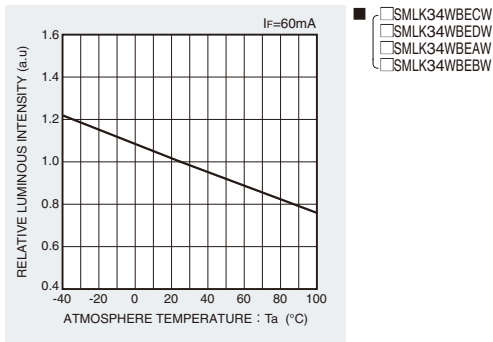

- SMLK34WBECW
- SMLK34WBEDW
- SMLK34WBEAW
- SMLK34WBEBW

Luminous Intensity-Forward Current

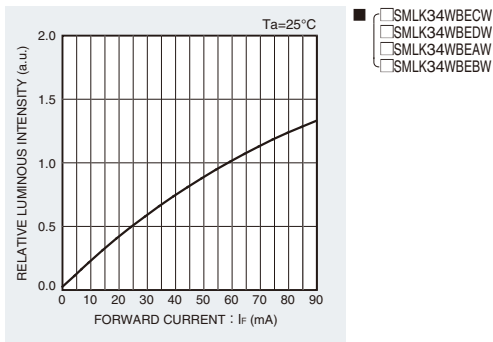

- SMLK34WBECW
- SMLK34WBEDW
- SMLK34WBEAW
- SMLK34WBEBW

Derating

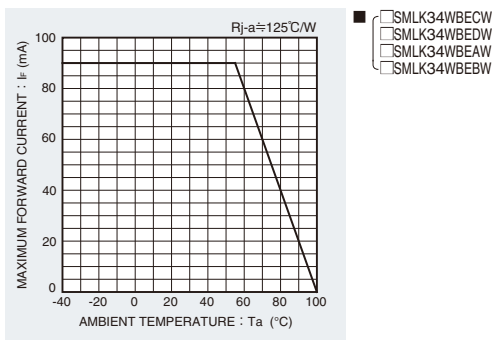

- SMLK34WBECW
- SMLK34WBEDW
- SMLK34WBEAW
- SMLK34WBEBW

Rank Reference of Brightness

White (WB)

(Ta=25°C, If=60mA)

Package size (mm)	Height (mm)	Luminous intensity (mcd)	C	D	E	F	G	H	
			2200 to 2700	2700 to 3300	3300 to 4000	4000 to 4800	4800 to 5800	5800 to 7000	
PSML2	4520	0.6	SMLK34WBEAW						
			SMLK34WBEBW						
			SMLK34WBECW						
			SMLK34WBEDW						

Part No. Construction

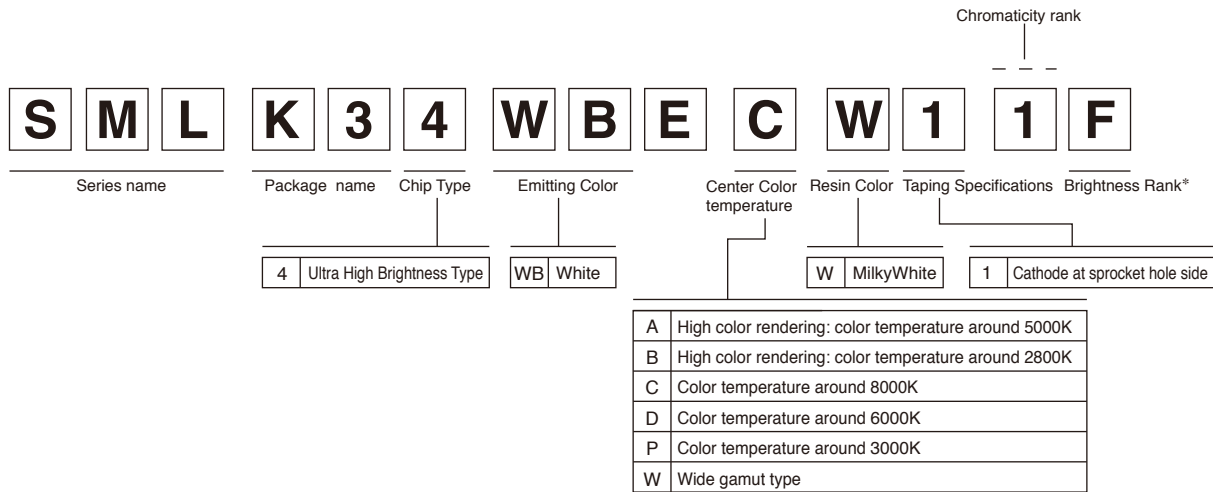

- * Concerning the Brightness rank
- Please refer to the rank chart above for luminous intensity classification.
- Part name is individual for each rank.
- When shipped as sample, the part name will be a representative part name.
- General products are free of ranks. Please contact sales if rank appointment is needed.

Packing Specification

ROHM LED products are being shipped with desiccant (silica gel) concluded in moisture-proof bags. Pasting the moisture sensitive label on the outer surface of the moisture-proof bags or enclosing the humidity indication card inside the bag is available upon request. Please contact the nearest sales office or distributor if necessary.

Notes

No copying or reproduction of this document, in part or in whole, is permitted without the consent of ROHM Co.,Ltd.

The content specified herein is subject to change for improvement without notice.

The content specified herein is for the purpose of introducing ROHM's products (hereinafter "Products"). If you wish to use any such Product, please be sure to refer to the specifications, which can be obtained from ROHM upon request.

Examples of application circuits, circuit constants and any other information contained herein illustrate the standard usage and operations of the Products. The peripheral conditions must be taken into account when designing circuits for mass production.

Great care was taken in ensuring the accuracy of the information specified in this document. However, should you incur any damage arising from any inaccuracy or misprint of such information, ROHM shall bear no responsibility for such damage.

The technical information specified herein is intended only to show the typical functions of and examples of application circuits for the Products. ROHM does not grant you, explicitly or implicitly, any license to use or exercise intellectual property or other rights held by ROHM and other parties. ROHM shall bear no responsibility whatsoever for any dispute arising from the use of such technical information.

The Products specified in this document are intended to be used with general-use electronic equipment or devices (such as audio visual equipment, office-automation equipment, communication devices, electronic appliances and amusement devices).

The Products specified in this document are not designed to be radiation tolerant.

While ROHM always makes efforts to enhance the quality and reliability of its Products, a Product may fail or malfunction for a variety of reasons.

Please be sure to implement in your equipment using the Products safety measures to guard against the possibility of physical injury, fire or any other damage caused in the event of the failure of any Product, such as derating, redundancy, fire control and fail-safe designs. ROHM shall bear no responsibility whatsoever for your use of any Product outside of the prescribed scope or not in accordance with the instruction manual.

The Products are not designed or manufactured to be used with any equipment, device or system which requires an extremely high level of reliability the failure or malfunction of which may result in a direct threat to human life or create a risk of human injury (such as a medical instrument, transportation equipment, aerospace machinery, nuclear-reactor controller, fuel-controller or other safety device). ROHM shall bear no responsibility in any way for use of any of the Products for the above special purposes. If a Product is intended to be used for any such special purpose, please contact a ROHM sales representative before purchasing.

If you intend to export or ship overseas any Product or technology specified herein that may be controlled under the Foreign Exchange and the Foreign Trade Law, you will be required to obtain a license or permit under the Law.



Thank you for your accessing to ROHM product informations.
More detail product informations and catalogs are available, please contact us.

ROHM Customer Support System

<http://www.rohm.com/contact/>