



Chipsmall Limited consists of a professional team with an average of over 10 year of expertise in the distribution of electronic components. Based in Hongkong, we have already established firm and mutual-benefit business relationships with customers from,Europe,America and south Asia,supplying obsolete and hard-to-find components to meet their specific needs.

With the principle of "Quality Parts,Customers Priority,Honest Operation,and Considerate Service",our business mainly focus on the distribution of electronic components. Line cards we deal with include Microchip,ALPS,ROHM,Xilinx,Pulse,ON,Everlight and Freescale. Main products comprise IC,Modules,Potentiometer,IC Socket,Relay,Connector.Our parts cover such applications as commercial,industrial, and automotives areas.

We are looking forward to setting up business relationship with you and hope to provide you with the best service and solution. Let us make a better world for our industry!



## Contact us

Tel: +86-755-8981 8866 Fax: +86-755-8427 6832

Email & Skype: info@chipsmall.com Web: www.chipsmall.com

Address: A1208, Overseas Decoration Building, #122 Zhenhua RD., Futian, Shenzhen, China



# MMBFJ309L, MMBFJ310L, SMMBFJ309L, SMMBFJ310L

## JFET - VHF/UHF Amplifier Transistor

### N-Channel

#### Features

- Drain and Source are Interchangeable
- S Prefix for Automotive and Other Applications Requiring Unique Site and Control Change Requirements; AEC-Q101 Qualified and PPAP Capable
- These Devices are Pb-Free, Halogen Free/BFR Free and are RoHS Compliant

#### MAXIMUM RATINGS

Rating	Symbol	Value	Unit
Drain-Source Voltage	$V_{DS}$	25	Vdc
Gate-Source Voltage	$V_{GS}$	25	Vdc
Gate Current	$I_G$	10	mAdc

#### THERMAL CHARACTERISTICS

Characteristic	Symbol	Max	Unit
Total Device Dissipation FR-5 Board, (Note 1) $T_A = 25^\circ\text{C}$ Derate above $25^\circ\text{C}$	$P_D$	225 1.8	mW mW/ $^\circ\text{C}$
Thermal Resistance, Junction-to-Ambient	$R_{\theta JA}$	556	$^\circ\text{C}/\text{W}$
Junction and Storage Temperature	$T_J, T_{stg}$	-55 to +150	$^\circ\text{C}$

Stresses exceeding those listed in the Maximum Ratings table may damage the device. If any of these limits are exceeded, device functionality should not be assumed, damage may occur and reliability may be affected.

1. FR-5 = 1.0 x 0.75 x 0.062 in.



ON Semiconductor®

[www.onsemi.com](http://www.onsemi.com)

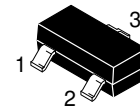
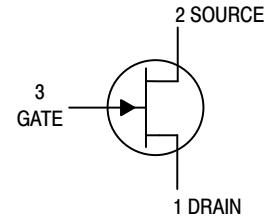

SOT-23 (TO-236)  
CASE 318  
STYLE 10

#### MARKING DIAGRAM

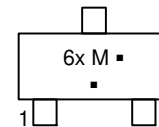

6x = Device Code  
 x = U for MMBFJ309L, SMMBFJ309L  
 x = T for MMBFJ310L, SMMBFJ310L  
 M = Date Code\*  
 ▪ = Pb-Free Package

(Note: Microdot may be in either location)  
 \*Date Code orientation and/or overbar may vary depending upon manufacturing location.

#### ORDERING INFORMATION

Device	Package	Shipping†
MMBFJ309LT1G, SMMBFJ309LT1G	SOT-23 (Pb-Free)	3,000 / Tape & Reel
MMBFJ310LT1G, SMMBFJ310LT1G	SOT-23 (Pb-Free)	3,000 / Tape & Reel
SMMBFJ310LT3G	SOT-23 (Pb-Free)	10,000 / Tape & Reel

†For information on tape and reel specifications, including part orientation and tape sizes, please refer to our Tape and Reel Packaging Specifications Brochure, BRD8011/D.

# MMBFJ309L, MMBFJ310L, SMMBFJ309L, SMMBFJ310L

## ELECTRICAL CHARACTERISTICS ( $T_A = 25^\circ\text{C}$ unless otherwise noted)

Characteristic	Symbol	Min	Typ	Max	Unit
<b>OFF CHARACTERISTICS</b>					
Gate–Source Breakdown Voltage ( $I_G = -1.0 \mu\text{Adc}$ , $V_{DS} = 0$ )	$V_{(BR)GSS}$	-25	-	-	Vdc
Gate Reverse Current ( $V_{GS} = -15 \text{ Vdc}$ ) ( $V_{GS} = -15 \text{ Vdc}$ , $T_A = 125^\circ\text{C}$ )	$I_{GSS}$	-	-	-1.0 -1.0	nAdc $\mu\text{Adc}$
Gate Source Cutoff Voltage ( $V_{DS} = 10 \text{ Vdc}$ , $I_D = 1.0 \text{ nAdc}$ )	$V_{GS(off)}$	-1.0 -2.0	- -	-4.0 -6.5	Vdc
					MMBFJ309 MMBFJ310, SMMBFJ310
<b>ON CHARACTERISTICS</b>					
Zero–Gate–Voltage Drain Current ( $V_{DS} = 10 \text{ Vdc}$ , $V_{GS} = 0$ )	$I_{DSS}$	12 24	- -	30 60	mAdc
					MMBFJ309 MMBFJ310, SMMBFJ310
Gate–Source Forward Voltage ( $I_G = 1.0 \text{ mAdc}$ , $V_{DS} = 0$ )	$V_{GS(f)}$	-	-	1.0	Vdc
<b>SMALL–SIGNAL CHARACTERISTICS</b>					
Forward Transfer Admittance ( $V_{DS} = 10 \text{ Vdc}$ , $I_D = 10 \text{ mAdc}$ , $f = 1.0 \text{ kHz}$ )	$ Y_{fs} $	8.0	-	18	mmhos
Output Admittance ( $V_{DS} = 10 \text{ Vdc}$ , $I_D = 10 \text{ mAdc}$ , $f = 1.0 \text{ kHz}$ )	$ y_{os} $	-	-	250	$\mu\text{mhos}$
Input Capacitance ( $V_{GS} = -10 \text{ Vdc}$ , $V_{DS} = 0 \text{ Vdc}$ , $f = 1.0 \text{ MHz}$ )	$C_{iss}$	-	-	5.0	pF
Reverse Transfer Capacitance ( $V_{GS} = -10 \text{ Vdc}$ , $V_{DS} = 0 \text{ Vdc}$ , $f = 1.0 \text{ MHz}$ )	$C_{rss}$	-	-	2.5	pF
Equivalent Short–Circuit Input Noise Voltage ( $V_{DS} = 10 \text{ Vdc}$ , $I_D = 10 \text{ mAdc}$ , $f = 100 \text{ Hz}$ )	$\bar{e}_n$	-	10	-	$\text{nV}/\sqrt{\text{Hz}}$

Product parametric performance is indicated in the Electrical Characteristics for the listed test conditions, unless otherwise noted. Product performance may not be indicated by the Electrical Characteristics if operated under different conditions.

MMBFJ309L, MMBFJ310L, SMMBFJ309L, SMMBFJ310L

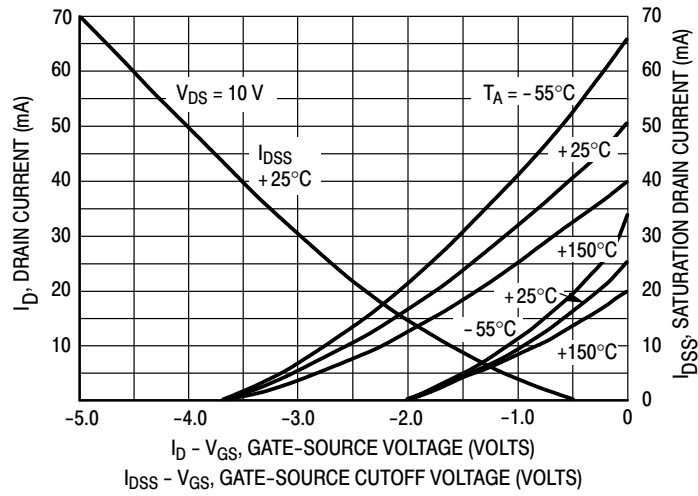

Figure 1. Drain Current and Transfer Characteristics versus Gate-Source Voltage

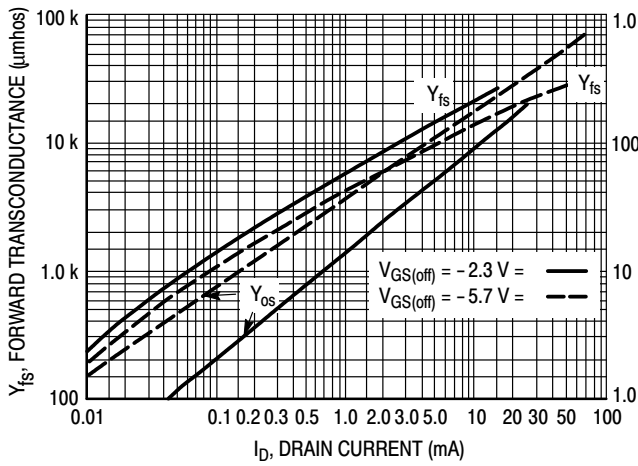

Figure 2. Common-Source Output Admittance and Forward Transconductance versus Drain Current

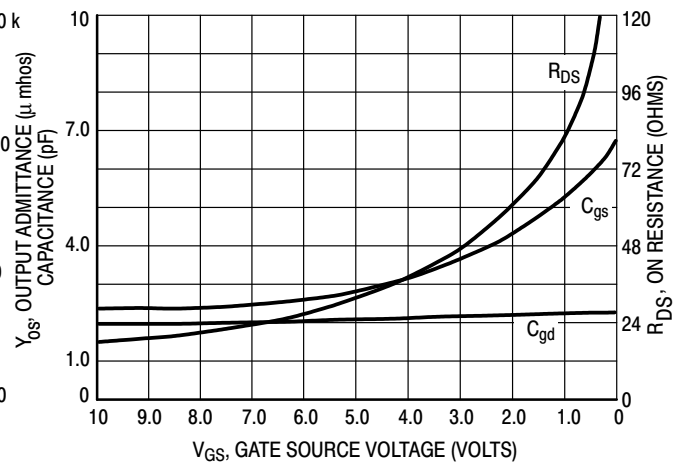

Figure 3. On Resistance and Junction Capacitance versus Gate-Source Voltage

MMBFJ309L, MMBFJ310L, SMMBFJ309L, SMMBFJ310L

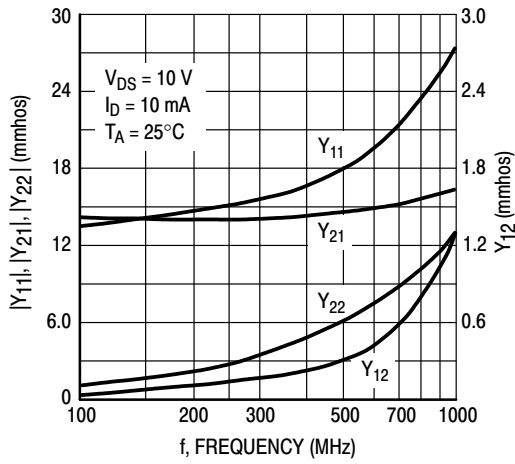

Figure 4. Common-Gate Y Parameter Magnitude versus Frequency

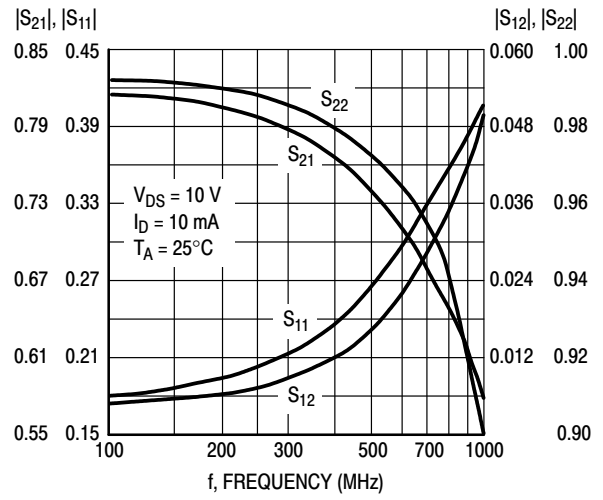

Figure 5. Common-Gate S Parameter Magnitude versus Frequency

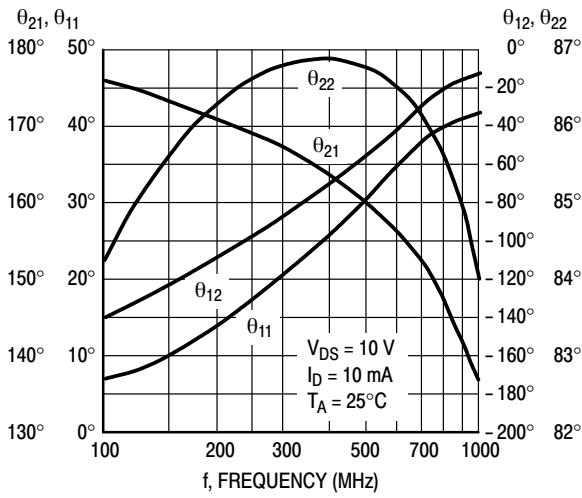

Figure 6. Common-Gate Y Parameter Phase-Angle versus Frequency

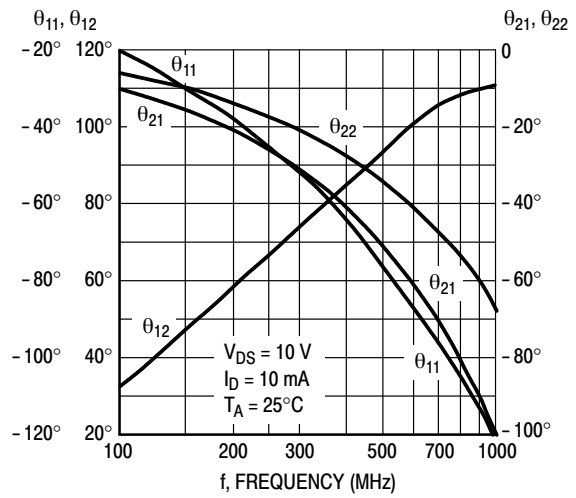
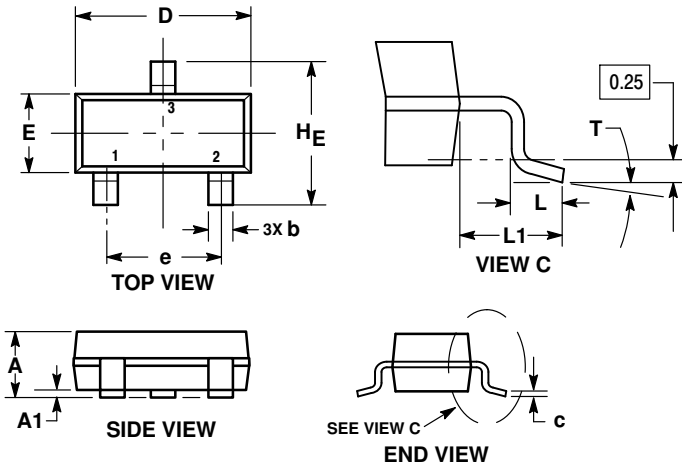

Figure 7. S Parameter Phase-Angle versus Frequency

# MMBFJ309L, MMBFJ310L, SMMBFJ309L, SMMBFJ310L

## PACKAGE DIMENSIONS

SOT-23 (TO-236)  
CASE 318-08  
ISSUE AR



NOTES:

1. DIMENSIONING AND TOLERANCING PER ASME Y14.5M, 1994.
2. CONTROLLING DIMENSION: MILLIMETERS.
3. MAXIMUM LEAD THICKNESS INCLUDES LEAD FINISH. MINIMUM LEAD THICKNESS IS THE MINIMUM THICKNESS OF THE BASE MATERIAL.
4. DIMENSIONS D AND E DO NOT INCLUDE MOLD FLASH, PROTRUSIONS, OR GATE BURRS.

DIM	MILLIMETERS			INCHES		
	MIN	NOM	MAX	MIN	NOM	MAX
A	0.89	1.00	1.11	0.035	0.039	0.044
A1	0.01	0.06	0.10	0.000	0.002	0.004
b	0.37	0.44	0.50	0.015	0.017	0.020
c	0.08	0.14	0.20	0.003	0.006	0.008
D	2.80	2.90	3.04	0.110	0.114	0.120
E	1.20	1.30	1.40	0.047	0.051	0.055
e	1.78	1.90	2.04	0.070	0.075	0.080
L	0.30	0.43	0.55	0.012	0.017	0.022
L1	0.35	0.54	0.69	0.014	0.021	0.027
HE	2.10	2.40	2.64	0.083	0.094	0.104
T	0°	---	10°	0°	---	10°

STYLE 10:  
PIN 1. DRAIN  
2. SOURCE  
3. GATE

### RECOMMENDED SOLDERING FOOTPRINT\*

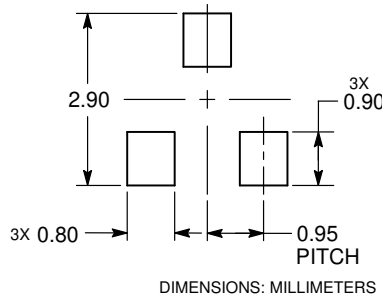

\*For additional information on our Pb-Free strategy and soldering details, please download the ON Semiconductor Soldering and Mounting Techniques Reference Manual, SOLDERRM/D.

ON Semiconductor and are trademarks of Semiconductor Components Industries, LLC dba ON Semiconductor or its subsidiaries in the United States and/or other countries. ON Semiconductor owns the rights to a number of patents, trademarks, copyrights, trade secrets, and other intellectual property. A listing of ON Semiconductor's product/patent coverage may be accessed at [www.onsemi.com/site/pdf/Patent-Marketing.pdf](http://www.onsemi.com/site/pdf/Patent-Marketing.pdf). ON Semiconductor reserves the right to make changes without further notice to any products herein. ON Semiconductor makes no warranty, representation or guarantee regarding the suitability of its products for any particular purpose, nor does ON Semiconductor assume any liability arising out of the application or use of any product or circuit, and specifically disclaims any and all liability, including without limitation special, consequential or incidental damages. Buyer is responsible for its products and applications using ON Semiconductor products, including compliance with all laws, regulations and safety requirements or standards, regardless of any support or applications information provided by ON Semiconductor. "Typical" parameters which may be provided in ON Semiconductor data sheets and/or specifications can and do vary in different applications and actual performance may vary over time. All operating parameters, including "Typicals" must be validated for each customer application by customer's technical experts. ON Semiconductor does not convey any license under its patent rights nor the rights of others. ON Semiconductor products are not designed, intended, or authorized for use as a critical component in life support systems or any FDA Class 3 medical devices or medical devices with a same or similar classification in a foreign jurisdiction or any devices intended for implantation in the human body. Should Buyer purchase or use ON Semiconductor products for any such unintended or unauthorized application, Buyer shall indemnify and hold ON Semiconductor and its officers, employees, subsidiaries, affiliates, and distributors harmless against all claims, costs, damages, and expenses, and reasonable attorney fees arising out of, directly or indirectly, any claim of personal injury or death associated with such unintended or unauthorized use, even if such claim alleges that ON Semiconductor was negligent regarding the design or manufacture of the part. ON Semiconductor is an Equal Opportunity/Affirmative Action Employer. This literature is subject to all applicable copyright laws and is not for resale in any manner.

### PUBLICATION ORDERING INFORMATION

**LITERATURE FULFILLMENT:**  
Literature Distribution Center for ON Semiconductor  
19521 E. 32nd Pkwy, Aurora, Colorado 80011 USA  
**Phone:** 303-675-2175 or 800-344-3860 Toll Free USA/Canada  
**Fax:** 303-675-2176 or 800-344-3867 Toll Free USA/Canada  
**Email:** [orderlit@onsemi.com](mailto:orderlit@onsemi.com)

**N. American Technical Support:** 800-282-9855 Toll Free  
USA/Canada  
**Europe, Middle East and Africa Technical Support:**  
Phone: 421 33 790 2910  
**Japan Customer Focus Center**  
Phone: 81-3-5817-1050

**ON Semiconductor Website:** [www.onsemi.com](http://www.onsemi.com)  
**Order Literature:** <http://www.onsemi.com/orderlit>

For additional information, please contact your local Sales Representative