



Chipsmall Limited consists of a professional team with an average of over 10 year of expertise in the distribution of electronic components. Based in Hongkong, we have already established firm and mutual-benefit business relationships with customers from,Europe,America and south Asia,supplying obsolete and hard-to-find components to meet their specific needs.

With the principle of “Quality Parts,Customers Priority,Honest Operation,and Considerate Service”,our business mainly focus on the distribution of electronic components. Line cards we deal with include Microchip,ALPS,ROHM,Xilinx,Pulse,ON,Everlight and Freescale. Main products comprise IC,Modules,Potentiometer,IC Socket,Relay,Connector.Our parts cover such applications as commercial,industrial, and automotives areas.

We are looking forward to setting up business relationship with you and hope to provide you with the best service and solution. Let us make a better world for our industry!



Contact us

Tel: +86-755-8981 8866 Fax: +86-755-8427 6832

Email & Skype: info@chipsmall.com Web: www.chipsmall.com

Address: A1208, Overseas Decoration Building, #122 Zhenhua RD., Futian, Shenzhen, China



DESIGNED & DIMENSIONED
IN MILLIMETERS [INCHES]

DO NOT
SCALE FROM
THIS PRINT

ITEM	COMPONENT	-HG	-GF
1	SHELL	SMP-PX-P-G-ST-TH2-SHL (SEE TABLE 2)	SMP-PX-P-F-ST-TH2-SHL (SEE TABLE 2)
2	PIN	SMP-P-P-H-ST-TH2-PIN	SMP-P-P-G-ST-TH2-PIN
3	INSULATOR	SMP-P-P-ST-TH2-INS	

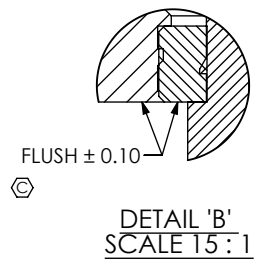
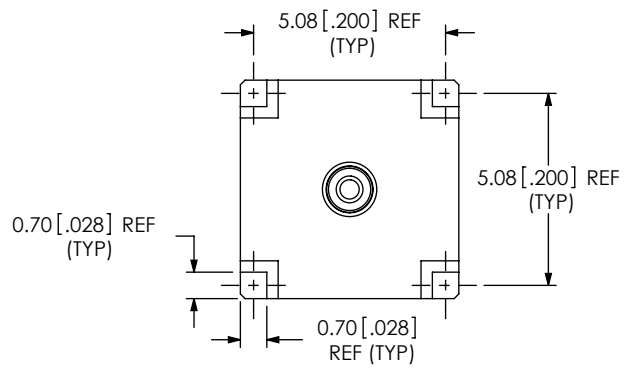
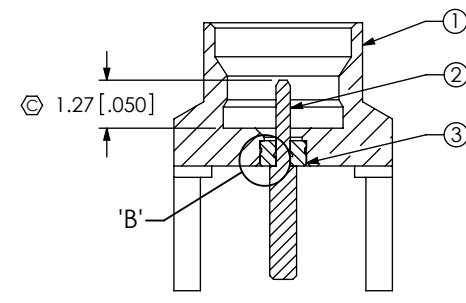
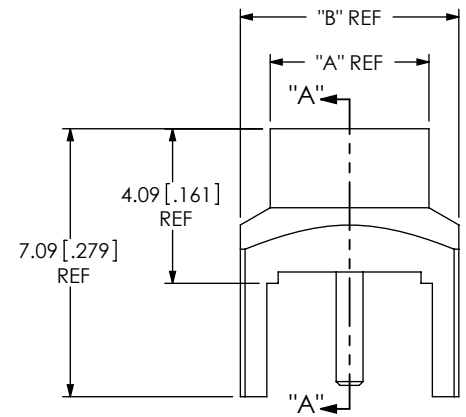

SMP-PX-P-XX-ST-TH2

GENDER
-P: PLUG

TERMINATION
-TH2: THROUGH HOLE
(.200" PITCH)

ORIENTATION
-ST: STRAIGHT

PLATING SPECIFICATION
-HG: 30µ" GOLD CENTER CONTACT,
10µ" GOLD OUTER CONTACT
-GF: 10µ" GOLD CENTER CONTACT,
3µ" GOLD OUTER CONTACT
(SEE TABLE 1)

INTERFACE
-F: FULL DETENT
-L: LIMITED DETENT
-S: SMOOTH BORE
-C: CATCHER'S MITT

TYPE
-P: PCB

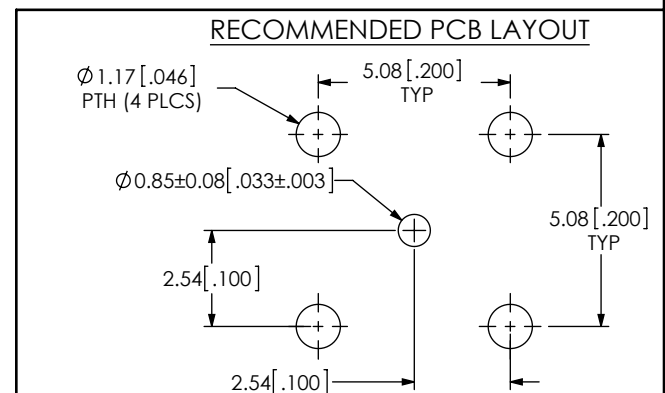
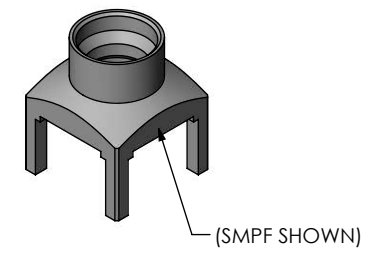
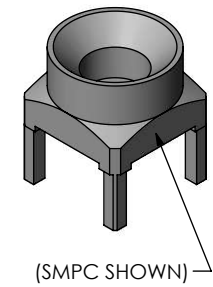

INTERFACE	SMP-PX-P-X-ST-TH1-SHL	"A"	"B"
-F	SMP-PF-P-X-ST-TH2-SHL	Ø4.20 [.165]	□5.78 [.228]
-L	SMP-PL-P-X-ST-TH2-SHL	Ø4.20 [.165]	□5.78 [.228]
-S	SMP-PS-P-X-ST-TH2-SHL	Ø4.20 [.165]	□5.78 [.228]
-C	SMP-PC-P-X-ST-TH2-SHL	Ø5.99 [.236]	□5.99 [.236]

- NOTES:
- ⊕ REPRESENTS A CRITICAL DIMENSION.
 - MINIMUM PUSHOUT FORCE FOR CENTER CONTACT: 4.45N [1.0 LB].
INSULATOR: 6.67N [1.5 LB].
 - PRODUCT TO BE PACKAGED PER PACKING STANDARD CO-RF-WI-3040-M.
TRAY: TY-SMA001-1
COVER: TY-SMA001-2
200 PARTS PER TRAY (2 PARTS PER POCKET)

<p>UNLESS OTHERWISE SPECIFIED, DIMENSIONS ARE IN MILLIMETERS. TOLERANCES ARE:</p> <p>DECIMALS ANGLES</p> <p>X.X: ±0.3 [.01] 5°</p> <p>X.XX: ±0.13 [.005]</p> <p>X.XXX: ±0.051 [.0020]</p>	<p>PROPRIETARY NOTE</p> <p>THIS DOCUMENT CONTAINS INFORMATION CONFIDENTIAL AND PROPRIETARY TO SAMTEC, INC. AND SHALL NOT BE REPRODUCED OR TRANSFERRED TO OTHER DOCUMENTS OR DISCLOSED TO OTHERS OR USED FOR ANY PURPOSE OTHER THAN THAT WHICH IT WAS OBTAINED WITHOUT THE EXPRESSED WRITTEN CONSENT OF SAMTEC, INC.</p>	<p>520 PARK EAST BLVD, NEW ALBANY, IN 47150 PHONE: 812-944-6733 FAX: 812-948-5047 e-Mail: info@SAMTEC.com code 55322</p>
<p>F:\DWG\MISC\MKTG\SMP-PX-P-XX-ST-TH2-MKT.SLDDRW</p>		<p>BY: T MEEK 10/29/2010 SHEET 1 OF 1</p>