



Chipsmall Limited consists of a professional team with an average of over 10 year of expertise in the distribution of electronic components. Based in Hongkong, we have already established firm and mutual-benefit business relationships with customers from,Europe,America and south Asia,supplying obsolete and hard-to-find components to meet their specific needs.

With the principle of “Quality Parts,Customers Priority,Honest Operation,and Considerate Service”,our business mainly focus on the distribution of electronic components. Line cards we deal with include Microchip,ALPS,ROHM,Xilinx,Pulse,ON,Everlight and Freescale. Main products comprise IC,Modules,Potentiometer,IC Socket,Relay,Connector.Our parts cover such applications as commercial,industrial, and automotives areas.

We are looking forward to setting up business relationship with you and hope to provide you with the best service and solution. Let us make a better world for our industry!



Contact us

Tel: +86-755-8981 8866 Fax: +86-755-8427 6832

Email & Skype: info@chipsmall.com Web: www.chipsmall.com

Address: A1208, Overseas Decoration Building, #122 Zhenhua RD., Futian, Shenzhen, China



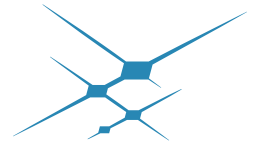

SKYWORKS®

BREAKTHROUGH SIMPLICITY®

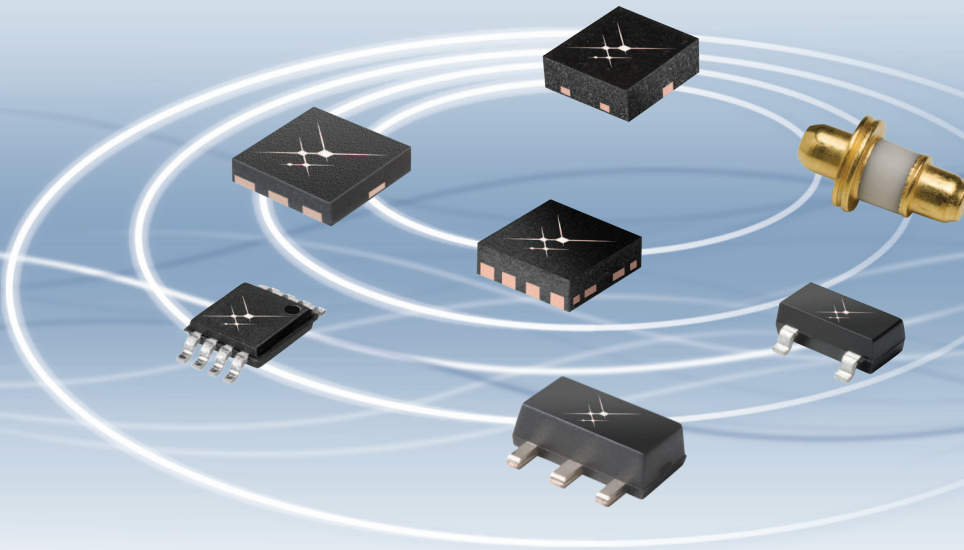

Wireless Infrastructure Solutions

Skyworks Solutions

Skyworks Solutions, Inc. is an innovator of high reliability analog and mixed signal semiconductors. Leveraging core technologies, Skyworks offers diverse standard and custom linear products supporting automotive, broadband, cellular infrastructure, energy management, industrial, medical, military and mobile handset applications. The Company's portfolio includes amplifiers, attenuators, detectors, diodes, directional couplers, front-end modules, hybrids, infrastructure RF subsystems, mixers/demodulators, phase shifters, PLLs/synthesizers/VCOs, power dividers/combiners, receivers, switches and technical ceramics.

Headquartered in Woburn, Massachusetts, USA, Skyworks is worldwide with engineering, manufacturing, sales and service facilities throughout Asia, Europe and North America.

New products are continually being introduced at Skyworks. For the latest information, visit our Web site at www.skyworksinc.com. For additional information, please contact your local sales office or email us at sales@skyworksinc.com.

The Skyworks Advantage

- Broad front-end module and precision analog product portfolio
- Market leadership in key product segments
- Solutions for all air interface standards, including CDMA2000, GSM/GPRS/EDGE, LTE, WCDMA and WLAN
- Engagements with a diverse set of top-tier customers
- Analog, RF and mixed signal design capabilities
- Access to all key process technologies: GaAs HBT, PHEMT, BiCMOS, SiGe, CMOS, RF CMOS and Silicon
- World-class manufacturing capabilities and scale
- Unparalleled level of customer service and technical support
- Commitment to technology innovation

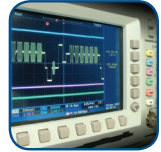

Table of Contents

Discrete to Highly Integrated Solutions	4
Block Diagrams	
Simplified Infrastructure Transceiver	5
2G, 3G Base Station Repeater	5
Product Specifications	
RF Switching	6
Receiver Protection	10
Low Noise Amplifiers	11
Gain Control Attenuation	12
Gain Blocks and Power Amplifiers	13
Mixers	15
Discrete	17
Hybrid Couplers	18
Directional Couplers	18
Power Detectors	19
Modulators/Demodulators	19
VCOs/Synthesizers	20
Power Dividers/Combiners	21
Phase Shifters	22
Skyworks Sales Offices	23

Wireless Infrastructure Solutions

Skyworks Solutions offers a broad portfolio of RF/microwave products for wireless communications infrastructure systems, including cellular telephone base stations, WiMAX access points, land-mobile radio systems, point-to-point radio links and more. Our portfolio is comprised of components and subsystems from the antenna connection to the baseband output, including low noise amplifiers, power amplifiers, general-purpose amplifiers, mixers, modulators, demodulators, phase shifters, switches, attenuators, detectors, directional couplers, hybrid couplers, power splitters/combiners, ceramic filters and resonators, as well as discrete control components such as PIN diodes, tuning varactor diodes, Schottky diodes, chip attenuators and more.

New products are continually being introduced at Skyworks. For the latest information, visit our Web site at www.skyworksinc.com. For additional information, please contact your local sales office or email us at sales@skyworksinc.com.



Innovation to Go™

Select products and sample/designer kits available for purchase online. www.skyworksinc.com



Skyworks lead (Pb)-free products are compliant to all applicable materials legislation. For additional information, refer to *Skyworks Definition of Lead (Pb)-Free*, document number SQ04-0073. Tin/lead (SnPb) packaging is not recommended for new designs.



Skyworks Green™ products are compliant to all applicable materials legislation and are halogen-free. For additional information, refer to *Skyworks Definition of Green™*, document number SQ04-0074.



Skyworks Solutions, Inc.

20 Sylvan Road, Woburn, MA 01801
USA: (781) 376-3000 • Asia: 886 2 2735 0399
Europe: 33 (0)1 41443660 • Fax: (781) 376-3100
Email: sales@skyworksinc.com • www.skyworksinc.com

BRO390-10A 9/10

Discrete to Highly Integrated Solutions



Discrete

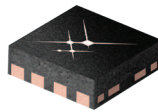
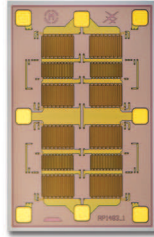

MMIC

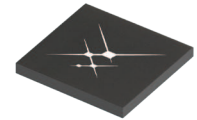
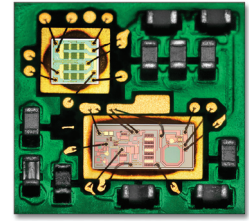

MCM

Skyworks Solutions is uniquely qualified to provide the level of integration that matches the needs of our customers' design goals. Our broad portfolio includes solutions from discrete diode and transistor devices to Microwave Monolithic Integrated Circuit (MMIC) designs. Using these discrete and MMICs, we are able to offer Multichip Module (MCM) products fully encapsulated on a laminate substrate. These MCMs contain all necessary bias and matching circuits to offer a drop-in component count for integrated solutions. MCMs are offered for many wireless infrastructure applications in amplifiers, mixers and modulation/demodulation.

Discrete and Integrated Solutions for Your Wireless Infrastructure Application Designs

Applications	Gain Block Amplifiers	Low Noise Amplifier	Attenuator	Detector	Diode	Hybrid Coupler	Mixer	Modulators/ Demodulators	Switch	Transistor	VCO / Synthesizer
LTE cellular telephone base station	•	•	•	•	•	•	•	•	•	•	•
WiMAX access point	•	•	•	•	•	•	•	•	•	•	•
Land-mobile radio system	•	•	•	•	•	•	•	•	•	•	•
Point-to-point radio link	•	•	•	•	•	•	•	•	•	•	•

 Skyworks Green™ products are compliant to all applicable materials legislation and are halogen-free. For additional information, refer to *Skyworks Definition of Green™*, document number SQ04-0074.

Simplified Infrastructure Transceiver Block Diagram

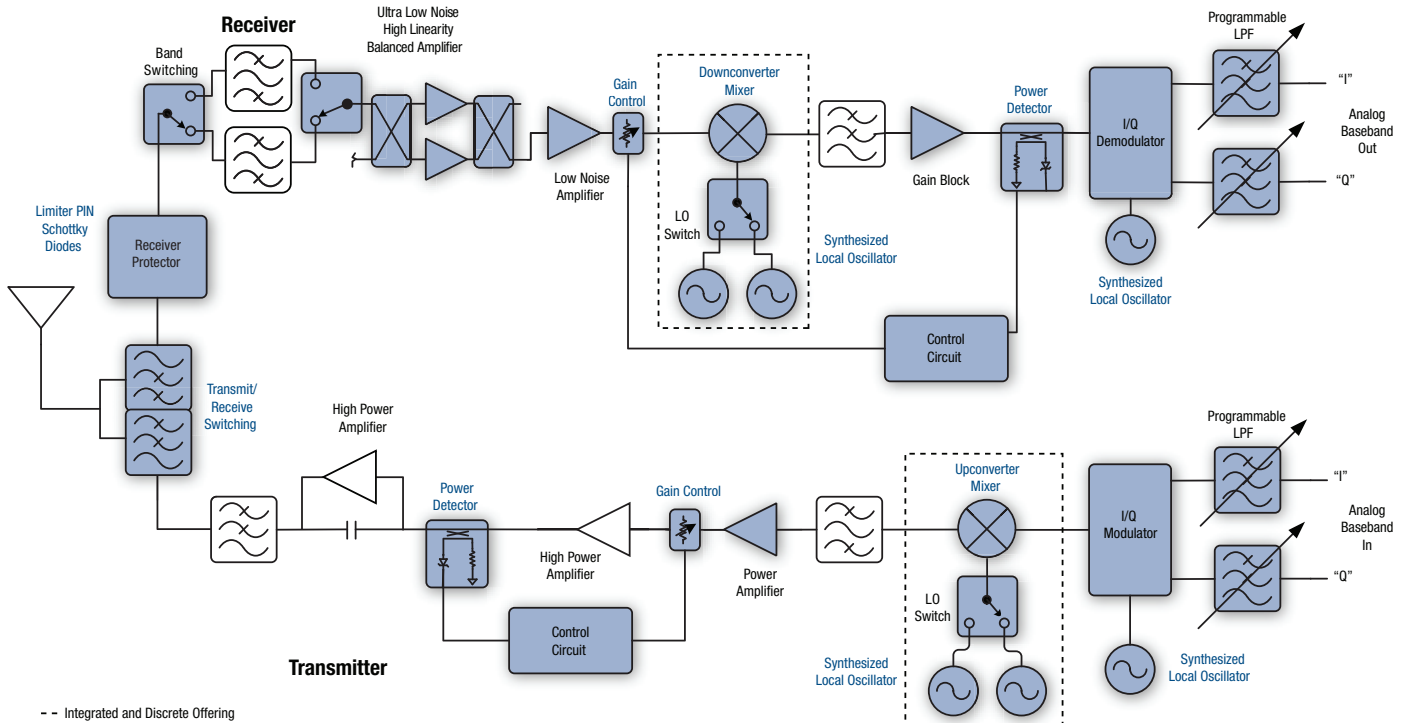

2G, 3G Base Station Repeater Block Diagram

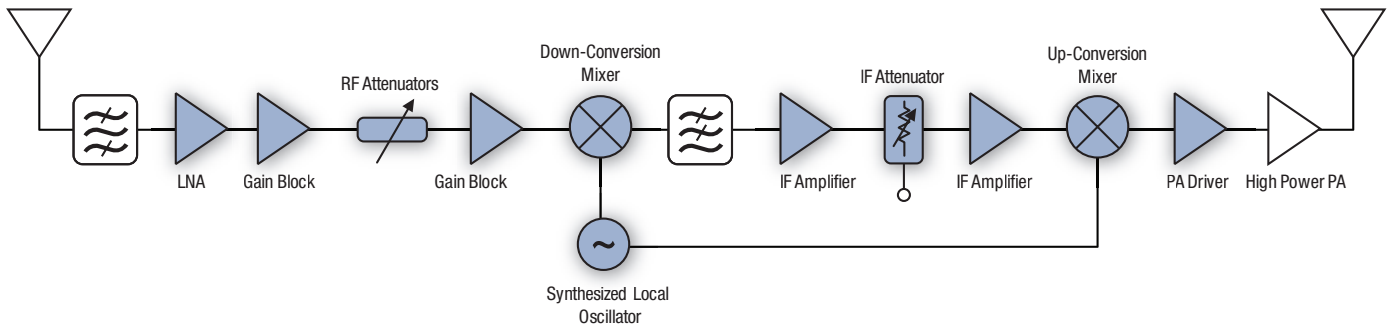

Skyworks' broad product portfolio includes components and subsystems from the antenna connection to the baseband output, as well as discrete control components:

Components and Subsystems

- Low noise amplifiers
- Power amplifiers
- General-purpose amplifiers (gain blocks)
- Mixers
- Modulators
- Demodulators
- Switches
- Attenuators
- Detectors
- Directional couplers
- Hybrid couplers
- Power splitters/combiners
- Ceramic filters
- Resonators
- Phase shifters

Discrete Control Components

- PIN diodes
- Tuning varactor diodes
- Schottky diodes
- Chip attenuators

For complete product specifications and our latest product offering, please visit our Web site at www.skyworksinc.com.

RF Switching

Skyworks offers both MMIC and discrete solutions for transmit/receive antenna switching applications. A transmit/receive switch directs either the received signal to the receiver or the transmit signal from the transmitter. Additionally switches are used in filter bank switching and synthesized local oscillator mixer applications. Key performance specifications include high power handling, insertion loss, isolation and linearity. Please refer to the following product listing.

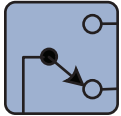

MMIC

SPST and SPDT RF Switches



Part Number	Description (Absorptive/ Reflective)	Frequency (GHz)	Typ. IL (dB)	Typ. Isol. (dB)	Typ. IIP3 (dBm)	Typ. IP _{1dB} (dBm)	Package (mm)
SKY13299-321LF	SPDT (R)	0.02–5.0	0.3–0.75	30–22	57	38.5 @ 0.1 dB	QFN-12 3 x 3 x 0.75
SKY13319-374LF	SPDT (R)	0.1–3.0	0.35–0.60	25–17	60	36 @ 0.1 dB	DFN-6 1.5 x 1.5 x 0.41
SKY13320-374LF	SPDT (R)	0.1–6.0	0.4–0.6	28–24	52	33 @ 0.1 dB	DFN-6 1.5 x 1.5 x 0.41
SKY13321-360LF	SPDT (R)	0.1–3.0	0.4–0.6	26–16	62	39 @ 0.1 dB	DFN-8 2 x 2 x 0.9
SKY13347-360LF	SPST (A)	0.5–3.0	0.6–0.8	45–30	40	27	DFN-8 2 x 2 x 0.9
AS179-92LF	SPDT (R)	0.02–3.0	0.3–0.4	25–23	48	30	SC-88 2.1 x 2 x 0.95
SKY13270-92LF	SPDT (R)	0.1–2.5	0.3–0.55	30–17	56	37 @ 0.1 dB	SC-88 2.1 x 2 x 0.95
SKY13286-359LF	SPDT (A)	0.1–6.0	0.8–1.50	62–42	46	30	QFN-16 4 x 4 x 0.9
SKY13290-313LF	SPDT (R)	0.02–2.5	0.4–0.55	26–18	63	40.5 @ 0.1 dB	DFN-6 2 x 3 x 0.7
SKY13306-313LF	SPDT (R)	0.1–6.0	0.4–0.55	26–18	53	35 @ 0.1 dB	DFN-6 2 x 3 x 0.7
SKY13323-378LF	SPDT (R)	0.1–3.0	0.2–0.50	27–24	37	27	DFN-6 1 x 1 x 0.5
SKY13335-381LF	SPDT (R)	0.1–6.0	0.20–0.60	24–27	37–48	15–29	DFN-6 1.5 x 2 x 0.41
SKY13350-385LF	SPDT (R)	0.8–6.0	0.35–0.60	18–20	50	33	DFN-6 1 x 1 x 0.45
SKY13348-374LF	SPDT (A)	0.5–6.0	0.60–1.00	29–21	60	37	DFN-6 1.5 x 1.5 x 0.41

SP3T RF Switches

Part Number	Description (Absorptive/ Reflective)	Frequency (GHz)	Typ. IL (dB)	Typ. Isol. (dB)	Typ. IIP3 (dBm)	Typ. IP _{1dB} (dBm)	Package (mm)
SKY13251-349LF	SP3T (R)	LF–3.0	0.35–0.6	29–15	46	25	DFN-8 2 x 2 x 0.7
SKY13277-355LF	SP3T (A)	0.5–2.5	0.9–1.2	62–55	43	30	QFN-20 5 x 5 x 0.9
SKY13309-370LF	SP3T (R)	0.1–3.0	0.5–0.6	26–25	45	29	DFN-8 2 x 2 x 0.6
SKY13317-373LF	SP3T (R)	0.02–6.0	0.2–0.8	40–22	50	29	DFN-8 1.5 x 1.5 x 0.45
SKY13346-368LF	SP3T (R)	0.5–2.5	0.4–0.5	25–28	47	30	QFN-12 2 x 2 x 0.55

RF Switching (continued)





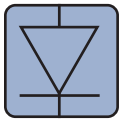

SP4T RF Switches

Part Number	Description (Absorptive/ Reflective)	Frequency (GHz)	Typ. IL (dB)	Typ. Isol. (dB)	Typ. IIP3 (dBm)	Typ. IP _{1dB} (dBm)	Package (mm)
SKY13296-340LF	SP4T (A)	0.02–2.5	0.4–0.7	40–26	40	18	QFN-20 4 x 4 x 0.75
 SKY13322-375LF	SP4T (R)	0.02–6.0	0.5–1.3	50–24	47	30	QFN-10 2 x 3 x 0.5
 SKY14151-350LF	SP4T (R)	0.02–2.5	0.4–0.5	29–23	60	37	QFN-16 3 x 3 x 0.45







Discrete

PIN Diode Chips—Low Frequency to 20 GHz



Part Number	V _B @ 10 μA (V)	Nominal I-Region (μm)	Typ. C _J @ 0 V (pF)	Max. C _J @ 50 V (pF)	Max. R _S @ 10 mA (Ω)	Max. T _I @ 10 mA (ns)	Max. Thermal Resistance (C/W)
 APD0505-000	50	5	0.10	0.05	2.0	20	100
 APD0510-000	50	5	0.20	0.10	1.5	40	80
 APD0520-000	50	5	0.25	0.20	1.0	50	80
 APD0805-000	100	8	0.10	0.05	2.0	100	80
 APD0810-000	100	8	0.15	0.10	1.5	160	60
 APD1510-000	200	15	0.20	0.10	2.0	300	60
 APD1520-000	200	15	0.25	0.20	1.2	900	30

PIN Diode Wafer on Film Frame—Low Frequency to 20 GHz

Part Number	V _B @ 10 μA (V)	Typ. C _J @ 0 V (pF)	Max. C _J @ 30 V (pF)	Typ. V _F @ 10 mA (mV)	Max. R _S @ 1 mA (Ω)	Max. R _S @ 10 mA (Ω)	Max. T _I @ 10 mA (ns)	Nominal Chip Size (mils)	Nominal Contact Diameter (mils)
 SMP1320-099	50	0.23	0.175	850	2 Typ.	0.9	400	13.5	3.0
 SMP1321-099	100	0.18	0.15	860	2	5 Typ.	400	13.5	3.0
 SMP1322-099	50	1.10	0.85	825	1.5	0.45 Typ.	400	13.5	7.5
 SMP1340-099	50	0.20	0.15 @ 10 V	880	1.7 Typ.	1.2	100	10.1	3.0
 SMP1353-099	100	0.35	0.15 @ 10 V	825	15	2.8	1000	10.1	8.0

RF Switching (continued)

Plastic Surface Mount (SMT) PIN Diodes, High Power Switching—Low Frequency to 6 GHz

Part Number	Min. V_B $I_R = 10 \mu A$ (V)	Max. C_T $V_R = 30 V$ $F = 1 MHz$ (pF)	Typ. V_F @ $I_F = 10 mA$ (V)	Max. R_S $I_F = 1 mA$ $F = 100 MHz$ (Ω)	Max. R_S $I_F = 10 mA$ $F = 100 MHz$ (Ω)	Max. R_S $I_F = 100 mA$ $F = 100 MHz$ (Ω)	Typ. T_L $I_F = 10 mA$ (ns)	Nominal I-Region Thickness (μm)
SMP1302 Series	200	0.3	0.8	20	3	1.5	700	50
 SMP1324-087LF	200	1.5	0.7	–	–	0.75 @ 50 mA	6 μs	100
 SMP1371-087LF	35	1.2 @ 20 V	0.8	–	0.5	–	300	12

Plastic Surface Mount (SMT) PIN Diodes—Low Frequency to 6 GHz

Part Number	Min. V_B $I_R = 10 \mu A$ (V)	Max. C_T $V_R = 30 V$ $F = 1 MHz$ (pF)	Typ. V_F @ $I_F = 10 mA$ (V)	Typ. R_S $I_F = 1 mA$ $F = 100 MHz$ (Ω)	Max. R_S $I_F = 10 mA$ $F = 100 MHz$ (Ω)	Typ. T_L $I_F = 10 mA$ (ns)	Nominal I-Region Thickness (μm)
SMP1320 Series	50	0.3	0.85	2	0.9	400	8

Low Capacitance Switching PIN Diodes

Part Number	Min. V_B $I_R = 10 \mu A$ (V)	Max. C_T $V_R = 30 V$ $F = 1 MHz$ (pF)	Typ. V_F @ $I_F = 10 mA$ (V)	Typ. R_S $I_F = 1 mA$ $F = 100 MHz$ (Ω)	Max. R_S $I_F = 10 mA$ $F = 100 MHz$ (Ω)	Typ. T_L $I_F = 10 mA$ (ns)	Nominal I-Region Thickness (μm)
SMP1321 Series	100	0.25	0.85	3	2	400	15

RF Switching (continued)

Lowest Series Resistance Switching PIN Diodes

Part Number	Min. V_B $I_R = 10 \mu\text{A}$ (V)	Max. C_T $V_R = 30 \text{ V}$ $F = 1 \text{ MHz}$ (pF)	Typ. V_F @ $I_F = 10 \text{ mA}$ (V)	Max. R_S $I_F = 1 \text{ mA}$ $F = 100 \text{ MHz}$ (Ω)	Typ. R_S $I_F = 10 \text{ mA}$ $F = 100 \text{ MHz}$ (Ω)	Typ. T_L $I_F = 10 \text{ mA}$ (ns)	Nominal I-Region Thickness (μm)
SMP1322 Series	50	1	0.825	1.5	0.5	400	8

Low Capacitance Fast Switching PIN Diodes

Part Number	Min. V_B $I_R = 10 \mu\text{A}$ (V)	Max. C_T $V_R = 5 \text{ V}$ $F = 1 \text{ MHz}$ (pF)	Typ. V_F @ $I_F = 10 \text{ mA}$ (V)	Typ. R_S $I_F = 1 \text{ mA}$ $F = 100 \text{ MHz}$ (Ω)	Max. R_S $I_F = 10 \text{ mA}$ $F = 100 \text{ MHz}$ (Ω)	Typ. T_L $I_F = 10 \text{ mA}$ (ns)	Nominal I-Region Thickness (μm)
SMP1340 Series	50	0.3	0.88	1.7	1.2	100	7

Lowest Capacitance Switching PIN Diodes for High Isolation

Part Number	Min. V_B $I_R = 10 \mu\text{A}$ (V)	Max. C_T $V_R = 20 \text{ V}$ $F = 1 \text{ MHz}$ (pF)	Typ. V_F @ $I_F = 10 \text{ mA}$ (V)	Typ. R_S $I_F = 1 \text{ mA}$ $F = 100 \text{ MHz}$ (Ω)	Max. R_S $I_F = 10 \text{ mA}$ $F = 100 \text{ MHz}$ (Ω)	Typ. T_L $I_F = 10 \text{ mA}$ (ns)	Nominal I-Region Thickness (μm)
SMP1345 Series	50	0.2	0.89	3.5	2	100	10

Large Signal Switching PIN Diodes

Part Number	Min. V_B $I_R = 10 \mu\text{A}$ (V)	Max. C_T $V_R = 20 \text{ V}$ $F = 1 \text{ MHz}$ (pF)	Typ. V_F @ $I_F = 10 \text{ mA}$ (V)	Max. R_S $I_F = 1 \text{ mA}$ $F = 100 \text{ MHz}$ (Ω)	Max. R_S $I_F = 10 \text{ mA}$ $F = 100 \text{ MHz}$ (Ω)	Typ. T_L $I_F = 10 \text{ mA}$ (ns)	Nominal I-Region Thickness (μm)
SMP1352 Series	200	0.35	0.8	15	2.8	1000	50

Receiver Protection

Discrete limiter PIN and Schottky diodes provide the necessary receiver protection needed to prevent receiver damage. High power signals are attenuated while lower power signals are passed. Skyworks features many different diode configurations of packaged devices and dice. A listing of these products follow.

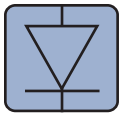

Discrete

Limiter Diode Chips—Low Frequency to 20 GHz

Part Number	V_B @ 10 μ A (V)	Nominal I-Region Thickness (μ m)	Typ. C_j @ 0 V (pF)	Max. C_j @ 6 V (pF)	Max. R_s @ 10 mA (Ω)	Max. T_L @ 10 mA (ns)	Thermal Impedance	
							Max. Average (C/W)	Typ. 1 μ s Pulse (C/W)
CLA4601-000	15–30	1.0	0.12	0.10	2.5	5	120	15
CLA4602-000	15–30	1.0	0.20	0.15	2.0	5	80	10
CLA4603-000	20–45	1.5	0.20	0.15	2.0	5	100	10
CLA4604-000	30–60	2.0	0.12	0.10	2.5	7	100	10
CLA4605-000	30–60	2.0	0.20	0.15	2.0	7	70	7.0
CLA4606-000	45–75	2.5	0.20	0.15	2.0	10	80	7.0
CLA4607-000	120–180	7.0	0.20	0.15 @ 50 V	2.0	50	40	1.2
CLA4608-000	120–180	7.0	0.80	0.5 @ 50 V	1.2	100	15	0.3
CLA4609-000	250 (Min.)	28.0	0.26	0.14	1.5	1175	15	0.3

Plastic Surface Mount (SMT) Limiter Diodes—Low Frequency to 6 GHz

Part Number	V_B @ $I_R = 10 \mu$ A (V)	Nominal I-Region Thickness (μ m)	C_j 0 V, F = 1 MHz (pF)	C_j 0 V, F = 1 GHz (pF)	R_s $I_F = 10$ mA, F = 100 MHz (Ω)	Typ. T_L $I_F = 10$ mA (ns)	Package (mm)
SMP1330 Series	20–50	3	0.7 Typ., 1.0 Max.	0.7 Typ.	1.25 Typ., 1.5 Max.	4.0 Typ.	SOT-23 2.37 x 2.92 x 1
CLA4609-086LF	250	28	0.6 Max. @ 30 V	–	1.5 Max.	1.1 μ s	QFN-2 2 x 2 x 0.9

Hermetic Packaged Limiter Diodes

Hermetic Stripline 240	Hermetic Pill 203	Hermetic Pill 219	Hermetic Pill 210
CLA4601-240	CLA4601-203	CLA4601-219	CLA4601-210
CLA4602-240	CLA4602-203	CLA4602-219	CLA4602-210
CLA4603-240	CLA4603-203	CLA4603-219	CLA4603-210
CLA4604-240	CLA4604-203	CLA4604-219	CLA4604-210
CLA4605-240	CLA4605-203	CLA4605-219	CLA4605-210
CLA4606-240	CLA4606-203	CLA4606-219	CLA4606-210
CLA4607-240	CLA4607-203	CLA4607-219	CLA4607-210
CLA4608-240	CLA4608-203	CLA4608-219	CLA4608-210
CLA4609-240	CLA4609-203	CLA4609-219	CLA4609-210



Low Noise Amplifiers

Low noise amplifiers improve overall receiver sensitivity and determine system noise performance. Skyworks offers integrated LNAs with active bias circuitry down to discrete packaged GaAs low noise transistors for custom applications. A listing of our products follow.



MMIC

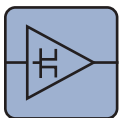

Low Noise Amplifiers

Part Number	Frequency Range (GHz)	Test Frequency (GHz)	Gain Typ. (dB)	OIP3 (dBm)	OP _{1dB} (dBm)	V _{DD} (V)	Supply Current Typ. (mA)	Noise Figure Typ. (dB)	Package (mm)
 SKY67100-396LF	1.7–2.0	1.85	18.5	34.0	19	4	56	0.55	DFN-8 2 x 2 x 0.75
 SKY67101-396LF	0.7–1.0	0.90	17.9	34.0	19	4	56	0.50	DFN-8 2 x 2 x 0.75
 SKY65066-360LF	2.30–2.7	2.500	16.5	35.5	18	5	75	0.70	DFN-8 2 x 2 x 0.9



Discrete

Low Noise Discrete Transistors

Part Number	Frequency Range (GHz)	Test Frequency (GHz)	Gain Typ. (dB)	OIP3 Typ. (dBm)	P _{1dB} (dBm)	V _{CC} (V)	NF (dB) ⁽¹⁾	Quiescent Current Typ. (mA)	Package (mm)
 SKY65050-372LF	0.45–6	2.4	15.5	23.5	10.5	3	0.65	20	4-pin SC-70 2.2 x 1.35 x 1.1
 SKY65053-377LF	0.45–6	2.4	16.5	33.5	15.5	5	0.80	55	DFN-4 2 x 2 x 0.55

Gain Blocks and Power Amplifiers

Gain block amplifiers are used throughout the transceiver design to provide high linearity and low noise signal amplification. Skyworks gain blocks are 50 ohm matched and can be cascaded without external impedance matching networks for RF and IF applications. These amplifiers are also used as drivers for higher power amplifier stages. Please refer to our product listing that follows.

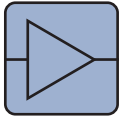

MMIC

General-Purpose (Gain Block) Amplifiers

Part Number	Frequency Range (GHz)	Test Frequency (GHz)	Gain Typ. (dB)	IIP3 (dBm)	OIP3 (dBm)	OP _{1dB} (dBm)	Supply Voltage (V)	Supply Current Typ. (mA)	Noise Figure Typ. (dB)	Package (mm)
SKY65038-70LF	0.25–6.0	1.00	15.0	25.0	40.0	21.5	5.0	150	2.0	4-pin SOT-89 4.5 x 2.4 x 1.5
SKY65045-70LF	0.39–1.5	0.9	14.3	23.7	38.0	24.7	5.0	130	1.8	4-pin SOT-89 4.5 x 2.4 x 1.5
SKY65080-70LF	1.5–2.5	1.85	15.0	25.5	40.5	21.0	5.0	75	2.3	4-pin SOT-89 4.5 x 2.4 x 1.5
SKY65081-70LF	2.0–3.0	2.60	14.3	29.6	43.9	22.3	5.0	70	2.0	4-pin SOT-89 4.5 x 2.4 x 1.5
SKY65013-214LF	0.25–8.0	2.00	11.5	17.5	29.0	12.5	3.5	40	5.4	4-pin Micro-X 5.08 x 5.08 x 1.52
SKY65014-92LF	0.25–9.0	2.00	15.0	21.0	36.0	18.0	5.0	70	5.4	SC-88 2.0 x 2.2 x 0.95
SKY65015-92LF	0.25–6.0	2.00	18.0	17.0	35.0	18.0	5.0	70	4.8	SC-88 2.0 x 2.2 x 0.95
SKY65016-92LF	0.25–3.0	2.00	20.0	7.0	27.0	14.0	3.5	40	5.4	SC-88 2.0 x 2.2 x 0.95
SKY65017-70LF	0.25–6.0	2.00	20.0	15.0	35.0	20.0	5.0	100	4.5	4-pin SOT-89 4.5 x 2.4 x 1.5
SKY65162-70LF	0.40–2.70	2.40	13.2	30.6	43.8	30.0	5.0	400	3.9	4-pin SOT-89 4.5 x 2.4 x 1.5

Power Amplifiers

Part Number	Frequency Range (GHz)	Test Frequency (GHz)	Gain Typ. (dB)	OIP3 (dBm)	P _{1dB} (dBm)	V _{CC} (V)	Quiescent Current Typ. (mA)	Noise Figure Typ. (dB)	Package (mm)
SKY65028	0.25–2.7	1.96	16	42	25	3.3 or 5	125	5.5	4-pin SOT-89 4.5 x 2.4 x 1.5
SKY65120	2.110–2.170	2.14	24.6	48	33.5	5	447	8.4	20-pin MCM 6 x 6 x 1.45
SKY65124	1.930–1.990	1.96	24	45	33	5	550	6.3	20-pin MCM 6 x 6 x 1.45
SKY65126-21	0.800–0.900	0.85	30	48	32.5	5	283	4.5	20-pin MCM 6 x 6 x 1.45
SKY65127	0.700–0.800	0.75	36.5	44	32.5	5	264	4.4	20-pin MCM 6 x 6 x 1.45
SKY65170	0.860–0.900	0.880	32	45	28	5	200	6.5	20-pin MCM 6 x 6 x 1.35
SKY65171	1.930–1.990	1.960	27	36	28	5	200	6.5	20-pin MCM 6 x 6 x 1.35





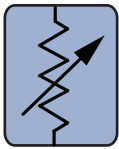



Gain Control Attenuation

Skyworks has a large selection of digital attenuators to dynamically attenuate signals in receive and transmit signal paths. Digital attenuators are controlled by serial or parallel interfaces and offer down to 0.25 dB attenuation bit accuracy. Our listing of our attenuator products follow.



MMIC

Digital Attenuators

Part Number	Frequency (GHz)	Control Bits/ Interface Parallel/Serial	Attenuation Range (dB)	LSB Attenuation (dB)	Typ. IL (dB)	Typ. IIP3 (dBm)	Typ. IP _{1dB} (dBm)	Package (mm)
AA103-72LF	LF-2.5	1/P	10.0	10.0	0.3-0.4	41	20	SOT-5 2.8 x 2.9 x 1.18
AA116-72LF	LF-2.0	1/P	15.0	15.0	0.35-0.4	41	20	SOT-5 2.8 x 2.9 x 1.18
 SKY12406-360LF	0.05-0.60	1/P	12.0	12.0	0.3	46	22	DFN-8 2 x 2 x 0.9
 SKY12407-321LF	0.05-0.60	1/P	12.0	12.0	0.3	48	31	QFN-12 3 x 3 x 0.75
SKY12324-73LF	0.5-3.0	2/P	12.0	4.0	0.9-1.3	43	30	SOT-6 2.8 x 2.9 x 1.18
 SKY12338-337LF	0.35-4.0	2/P	18.0	6.0	0.55-1.3	45	30	QFN-12 3 x 3 x 0.9
SKY12325-350LF	0.5-6.0	3/P	7.0	1.0	0.7-1.3	47	27	QFN-16 3 x 3 x 0.75
AA210-25LF	LF-2.0	4/P	15.0	1.0	0.9-2.1	48	28	SOIC-16 10 x 6 x 1.7
AA264-87LF	0.5-2.0	4/P	30.0	2.0	1.6-1.8	36	15	TSSOP-16 6.4 x 5 x 1
AA101-80LF	0.5-2.5	5/P	31.0	1.0	2.0-2.9	41	21	SSOP-16 6 x 4.9 x 1.6
AA102-80LF	0.5-2.5	5/P	15.5	0.5	1.9-3.2	42	24	SSOP-16 6 x 4.9 x 1.6
SKY12322-86LF	0.5-4.0	5/P	15.5	0.5	1.4-3.0	45	27	MSOP-10 4.9 x 3 x 0.96
SKY12323-303LF	0.5-3.0	5/P	31.0	1.0	1.4-2.3	48	30	MSOP-10EP 4.9 x 3 x 0.96
SKY12328-350LF	0.5-4.0	5/P	15.5	0.5	1.1-2.3	42	30	QFN-16 3 x 3 x 0.75
 SKY12339-350LF	0.4-3.0	5/P	31.0	1.0	1.2-2.0	39	-	QFN-16 3 x 3 x 0.75
AA109-310LF	0.5-2.5	5/S	31.0	1.0	2.0-3.1	41	21	QFN-32 5 x 5 x 0.9
 SKY12340-364LF	LF-2.0	5/S	15.5	0.5	1.4-1.8	45	30	QFN-32 5 x 5 x 0.9
 SKY12345-362LF	0.7-4.0	5/S	15.5	0.5	1.2-2.0	42	32	QFN-24 4 x 4 x 0.9
AA113-310LF	LF-1.0	6/P	31.5	0.5	1.5-1.8	48	29	QFN-32 5 x 5 x 0.9
 SKY12347-362LF	DC-3.0	6/P, S	31.5	0.5	1.2-2.0	50	30 (0.1)	QFN-24 4 x 4 x 0.9
 SKY12343-364LF	0.1-4.0	7/P, S	31.5	0.5	1.8-2.0	55	32	QFN-32 5 x 5 x 0.9

Gain Control Attenuation (continued)

0.7–2.3 GHz Plastic Packaged Voltage Variable Attenuators—PIN Diode-Based

Part Number	Frequency (GHz)	Description	Insertion Loss at Min. Control (dB) Max.	Attenuation Range at Max. Control (dB) Typ.	Input IP3 (dBm) Min.	Control Input Range	Package (mm)
AV101-12LF	0.7–1.0	HIP3™ Variable Attenuator	1.5	20	47	0–3.0 mA	SOIC-8 6 x 4.9 x 1.6
AV102-12LF	1.7–2.0	HIP3™ Variable Attenuator	1.5	20	47	0–3.0 mA	SOIC-8 6 x 4.9 x 1.6
AV111-12LF	0.8–1.0	HIP3™ Variable Attenuator	1.5	25	37	0–1.4 mA	SOIC-8 6 x 4.9 x 1.6
AV113-12LF	2.0–2.3	HIP3™ Variable Attenuator	1.6	22	37	0–1.5 mA	SOIC-8 6 x 4.9 x 1.6
SKY12143-315	0.869–0.894 0.925–0.960	HIP3™ Variable Attenuator	1.5	23	43	0–12 V	LGA Surface Mount 4.9 x 3.2 x 2.32
SKY12144-315	1.805–1.870 1.930–1.990	HIP3™ Variable Attenuator	1.5	23	43	0–12 V	LGA Surface Mount 4.9 x 3.2 x 2.32
SKY12145-315	2.110–2.170	HIP3™ Variable Attenuator	1.5	23	43	0–12 V	LGA Surface Mount 4.9 x 3.2 x 2.32

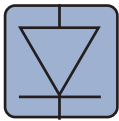

Discrete

Low-Distortion Attenuator PIN Diodes

Part Number	Min. V_B $I_R = 10 \mu\text{A}$ (V)	Max. C_T $V_R = 30 \text{ V}$ $F = 1 \text{ MHz}$ (pF)	Typ. V_F @ $I_F = 10 \text{ mA}$ (V)	Max. R_S $I_F = 1 \text{ mA}$ $F = 100 \text{ MHz}$ (Ω)	Max. R_S $I_F = 10 \text{ mA}$ $F = 100 \text{ MHz}$ (Ω)	Max. R_S $I_F = 100 \text{ mA}$ $F = 100 \text{ MHz}$ (Ω)	Typ. T_L $I_F = 10 \text{ mA}$ (ns)	Nominal I-Region Thickness (μm)
SMP1304 Series	200	0.3	0.8	50	7	2	1000	100

Lowest Distortion, High IP3 Attenuator PIN Diodes

Part Number	Min. V_B $I_R = 10 \mu\text{A}$ (V)	Max. C_T $V_R = 30 \text{ V}$ $F = 1 \text{ MHz}$ (pF)	Typ. V_F @ $I_F = 10 \text{ mA}$ (V)	Max. R_S $I_F = 1 \text{ mA}$ $F = 100 \text{ MHz}$ (Ω)	Max. R_S $I_F = 10 \text{ mA}$ $F = 100 \text{ MHz}$ (Ω)	Max. R_S $I_F = 100 \text{ mA}$ $F = 100 \text{ MHz}$ (Ω)	Typ. T_L $I_F = 10 \text{ mA}$ (ns)	Nominal I-Region Thickness (μm)
SMP1307 Series	200	0.3	0.85	100	15	3	1500	175

PIN Diode Chips Supplied On Film Frame for Attenuator Applications—Low Frequency to 10 GHz

Part Number	V_B @ $10 \mu\text{A}$ (V)	Typ. C_J @ 0 V (pF)	Max. C_J @ 30 V (pF)	Typ. V_F @ 10 mA (mV)	Max. R_S @ 1 mA (Ω)	Max. R_S @ 10 mA (Ω)	Max. T_L @ 10 mA (ns)	Nominal Chip Size (mils)	Nominal Contact Diameter (mils)
SMP1302-099	200	0.27	0.15	800	20	3	700	13.5	8.5
SMP1304-099	200	0.18	0.15	800	50	7	1000	13.5	8.5

Gain Control Attenuation (continued)

Fixed Attenuator Pads

The ATN3590 family of fixed resistive attenuators are integrated circuits comprising thin film resistors and through-die vias that provide excellent attenuation flatness from low frequency to 40 GHz. These attenuators are available in die form from 0 to 30 dB. Please refer to the following product listing.

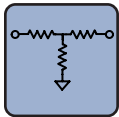

Discrete

Series	Available Attenuation Values (dB)	Grounding Method	Die Size (mm)
ATN3590	0-10, 12, 15, 20, 30	Through die vias	0.700 x 0.725 x 0.10

Mixers

Skyworks offers a diverse portfolio of mixers for up/down frequency conversion for transceiver applications. MCM products are also offered which integrate multiple mixers for diversity applications as well as driver amplifiers for local oscillators. Please refer to the following product listing.

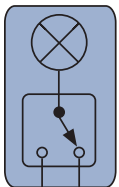

MCM

Single Mixers

Part Number	RF Frequency (MHz)	IF Frequency (MHz)	OIP3 (dBm)	Gain (dB)	IP _{1dB} (dBm)	LO-RF (dB)	LO-IF (dB)	NF (dB)	Package (mm)
-------------	--------------------	--------------------	------------	-----------	-------------------------	------------	------------	---------	--------------

Single Downconversion Mixers



SKY73032	700–1000	40–300	27.0	9.5	13.3	-59.0	-34.0	8.3	20-pin MCM 5 x 5 x 1.1
SKY73033	1700–2100	50–300	24.0	8.9	15.1	-37.0	-56.0	9.4	20-pin MCM 5 x 5 x 1.1
SKY73035	2300–2700	50–500	25.0	7.6	13.5	-29.0	-67.0	9.8	20-pin MCM 5 x 5 x 1.1
SKY73070	700–1000	40–300	27.0	9.5	13.3	-59.0	-34.0	8.3	20-pin MCM 5 x 5 x 1.1

Mixers (continued)

Single Mixers (continued)

Part Number	RF Frequency (MHz)	IF Frequency (MHz)	IIP3 (dBm)	Gain (dB)	IP ₁ (dBm)	LO-RF (dB)	LO-IF (dB)	NF (dB)	Package (mm)
-------------	--------------------	--------------------	------------	-----------	-----------------------	------------	------------	---------	--------------









Single Up/Downconversion Mixers

 SKY73062	700–1000	50–300	32.6	-7.5	20.0	-35.0	-40.5	7.5	20-pin MCM 5 x 5 x 1.05
 SKY73063	1700–2100	100–200	30.7	-6.8	19.0	-35.0	-40.0	6.8	20-pin MCM 5 x 5 x 1.05
 SKY73069	1700–2200	50–500	33.5	-7.2	20.9	-27.0	-25.0	6.8	20-pin MCM 5 x 5 x 1.05

Dual Mixers

Part Number	RF Frequency (MHz)	IF Frequency (MHz)	IIP3 (dBm)	Gain (dB)	IP ₁ (dBm)	LO-RF (dB)	LO-IF (dB)	NF (dB)	Package (mm)
-------------	--------------------	--------------------	------------	-----------	-----------------------	------------	------------	---------	--------------

Dual Downconversion Mixers

SKY73021	1700–2200	40–300	26.0	6.0	17.0	-41.0	-50.0	9.6	36-pin MCM 6 x 6 x 1.1
SKY73022	700–1000	40–300	25.3	9.4	13.3	-46.0	-44.0	9.0	36-pin MCM 6 x 6 x 1.1
SKY73023	1700–2200	40–300	25.7	9.7	13.6	-38.0	-45.0	9.9	36-pin MCM 6 x 6 x 1.1
SKY73025	2300–2700	50–300	23.5	8.6	12.3	-30.0	-20.0	9.8	36-pin MCM 6 x 6 x 1.1
 SKY73075	2300–2400	50–500	23.5	8.9	13.3	-54.0	-50.0	8.8	20-pin MCM 5 x 5 x 1.05
 SKY73083	1700–2200	50–500	26.0	9.0	13.6	-25.0	-40.0	8.9	36-pin MCM 6 x 6 x 1.05
 SKY73084	300–500	50–250	25.2	9.8	13.2	-40.0	-40.0	9.4	36-pin MCM 6 x 6 x 1.1
 SKY73085	390–500	40–250	24.9	9.8	12.9	-30.0	-40.0	9.3	36-pin MCM 6 x 6 x 1.1
 SKY73086	650–850	100–500	33.1	8.7	12.0	-32.0	-26.0	11.0	36-pin MCM 6 x 6 x 1.1
 SKY73087	700–1000	100–500	25.3	8.8	12.7	-36.0	-40.0	10.7	36-pin MCM 6 x 6 x 1.05
 SKY73089	1200–1700	50–500	26.8	9.3	13.9	-25.0	-40.0	9.3	36-pin MCM 6 x 6 x 1.1
 SKY73090	1700–2200	50–500	24.2	8.7	13.3	-25.0	-40.0	9.4	36-pin MCM 6 x 6 x 1.05

Discrete

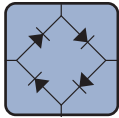

Discrete

Beam-Lead Ring Quad, N-Type, Low, Medium, High Drive Schottky Diodes— Low Frequency to 40 GHz

Part Number	Frequency Band	C_j 0 V, 1 MHz (pF)	Max. R_s @ 5 mA (Ω)	Min. V_b @ 10 μ A (V)	V_f @ 1 mA (mV)	Drive Level
DMF2865-000	S	0.30–0.50	5	2	200–260	Low
DME2857-000	S	0.30–0.50	5	3	300–400	Med
DMJ2502-000	S	0.30–0.50	5	4	500–600	High
DMF2011-000	X	0.15–0.30	8	2	250–310	Low
DME2858-000	X	0.15–0.30	8	3	325–425	Med
DMJ2990-000	X	0.15–0.30	8	4	550–650	High
DMF2012-000	Ku	0.05–0.15	13	2	260–330	Low
DME2859-000	Ku	0.05–0.15	13	3	350–450	Med
DMJ2667-000	Ku	0.05–0.15	13	4	500–680	High
DMF2454-000	K	0.1 Max.	18	2	270–350	Low
DME2459-000	K	0.1 Max.	18	3	375–550	Med
DMJ2455-000	K	0.1 Max.	18	4	600–700	High

Beamless, N-Type, Low, Medium, High Drive Ring Quad Schottky Diodes—Low Frequency to 24 GHz

Part Number	Band	Barrier	V_f @ 1 mA (mV)	ΔV_f @ 1 mA (mV)	C_j $V_R = 0$ V, $F = 1$ MHz (pF)	R_s @ 5 mA (Ω)
DMF3926-000	S	Low	200–260	10	0.30–0.50	5
DME3927-000	S	Medium	300–400	10	0.30–0.50	5
DMJ3928-000	S	High	500–600	10	0.30–0.50	5
DMF3942-000	X	Low	250–310	10	0.15–0.30	8
DME3943-000	X	Medium	325–425	10	0.15–0.30	8
DMJ3944-000	X	High	550–650	10	0.15–0.30	8

Epoxy Octo Ring Quad Schottky Diodes—Microwave



Epoxy Packaged Octo Quad Ring, N-Type, Low, Medium, High Drive Schottky Diodes—
Low Frequency to 20 GHz

Part Number	Frequency Band	C_j 0 V, 1 MHz (pF)	Max. R_s @ 5 mA (Ω)	Min. V_b @ 10 μ A (V)	V_f @ 1 mA (mV)	Drive Level
DMF3938-257	S–X	0.15–0.30	16	4	400–520	Low
DME3939-257	S–X	0.15–0.30	16	6	600–800	Medium
DMJ3940-257	S–X	0.15–0.30	16	8	1000–1200	High

Hybrid Couplers

Skyworks offers MMIC hybrid couplers in surface mount packages for wireless infrastructure applications. These 90-degree couplers are used in balanced amplifiers, analog variable attenuators, and for the generation of quadrature signals. Please refer to the following product listing.



MMIC

90-Degree Hybrid Couplers

Part Number	Frequency (GHz)	Insertion Loss (dB) Typ.	Isolation (dB) Typ.	Input VSWR Typ.	Output VSWR Typ.	Amplitude Balance (Degrees) Typ.	Phase Balance (dB) Typ.	Package
HY17-12LF	1.71–1.88	0.50	20	1.2:1	1.2:1	±0.5	±1	SOIC-8 6 x 4.9 x 1.6
HY19-12LF	1.85–1.99	0.50	20	1.3:1	1.3:1	±0.5	±1	SOIC-8 6 x 4.9 x 1.6
HY22-73LF	2.10–2.30	0.55	23	1.2:1	1.2:1	±0.4	±2	SOT-6 2.8 x 2.9 x 1.18
HY86-12LF	0.82–0.90	0.40	30	1.15:1	1.15:1	±0.5	±1	SOIC-8 6 x 4.9 x 1.6
HY92-12LF	0.88–0.96	0.40	25	1.1:1	1.1:1	±0.5	±1	SOIC-8 6 x 4.9 x 1.6

Directional Couplers

Skyworks Solutions offers a broad selection of wideband directional couplers in low profile SOT-6 surface mount packages for wireless infrastructure applications. These products offer excellent insertion loss, very good directivity, high isolation and low input/output VSWR. Please refer to the following product listing.

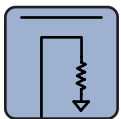

MMIC

Part Number	Frequency (GHz)	Insertion Loss (dB) Typ.	Isolation (dB) Typ.	Input VSWR Typ.	Output VSWR Typ.	Coupling (dB) Typ.	Coupled Port VSWR Typ.	Package
DC08-73LF	0.81–0.96	0.45	22	1.05:1	1.05:1	15.0	1.2:1	SOT-6 2.8 x 2.9 x 1.18
DC09-73LF	0.81–0.96	0.20	30	1.1:1	1.1:1	19.8	1.1:1	SOT-6 2.8 x 2.9 x 1.18
DC15-73LF	1.42–1.66	0.20	34	1.1:1	1.1:1	18.4	1.1:1	SOT-6 2.8 x 2.9 x 1.18
DC16-73LF	1.42–1.99	0.30	24	1.1:1	1.1:1	15.0	1.1:1	SOT-6 2.8 x 2.9 x 1.18
DC18-73LF	1.71–1.99	0.20	38	1.1:1	1.1:1	18.8	1.2:1	SOT-6 2.8 x 2.9 x 1.18
DC25-73LF	2.30–2.60	0.20	33	1.1:1	1.1:1	17.2	1.3:1	SOT-6 2.8 x 2.9 x 1.18

Power Detectors

Skyworks' SMS series of Schottky diodes are used extensively in transceiver designs for power detection. Detectors are commonly used as level detectors in wireless and other RF and microwave signal processors. Detector designs are simple to realize using our low-cost, plastic packaged diodes. Skyworks also has a comprehensive library of application notes available to help with customers' designs. Please refer to the following product listing.

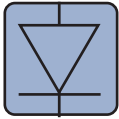

Discrete

Plastic Surface Mount (SMT) Schottky Diodes—Low Frequency to 24 GHz

Part Number	Min. V_B $I_R = 10 \mu A$ (V)	Typ. I_R $V_R = 1 V$ (nA)	Max. V_F $I_F = 1 mA$ (mV)	Max. C_T $V_R = 0 V$ (pF)	Max. R_T $I_F = 10 mA$ (Ω)
SMS7621 Series	2	80	320	0.25	18

Surface Mount Silicon Schottky Mixer and Detector Diodes—Low Frequency to 100 GHz

Part Number	Min. V_B $I_B = 10 \mu A$ (V)	Max. C_T $@ 0 V$ (pF)	Typ. C_T $@ 0.15 V$ (pF)	V_F $@ 0.1 mA$ (mV)	V_F $@ 1.0 mA$ (mV)	Series Resistance (Ω)	Video Resistance $@ 0 V$ (Ω)	Package (mm)
SMS7621-060	2	0.18	–	–	260–320	12	–	0201 0.6 x 0.3 x 0.27
SMS7630-061	1	–	0.3	60–120	135–240	–	3000–7000	0201 0.6 x 0.3 x 0.27

Modulators/Demodulators

The SKY73010 is an integrated quadrature modulator for direct modulation of high-frequency Amplitude Modulated (AM), Phase Modulated (PM), or compound carriers. A SiGe Bipolar Complementary Metal Oxide Semiconductor (BiCMOS) process is used to offer excellent linearity, noise floor, and carrier suppression performance.

Skyworks offers mixers, demodulators and modulators in an integrated LGA package. Solutions for direct quadrature modulators and demodulators are available. Our product offering is contained below.

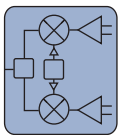

IQ Demodulators

Part Number	RF Input Frequency Range (MHz)	IF Output Frequency Range	Voltage (V)	IIP2 (dBm)	IIP3 (dBm)	Voltage Conversion Gain (dB)	Package (mm)
SKY73001	2–3500	DC–100	3	67 @ 900 MHz	27 @ 900 MHz	-3.5 @ 900 MHz	32-pin RFLGA 5 x 5 x 1
SKY73009	400–3000	DC–250	3	60 @ 900 MHz	27 @ 900 MHz	2 @ 900 MHz	32-pin RFLGA 5 x 5 x 1
SKY73012	400–3900	DC–250	3	60 @ 900 MHz	29 @ 900 MHz	1 @ 900 MHz	32-pin RFLGA 5 x 5 x 1

Modulators/Demodulators (continued)

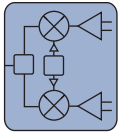

IQ Modulators

Part Number	RF Output Frequency Range	Broadband Noise Floor (dBm/Hz)	Baseband Input Frequency Range (MHz)	ACPR (dBc)	IIP3 (dBm)	Package (mm)
SKY73010-21	300–2500	<-153	DC–250	-72	-72	16-pin RFLGA 4 x 4 x 1

VCOs/Synthesizers

Skyworks offers high-performance signal sources for high dynamic range transceiver applications. Single and dual fractional N synthesizers and high-performance VCO/synthesizers are offered in both MCM and MMIC products. Please refer to the following product listing.

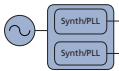

MCM

Part Number	Main Synthesizer Frequency (MHz)	RF Output Frequency Range (MHz)	Output Power (dBm)	Auxiliary Synthesizer Frequency (MHz)	Main Synthesizer Phase Noise (dBc/Hz)	Phase Noise @ 100 kHz (dBc/Hz)	Phase Noise @ 200 kHz (dBc/Hz)	Phase Settling Time (μs)	Current Consumption (mA)	Supply Voltage (V)	Package (mm)
SKY72300-21	100–2100	–	–	100–500	-91 @ 1800 MHz	–	–	–	–	2.7-3.3	28-pin EP-TSSOP 9.7 x 6.4 x 0.9
SKY72300-362	100–2100	–	–	100–500	-91 @ 1800 MHz	–	–	–	–	2.7-3.3	24-pin QFN 4 x 4 x 4 x 0.9
SKY72301-22	100–1000	–	–	100–500	-96 @ 950 MHz	–	–	–	–	2.7-3.3	28-pin EP-TSSOP 9.7 x 6.4 x 0.9
SKY72302-21	400–6100	–	–	100–1000	-80 @ 6100 MHz	–	–	–	–	2.7-3.3	28-pin EP-TSSOP 9.7 x 6.4 x 0.9
SKY72310-362LF	100–2100	–	–	–	-91 @ 1800 MHz	–	–	–	–	2.7-3.3	24-pin QFN 4 x 4 x 0.9
SKY73100	–	865–960	-0.3	–	–	–	-125	340	110	5	38-pin MCM 9 x 12 x 1.7
SKY73101	–	1930–1990	-10	–	–	–	-112	300	120	5	38-pin MCM 9 x 12 x 1.7
SKY73103-11	–	1460–1665	-10.8	–	–	–	-126	300	114	5	38-pin MCM 9 x 12 x 1.7
SKY73112-11	–	750–850	0	–	–	–	-128	300	110	5	38-pin MCM 9 x 12 x 1.7
SKY73120	–	890–960	0	–	–	–	-124	–	26	3	28-pin MCM 6 x 6 x 0.9
SKY73121-11	–	1805–1890	-10	–	–	–	–	227	114	5	38-pin MCM 9 x 12 x 1.7
SKY73126-31	–	160–165	10	–	–	–	–	5000 Max.	72	5	16-pin MCM 11.4 x 15 x 1.9
SKY73134	–	370–5600	-2 to 4	–	–	-141.9	–	1000 Max.	120	3.3	32-pin RFLGA 5 x 5 x 1
SKY74038-21	100–2600	–	–	1–800	-85 @ 2500 MHz	-115	–	–	–	2.6–3.6	20-pin TSSOP 6.5 x 4.4 x 1.0

Power Dividers/Combiners

Skyworks Solutions offers a broad selection of monolithic 2-way and 4-way power divider/combiners in surface mount packages for wireless infrastructure applications. These divider/combiners are utilized to equally split signals into in-phase signals as found in balanced signal chains, local oscillator distribution networks and more. Conversely, they can also be used to combine two or four signals while providing excellent isolation between the individual signal sources. Their low insertion loss, excellent phase and amplitude balance produce outstanding system performance. Please refer to the following product listing.

Power Dividers—2 Way

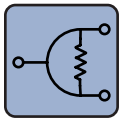

MMIC

Part Number	Frequency (GHz)	Insertion Loss Less 3 dB Split Typ.	Isolation (dB) Typ.	Input VSWR Typ.	Output VSWR Typ.	Amplitude Balance (dB)	Phase Balance (Deg.) Typ.	Total Max. Power w/2.0:1 All Ports	Package (mm)
PD09-73LF	0.81–0.96	0.40	25	1.2:1	1.3:1	±0.1	±1.0	1.5 W	SOT-6 2.8 x 2.9 x 1.18
PD15-73LF	1.42–1.66	0.40	23	1.2:1	1.2:1	±0.1	±1.0	1.5 W	SOT-6 2.8 x 2.9 x 1.18
PD16-73LF	1.42–1.66	0.40	23	1.2:1	1.2:1	±0.1	±1.0	1.5 W	SOT-6 2.8 x 2.9 x 1.18
PD18-73LF	1.71–1.99	0.40	23	1.3:1	1.2:1	±0.1	±1.0	1.5 W	SOT-6 2.8 x 2.9 x 1.18
PD19-73LF	1.71–1.99	0.55	25	1.3:1	1.2:1	±0.1	±1.0	1.5 W	SOT-6 2.8 x 2.9 x 1.18
PD22-73LF	2.10–2.30	0.55	18	1.5:1	1.1:1	±0.1	±1.0	1.5 W	SOT-6 2.8 x 2.9 x 1.18

Power Dividers—4 Way

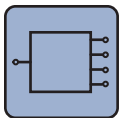

MMIC

Part Number	Frequency (GHz)	Insertion Loss Less 6 dB Split Typ.	Isolation (dB) Typ.	Input VSWR Typ.	Output VSWR Typ.	Amplitude Balance (dB)	Phase Balance (Deg.) Typ.	Total Max. Power w/2.0:1 All Ports	Package (mm)
PD4W09-12LF	0.81–0.96	1.3	23	1.2:1	1.2:1	±0.4	±6	1.5 W	SOIC-8 6 x 4.9 x 1.6
PD4W09-59LF	0.81–0.96	1.3	23	1.2:1	1.2:1	±0.4	±6	1.5 W	MSOP-8 4.9 x 3 x 1.6
PD4W18-12LF	1.71–1.99	0.7	25	1.6:1	1.2:1	±0.3	±5	1.5 W	SOIC-8 6 x 4.9 x 1.6
PD4W18-59LF	1.71–1.99	0.7	25	1.3:1	1.3:1	±0.3	±5	1.5 W	MSOP-8 4.9 x 3 x 1.6

Phase Shifters

Skyworks Solutions offers a broad selection of wideband analog phase shifters in surface mount packages for wireless infrastructure applications. These products offer excellent insertion loss, low distortion and wide phase shift range and more. Please refer to the following product listing.

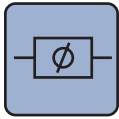

MMIC

Part Number	Frequency (MHz)	Description	Insertion Loss (dB) Max.	Phase Shift (Deg.) Min.	IP3 (dBm) Min.	Control Voltage Range (V)	Package (mm)
PS088-315	700–1100	Voltage Controlled Phase Shifter	2.8	85	33.0	0–12	LGA 4.9 x 3.2 x 2.32
PS094-315	700–1200	Voltage Controlled Phase Shifter	3.2	80	33.0	0–12	LGA 4.9 x 3.2 x 2.32
PS196-315	1500–3000	Voltage Controlled Phase Shifter	3.3	65	33.0	0–12	LGA 4.9 x 3.2 x 2.32
PS214-315	1700–2800	Voltage Controlled Phase Shifter	2.5	75	33.0	0–12	LGA 4.9 x 3.2 x 2.32

Copyright © 2010, Skyworks Solutions, Inc. All Rights Reserved.

Information in this document is provided in connection with Skyworks Solutions, Inc. (“Skyworks”) products or services. These materials, including the information contained herein, are provided by Skyworks as a service to its customers and may be used for informational purposes only by the customer. Skyworks assumes no responsibility for errors or omissions in these materials or the information contained herein. Skyworks may change its documentation, products, services, specifications or product descriptions at any time, without notice. Skyworks makes no commitment to update the materials or information and shall have no responsibility whatsoever for conflicts, incompatibilities, or other difficulties arising from any future changes.

No license, whether express, implied, by estoppel or otherwise, is granted to any intellectual property rights by this document. Skyworks assumes no liability for any materials, products or information provided hereunder, including the sale, distribution, reproduction or use of Skyworks products, information or materials, except as may be provided in Skyworks Terms and Conditions of Sale.

THE MATERIALS, PRODUCTS AND INFORMATION ARE PROVIDED “AS IS” WITHOUT WARRANTY OF ANY KIND, WHETHER EXPRESS, IMPLIED, STATUTORY, OR OTHERWISE, INCLUDING FITNESS FOR A PARTICULAR PURPOSE OR USE, MERCHANTABILITY, PERFORMANCE, QUALITY OR NON-INFRINGEMENT OF ANY INTELLECTUAL PROPERTY RIGHT; ALL SUCH WARRANTIES ARE HEREBY EXPRESSLY DISCLAIMED. SKYWORKS DOES NOT WARRANT THE ACCURACY OR COMPLETENESS OF THE INFORMATION, TEXT, GRAPHICS OR OTHER ITEMS CONTAINED WITHIN THESE MATERIALS. SKYWORKS SHALL NOT BE LIABLE FOR ANY DAMAGES, INCLUDING BUT NOT LIMITED TO ANY SPECIAL, INDIRECT, INCIDENTAL, STATUTORY, OR CONSEQUENTIAL DAMAGES, INCLUDING WITHOUT LIMITATION, LOST REVENUES OR LOST PROFITS THAT MAY RESULT FROM THE USE OF THE MATERIALS OR INFORMATION, WHETHER OR NOT THE RECIPIENT OF MATERIALS HAS BEEN ADVISED OF THE POSSIBILITY OF SUCH DAMAGE.

Skyworks products are not intended for use in medical, lifesaving or life-sustaining applications, or other equipment in which the failure of the Skyworks products could lead to personal injury, death, physical or environmental damage. Skyworks customers using or selling Skyworks products for use in such applications do so at their own risk and agree to fully indemnify Skyworks for any damages resulting from such improper use or sale.

Customers are responsible for their products and applications using Skyworks products, which may deviate from published specifications as a result of design defects, errors, or operation of products outside of published parameters or design specifications. Customers should include design and operating safeguards to minimize these and other risks. Skyworks assumes no liability for applications assistance, customer product design, or damage to any equipment resulting from the use of Skyworks products outside of stated published specifications or parameters.

Skyworks, the Skyworks symbol, “Breakthrough Simplicity,” Green, Green Initiative and Innovation to Go are trademarks or registered trademarks of Skyworks Solutions, Inc., in the United States and other countries. Third-party brands and names are for identification purposes only, and are the property of their respective owners. Additional information, including relevant terms and conditions, posted at www.skyworksinc.com, are incorporated by reference.



www.skyworksinc.com

USA

Headquarters

Skyworks Solutions, Inc.
20 Sylvan Road
Woburn, MA 01801
Telephone: (781) 376 3000
Fax: (781) 376 3100
sales@skyworksinc.com

Skyworks Solutions, Inc.
5221 California Avenue
Irvine, CA 92617
Telephone: (949) 231 3000
Fax: (949) 231 3206
kirat.hatzfeld@skyworksinc.com

Skyworks Solutions, Inc.
5520 Adamstown Road
Adamstown, MD 21710
Telephone: (301) 695 9400
Fax: (301) 695 7065
transtech@skyworksinc.com

EUROPE

Skyworks Solutions, Inc.
Parallevej 10
Lyngby 2800, Denmark
Telephone: +45 45267945
Fax: +45 45267710
jan.thoning@skyworksinc.com

Skyworks Solutions, Inc.
34 Avenue Franklin Roosevelt
Suresnes 92150, France
Telephone: +00 33 1 41443660
Fax: +00 33 1 41443661
irene.pfeiffer@skyworksinc.com

Skyworks Solutions, Ltd.
Abbey Manor Business Centre
The Abbey
Preston Road,
Yeovil, Somerset BA20 2EN
UK
Telephone: +44 1935 848546
Fax: +44 1935 431269
mike.carroll@skyworksinc.com

Skyworks Solutions, Inc.
Keilasatama 3
02150 Espoo
Finland
Telephone: +358 925107131
tommi.hiilos@skyworksinc.com

ASIA • PACIFIC

China

Skyworks Solutions Commercial
(Shenzhen) Co., Ltd. Shanghai Branch
Room 2901-02, Chong Hing
Finance Center,
No.288 Nanjing Road (W),
Shanghai, 200003 China
Telephone: +86 21 23066230
Fax: +86 21 33663398
elaine.zhao@skyworksinc.com

Skyworks Solutions, Inc.
Room 05, 11/F, Tower 2,
Kerry Plaza
No. 1 Zhongxinsi Road
Futian District
Shenzhen 518048 PRC
Telephone: +86 755 8291 3788
ext. 60017
Fax: +86 755 8293 1633
sabrina.chen@skyworksinc.com

Skyworks Solutions, Inc.
Suite 1212, COFCO, No. 8
Jianguomennei Avenue
Dongcheng District
Beijing, 100005 PRC
Telephone: +8610 652 60859
ext. 61608
Fax: +8610 852 98350
david.qi@skyworksinc.com

Japan

Skyworks Solutions, Inc.
3-20-2 Nishi-Shinjuku
Shinjuku-ku
Opera City Tower
Tokyo, 163-1436
Japan
Telephone: +81 3 5308 5180
Fax: +81 3 5308 5190
ahihiro.karikomi@skyworksinc.com

Korea

Skyworks Solutions, Inc.
648-19, Yeoksam-Dong
Seoul, Korea 135-911
Telephone: +822 3490 3816
christine.cho@skyworksinc.com

Singapore

Skyworks Solutions, Inc.
Centennial Tower
3 Temasek Avenue
Office #21-25
Singapore 039190
Telephone: +65 65497113
peter.gan@skyworksinc.com

Taiwan

Skyworks Solutions, Inc.
4 F, #198, Section 2
Tun Hwa. S. Road
Taipei 106, Taiwan ROC
Telephone: +8862 5559 8990
Fax: +8662 2735 6508
diana.wang@skyworksinc.com

Skyworks Solutions, Inc.

20 Sylvan Road, Woburn, MA 01801

USA: (781) 376-3000 • Asia: 886 2 2735 0399

Europe: 33 (0)1 41443660 • Fax: (781) 376-3100

Email: sales@skyworksinc.com • www.skyworksinc.com

BRO390-10A 9/10  Printed on Recycled Paper.

