



Chipsmall Limited consists of a professional team with an average of over 10 year of expertise in the distribution of electronic components. Based in Hongkong, we have already established firm and mutual-benefit business relationships with customers from,Europe,America and south Asia,supplying obsolete and hard-to-find components to meet their specific needs.

With the principle of "Quality Parts,Customers Priority,Honest Operation,and Considerate Service",our business mainly focus on the distribution of electronic components. Line cards we deal with include Microchip,ALPS,ROHM,Xilinx,Pulse,ON,Everlight and Freescale. Main products comprise IC,Modules,Potentiometer,IC Socket,Relay,Connector.Our parts cover such applications as commercial,industrial, and automotives areas.

We are looking forward to setting up business relationship with you and hope to provide you with the best service and solution. Let us make a better world for our industry!



## Contact us

Tel: +86-755-8981 8866 Fax: +86-755-8427 6832

Email & Skype: info@chipsmall.com Web: www.chipsmall.com

Address: A1208, Overseas Decoration Building, #122 Zhenhua RD., Futian, Shenzhen, China



## Description

Switched mode power supply (SMP) for rail mounting, three-phase supply voltage, high efficiency, integral input filter and temperature protection, high power reserve and optional parallel mode.

## Features and Benefits

- Wide range voltage input from AC 340 to 575 V
- Efficiency up to 90%
- Integral input filter and temperature protection
- Parallel mode for performance improvement (selectable by switch)

## Typical applications

Process control, industrial switch- and controlgear, machine construction, telecommunication systems

## Order numbering code

### Type No.

**SMP23** Three-phase switch-mode power supply for rail mounting

#### Connector design

**L** pcb-mounted

#### Terminal design

**20** screw terminals

#### Output voltage

**DC24V** DC 24 V

#### Output current

**10 A**

**SMP23-L20-DC24V-10A** ordering example

## Approvals

Approval authority	Standards
UL	UL508, CSA C22.2 No. 107.1 (listed) UL 60950-1, CSAC22.2 No. 60950-1 (recognized)
TÜV Rheinland	EN 60950-1 / EN 61558-1 / EN 61558-2-16

## EMC

EN 61000-6-3 / EN 61000-6-2 / EN 61204-3



**SMP23-L20-DC24V-10A**

## Technical data ( $T_U = 25^\circ\text{C}$ , $U_B = \text{AC } 400\text{...}500\text{ V}$ , $I_O = 10\text{ A}$ )

### Operating data

Input voltage ranges $U_E$	AC 340...575 V
Operating voltage range $U_B$	AC 400...500 V
Effective output	240 W
Output voltage $U_O$	24 V SELV
Output current rating $I_O$	10 A
Efficiency	88 % min. / 90 % typically

### General data

Switching frequency	25 kHz
Insulation voltage between input and output	AC 3000 V, DC 4242 V
Insulation voltage between input and protective conductor	AC 1500 V, DC 2121 V
Insulation voltage between output and protective conductor	AC 500 V, DC 710 V
Insulation resistance	100 M $\Omega$ (DC 500 V) between input and output
Ambient temperature	-40°C...+71°C
Derating factor (see curve)	2.5 % / °C
Storage temperature	-40°C...+85°C
Relative humidity	20...95 % RH
MTBF to Bellcore, ed. 6	488,000 hours at 40°C, GB
Max. altitude in operation to IEC 60068-2-13	5000 m above sea level
Cooling	by convection
Mounting direction	wall-mounted (see dimensions)
Pollution degree	2

### Input circuit

Input rated voltage	three-phase or single phase* AC 400...500 V
Input voltage ranges	AC 340...575 V
Input current	0.55 A typically at $U_B = \text{AC } 500\text{ V}$ 0.65 A typically at $U_B = \text{AC } 400\text{ V}$
Max. input current	0.85 A typically at $U_B = \text{AC } 340\text{ V}$

\* with single phase supply voltage the output current is only 75% of the rated current

**Technical data ( $T_U = 25^\circ\text{C}$ ,  $U_B = \text{AC } 400\text{...}500\text{ V}$ ,  $I_0 = 10\text{ A}$ )**

Supply frequency	47...63 Hz
Inrush current at AC 380 V / 480 V	20 A typically, 25 A max.
Power loss (at $U_B$ 400 V, $I_0$ 10 A)	30 W typically
power factor compensation (passive)	typically 0.55
<b>Output circuit</b>	
Rated voltage $U_0$	DC 24 V SELV
Current rating $I_0$	10 A
Output voltage accuracy	0...+1 %
Min. load	0 %
Supply regulation	$\pm 0.5\%$ at $U_E$ min. ... $U_E$ max.
Load regulation	
Single mode	$\pm 1\%$
Parallel mode	$\pm 5\%$
Voltage adjustment range	DC 22.5 ... 28.5 V at $0.8 \times I_0$
Continuous load	10 A at $U_0 = \text{DC } 24\text{ V}$ , 8.4 A at $U_0 = \text{DC } 28.5\text{ V}$
Power boost factor	typically 130 % (120%...140% see output curve)
Short circuit behaviour	hiccup mode
Exposure time	25 / 30 ms
ON delay at:	
resistive load	1 s
capacitive load of 7,000 $\mu\text{F}$	1.5 s
Rise time at:	
resistive load	150 ms
capacitive load of 7,000 $\mu\text{F}$	0.5 s
Release time	150 ms
Residual ripple	100 mV, spectrum = 20 MHz
Power back immunity	DC 35 V min.
Capacitive load	7,000 $\mu\text{F}$ max.
Parallel mode	3 power supplies max. at $0.1 \times I_0$ ... $0.9 \times I_0$

**Technical data ( $T_U = 25^\circ\text{C}$ ,  $U_B = \text{AC } 400\text{...}500\text{ V}$ ,  $I_0 = 10\text{ A}$ )**

<b>Control and protection circuit</b>	
Input protection	internal fuse T2A / AC 600 V per phase
Recommended back-up fuse	3-pole MCB, e.g. E-T-A type 4230
Current rating	6 A / 10 A $\rightarrow$ max. 20 A
Characteristic curve	B / C / D
Internal overvoltage protection	varistor
Available power (output RDY)	Contact closed at: DC 17.6...19.4 V
Insulation voltage	DC 500 V (to output)
Contact load at	DC 60 V / 0.3 A
Overvoltage protection	30...33 V at $0.8 \times I_0$
Temperature protection:	100 $^\circ\text{C}$ ...110 $^\circ\text{C}$ measured at the heat sink, disconnection of output voltage, automatic reset after temperature reduction
Degree of protection	IP20
<b>Physical data</b>	
Dimensions (h x w x d) version with screw terminals:	124 x 89 x 118.8 mm (4.88 x 3.5 x 4.87 inches)
Housing material:	metal
Mass	approx. 1100 g
Vibrations (random vibration to IEC 60068-2-6)	mounted on symmetrical rail, 10 - 500 Hz 2 g, on X, Y & Z axis, 60 minutes per axis
Shock (to IEC 60068-2-27)	15 g (11 ms), 3 axes, 6 sides, 3 times per side

3

**Tolerances**

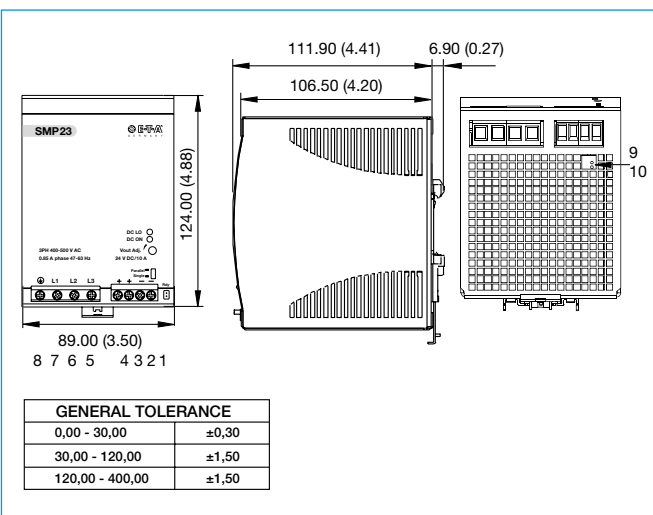

**Mounting and Installation**

Mounting	snap onto DIN rail (TS35/7.5 or TS35/15)	
Ventilation / cooling	normal air convection, recommended distance on each side 25 mm	
Mounting position	wall-mounted with input terminals pointing downwards (see dimensions)	
<b>Version with screw terminals:</b>		
Screw terminals	input terminal AWG24-10 (0.2 mm <sup>2</sup> – 4 mm <sup>2</sup> ) flexible/rigid output terminal AWG24-10 (0.2 mm <sup>2</sup> – 4 mm <sup>2</sup> ) flexible/rigid	
Tightening torque	input connector	1 Nm max.
	Output terminal	0.6 Nm max.
Wire stripping length	8 mm	

**Pin assignment - Display - Controls**

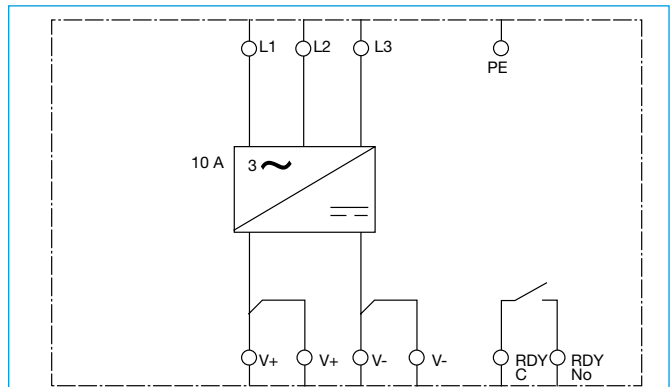

pin no.	name	Description	
1.2	V -	output voltage -	
3.4	V +	output voltage +	
5	L3	input voltage, phase conductor	
6	L2	input voltage, phase conductor	
7	L1	input voltage, phase conductor	
8	PE	earth conductor	
9	RDY	limit value DC ON, relay contact (make contact)	
10		DC ON	visual status indication with LED
		DC LO	DC LOW output voltage LED indication
		Vout Adj	potentiometer for adjustment of the output voltage $U_o$
		S/P	change-over switch single / parallel mode

3

**Schematic diagram**

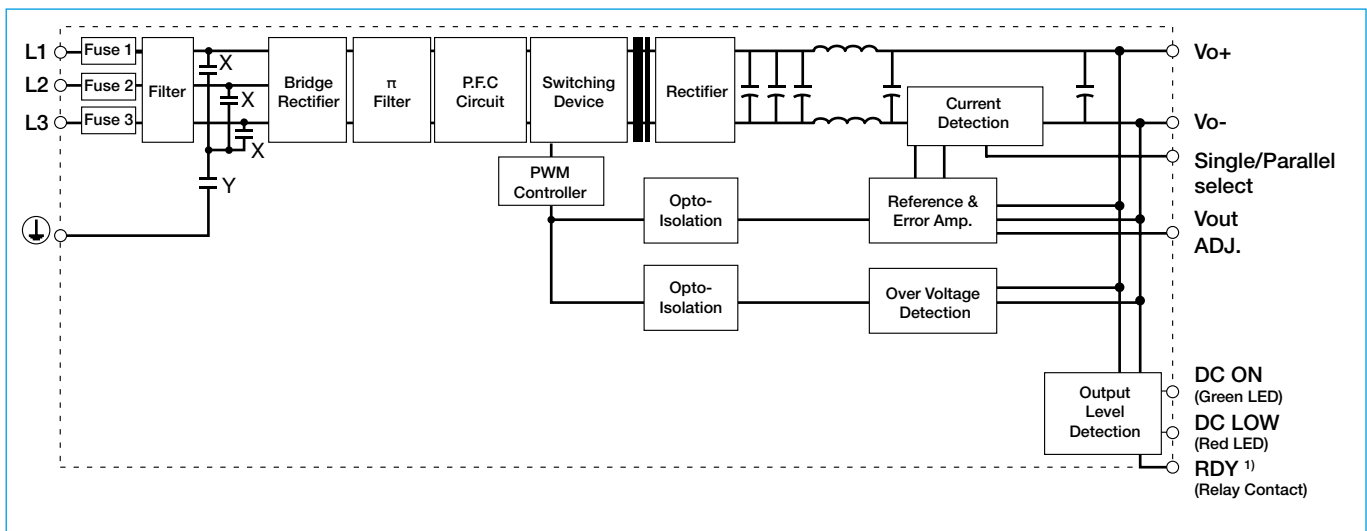

**Typical output trip curve**

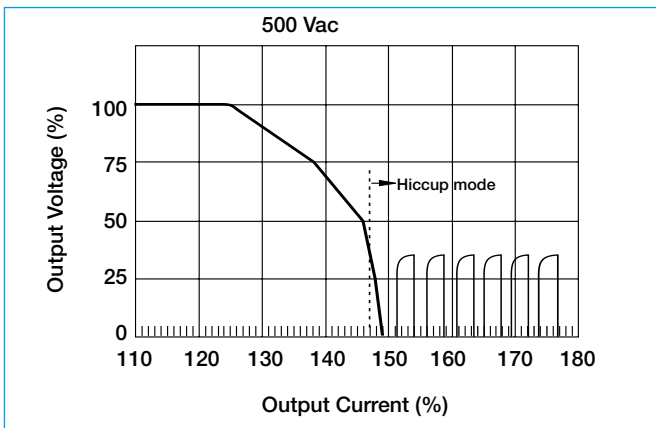
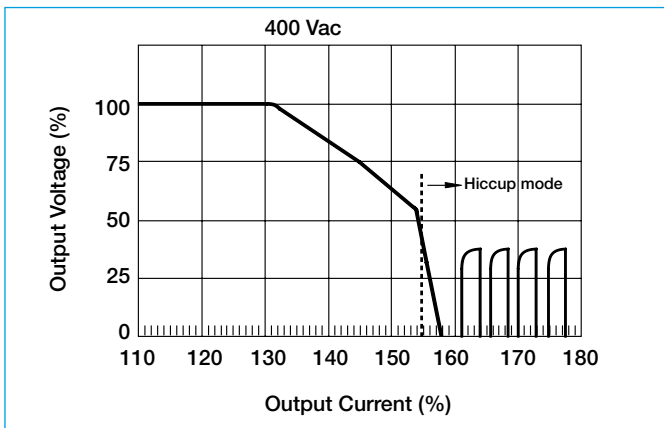

**Derating curve**

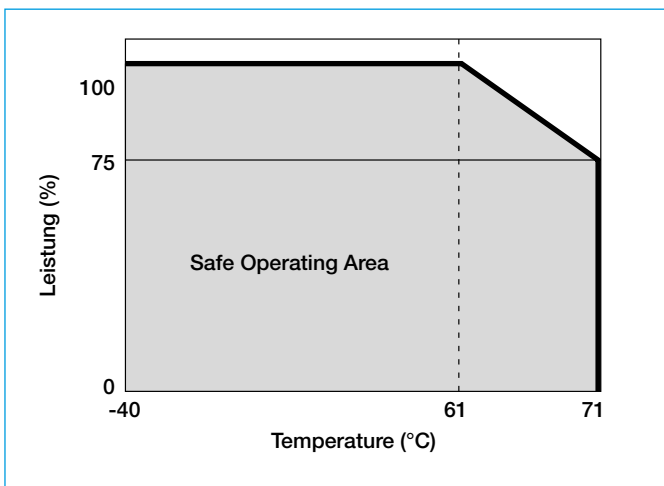

**Typical efficiency curve**

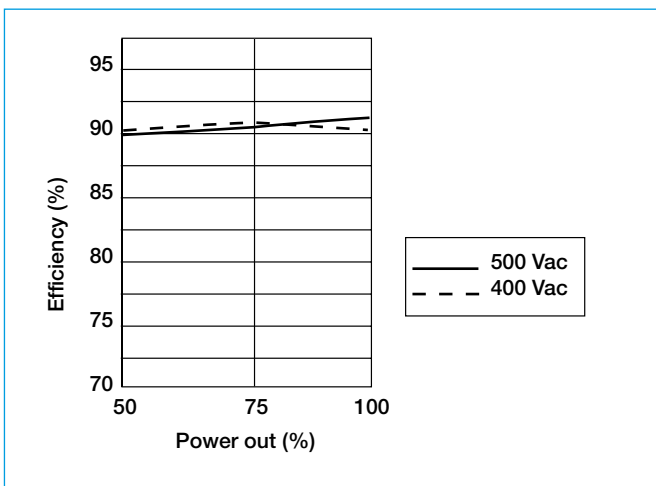

**Current-voltage curve**

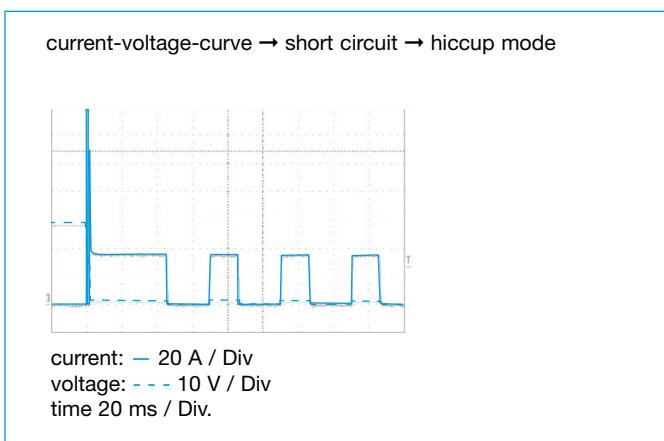

**Current-voltage curve**

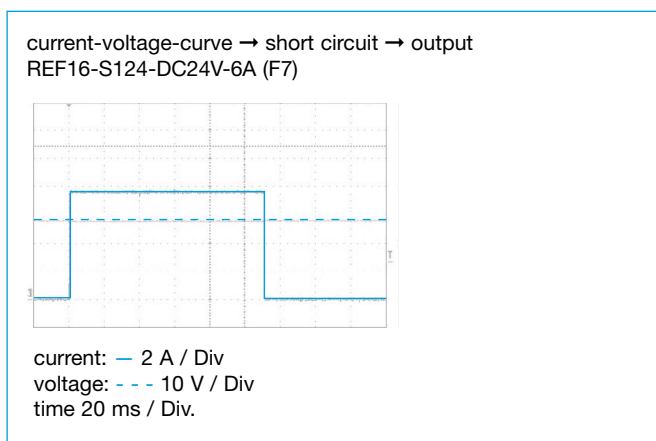

3

Application example with protection by 4230-T and REF16-S

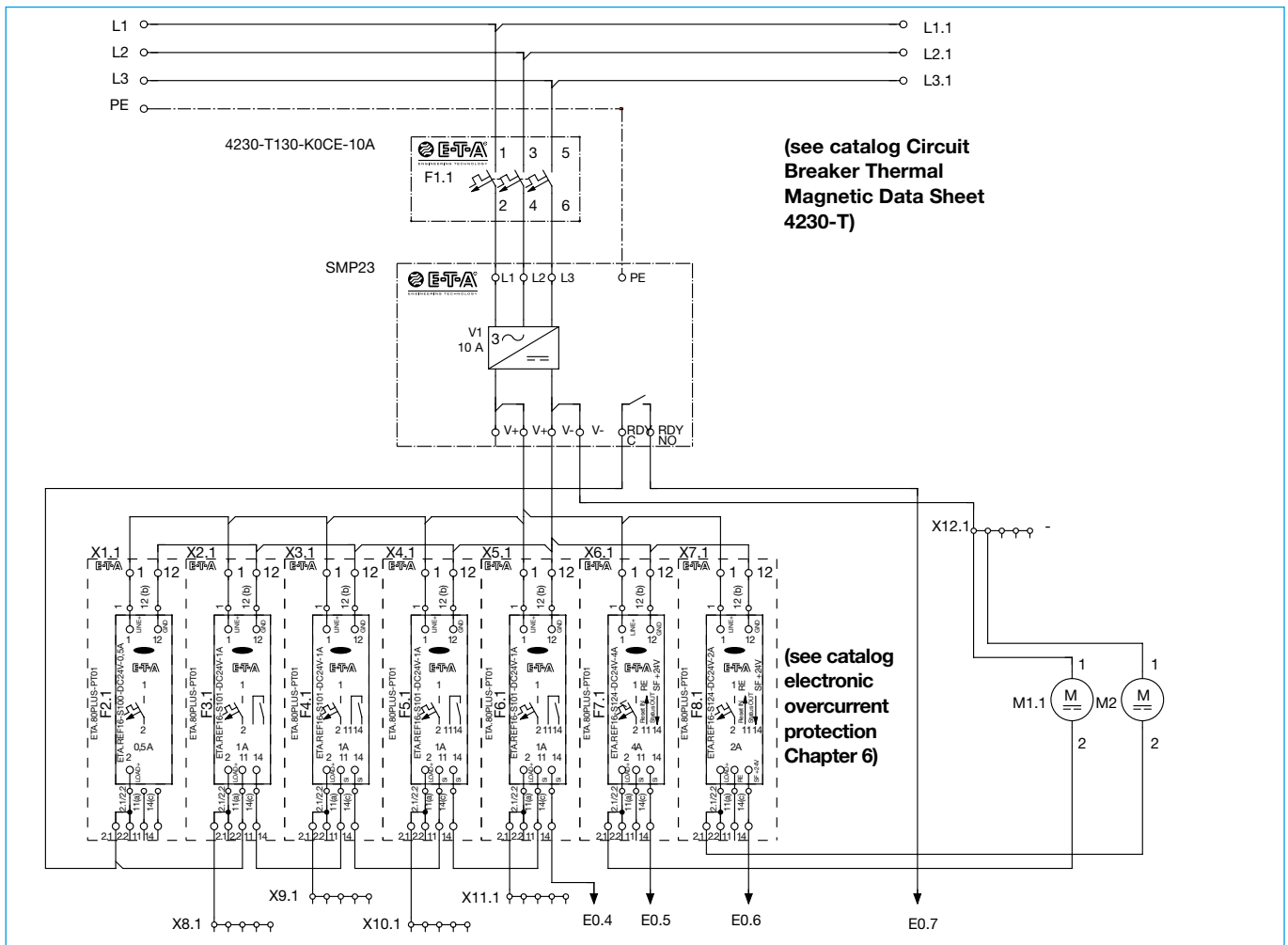

Notes for installation

- The power distribution system must only be installed by qualified personnel.
- Only after expert installation must the device be supplied with power.
- The user has to ensure that the cable cross section complies with the applicable current rating.
- The national standards (e.g. for Germany DIN VDE 0100) have to be observed for installation and selection of feed and return cables.
- Recommended circuit breaker for the primary input cable protection: E-T-A type 4230 IN max. 20 A
- Recommended selective overcurrent protection for the secondary output protection: E-T-A types ESS..., ESX..., und REF...
- In addition special precautions must be taken in the system or machine (e.g. use of a safety PLC) which reliably prevent an automatic re-start of parts of the system (cf. Machinery Directive 2006/42/EU and EN 60204-1, Safety of Machinery). In the event of a failure (short circuit/overload) the load circuit will be disconnected by the circuit breaker/protector or the switched mode power supply.

3

All dimensions without tolerances are for reference only. E-T-A reserves the right change specifications at any time in the interest of improved design, performance and cost effectiveness, the right to make changes in these specifications without notice is reserved. Product markings may not be exactly as the ordering codes. Errors and omissions excepted.