



Chipsmall Limited consists of a professional team with an average of over 10 year of expertise in the distribution of electronic components. Based in Hongkong, we have already established firm and mutual-benefit business relationships with customers from,Europe,America and south Asia,supplying obsolete and hard-to-find components to meet their specific needs.

With the principle of "Quality Parts,Customers Priority,Honest Operation,and Considerate Service",our business mainly focus on the distribution of electronic components. Line cards we deal with include Microchip,ALPS,ROHM,Xilinx,Pulse,ON,Everlight and Freescale. Main products comprise IC,Modules,Potentiometer,IC Socket,Relay,Connector.Our parts cover such applications as commercial,industrial, and automotives areas.

We are looking forward to setting up business relationship with you and hope to provide you with the best service and solution. Let us make a better world for our industry!



Contact us

Tel: +86-755-8981 8866 Fax: +86-755-8427 6832

Email & Skype: info@chipsmall.com Web: www.chipsmall.com

Address: A1208, Overseas Decoration Building, #122 Zhenhua RD., Futian, Shenzhen, China



- NOTES:
- ASSURE ASSEMBLY CAPABILITY BY MATCHING WITH MATING PART
 - DIMENSIONS IN [] ARE IN MILLIMETERS

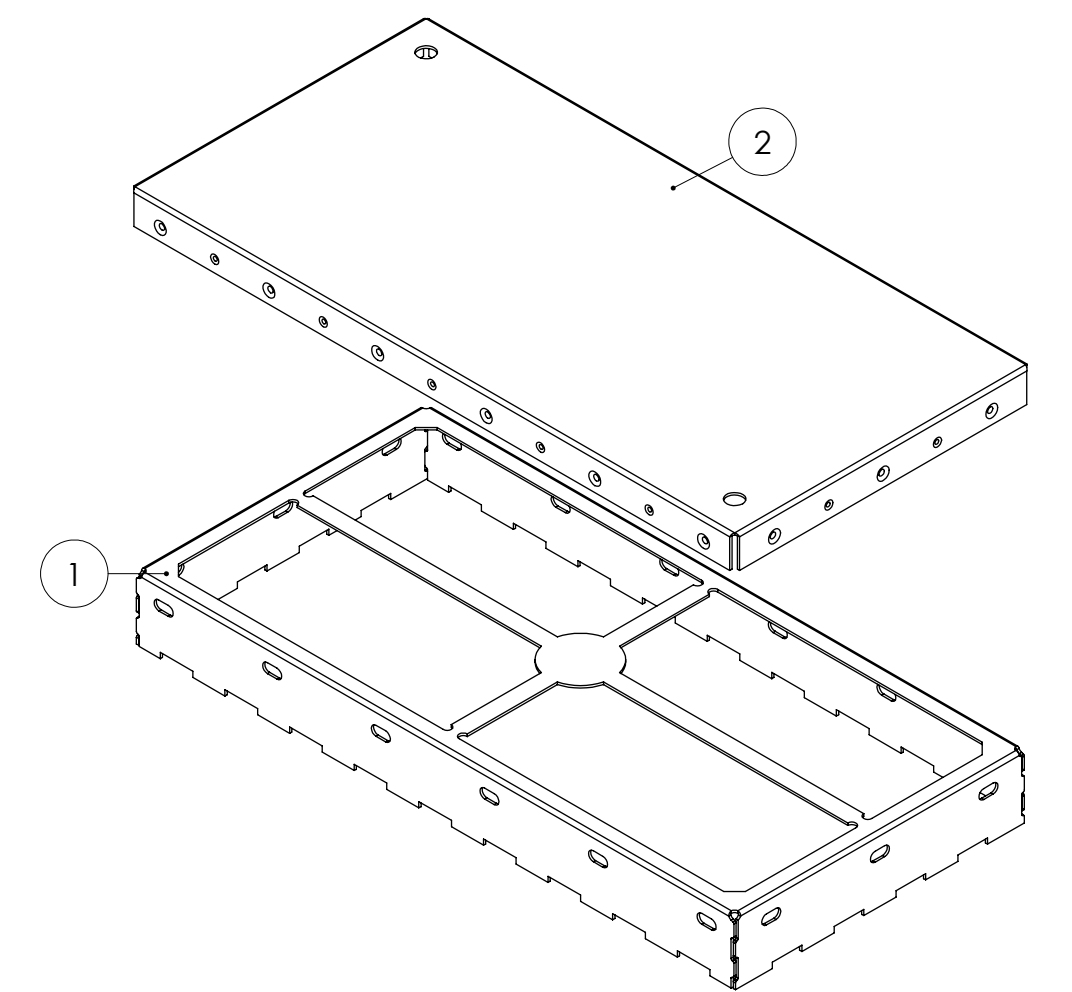
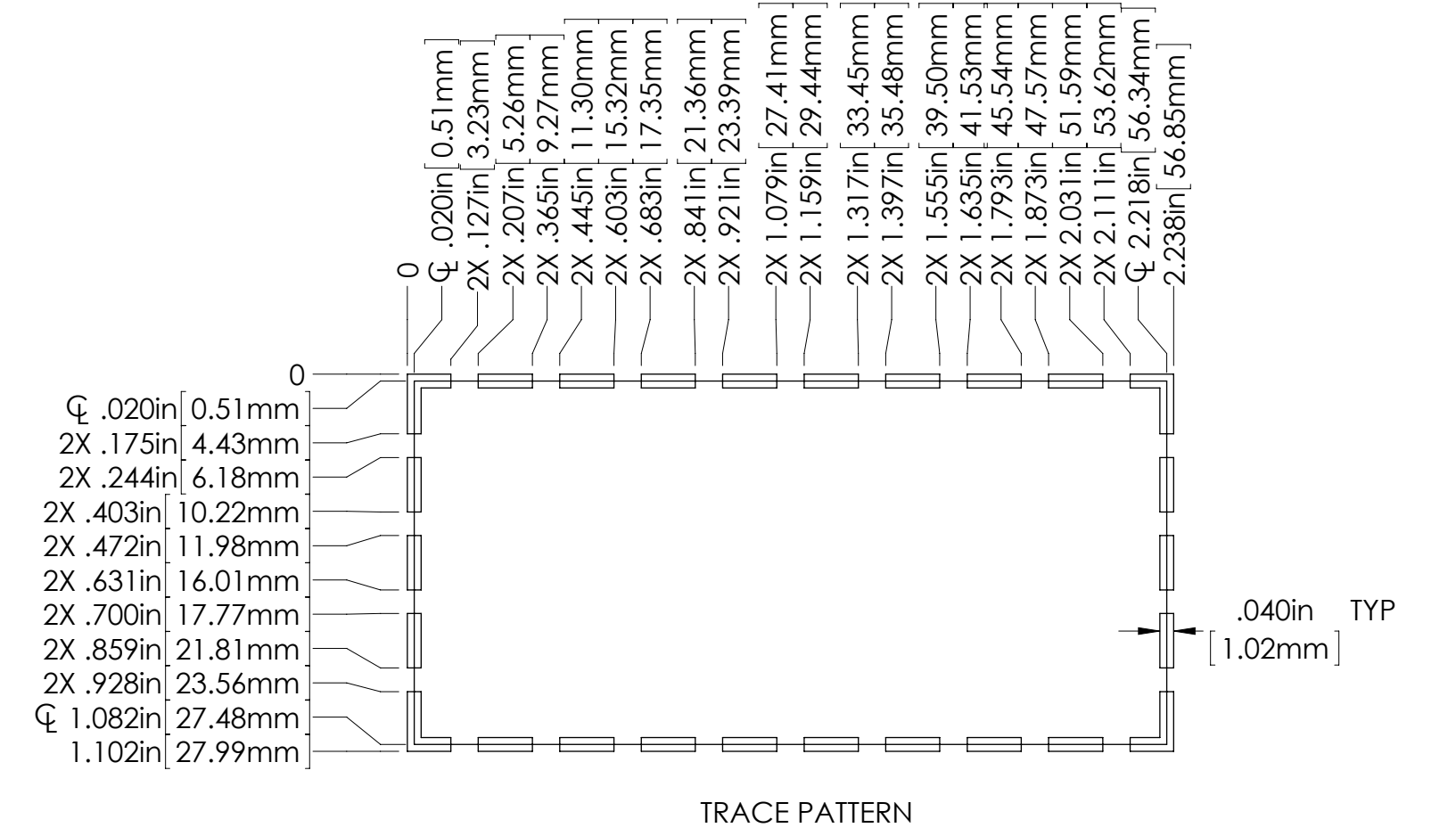
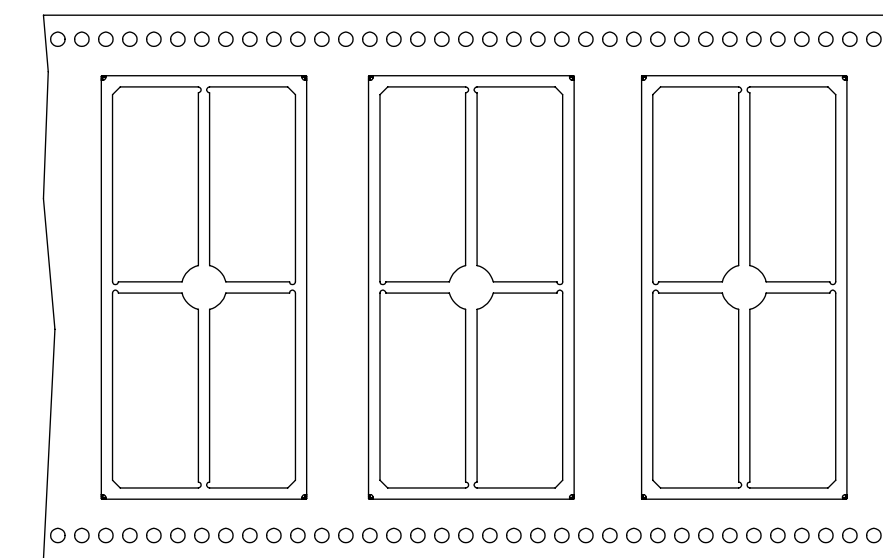
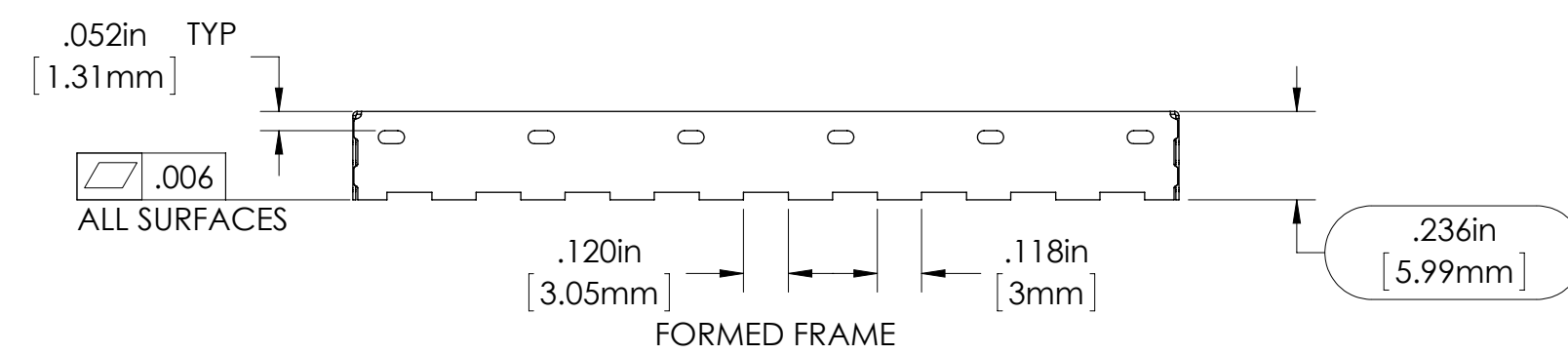
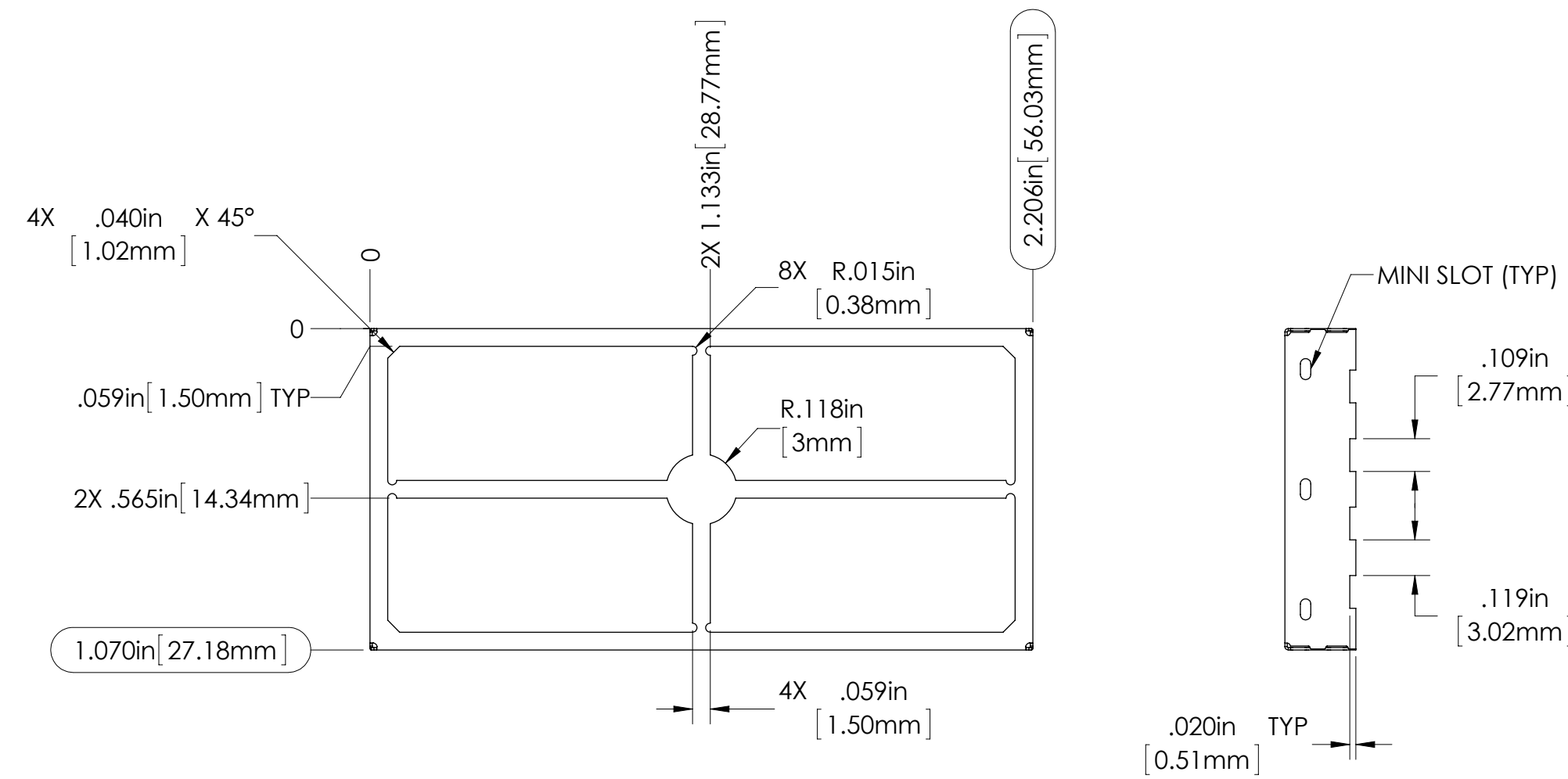
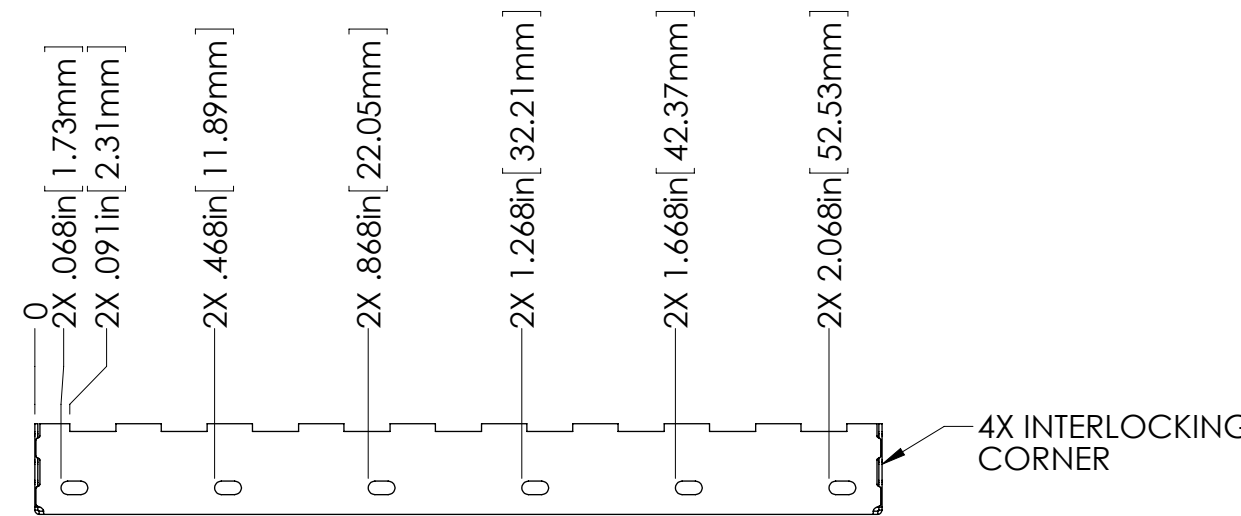
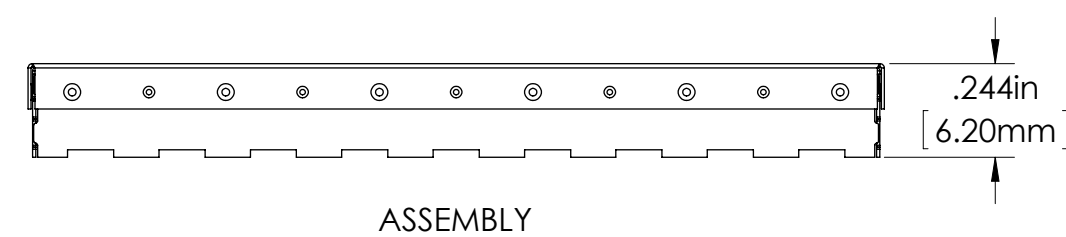
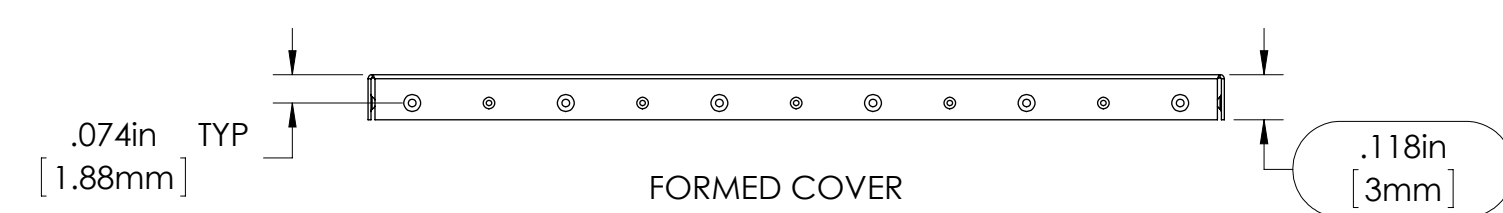
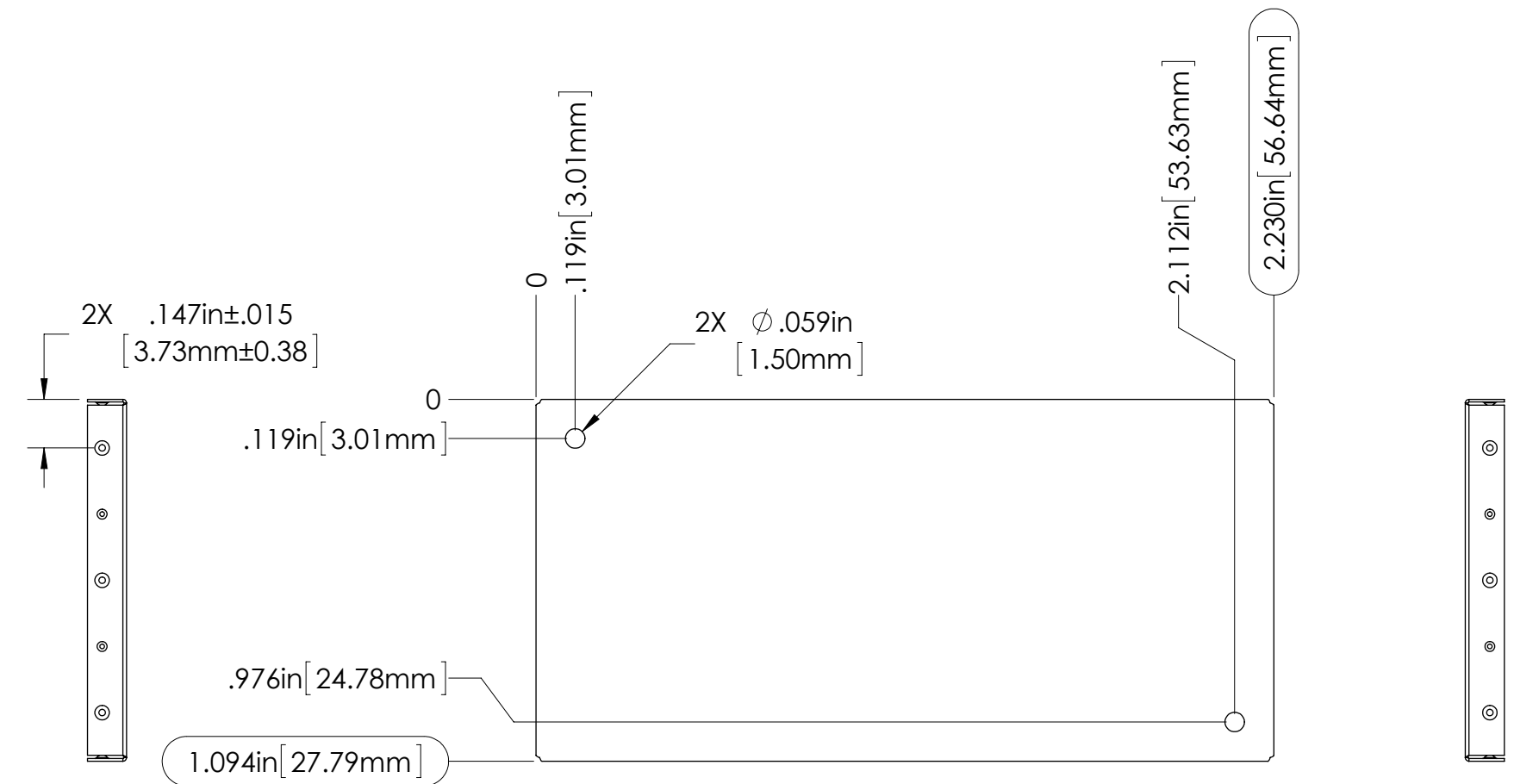
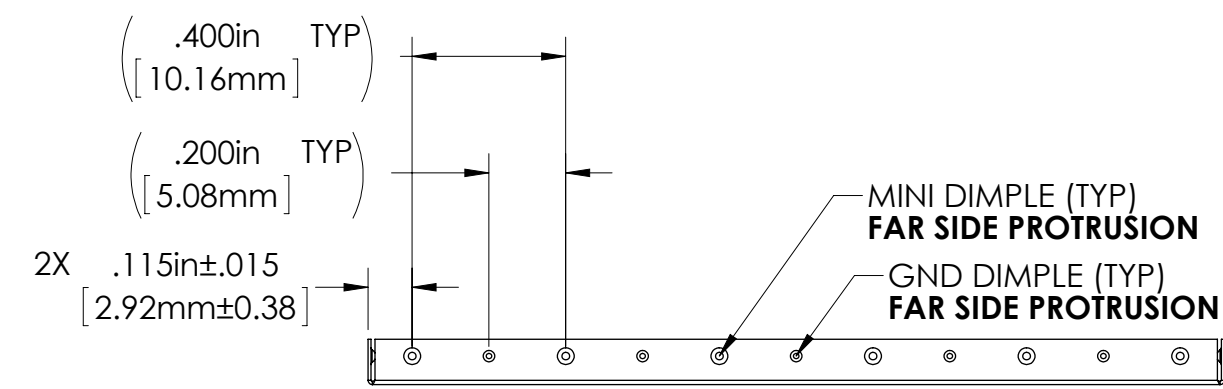

CARRIER TAPE SPECIFICATIONS						
PART NUMBER	DESCRIPTION	OVERALL DIMENSIONS	OVERALL HEIGHT	CARRIER TAPE WIDTH	CARRIER TAPE PITCH	PARTS PER REEL
SMS-461F	FRAME	1.070 X 2.206 [27.18 X 56.03]	.236 [5.99]	72 mm	40 mm	200
SMS-461C	COVER	1.094 X 2.230 [27.79 X 56.64]	.118 [3.00]	N/A	N/A	BULK PACK

THIS DOCUMENT CONTAINS PROPRIETARY INFORMATION OWNED BY LEADERTECH, OR DEVELOPED AT ITS OWN PRIVATE EXPENSE AND MAY NOT BE USED, REPRODUCED, OR DISCLOSED IN WHOLE OR IN PART FOR ANY PURPOSE INCLUDING DESIGN, MANUFACTURE OR PROCUREMENT WITHOUT THE WRITTEN PERMISSION OF LEADERTECH. LEADERTECH DOES NOT GUARANTEE OR WARRANT THE PERFORMANCE CHARACTERISTICS.

ITEM NO.	PART NUMBER	DESCRIPTION	QTY.
1	SMS-461F	FRAME	1
2	SMS-461C	COVER	1

UNLESS OTHERWISE SPECIFIED:
 - ALL DIMENSIONS ARE IN INCHES
 - PART SHALL BE FREE OF BURRS AND SHARP EDGES
 - ALL DIMENSIONS SHOWN APPLY AFTER PLATING AND COATINGS
 - ROHS COMPLIANT PER EU DIRECTIVE 2011/65/EU
 - POI = POINT OF INTERSECTION

.XXX +/- .005 .XX +/- .010 .X +/- .020 ANGLES +/- 2°
 DRAWN BY: JG 2015-10-30 APPROVED BY:

THIRD ANGLE PROJECTION
 LEADER TECH
 a HEICO company
 The Leading Edge in PMP Manufacturing Technology

TITLE: SURFACE MOUNT SHIELD
 SCALE: 2:1 DWG. NO.: D CAGE CODE: 4J674 SHEET: 1 OF 1
 MATERIAL: MATTE 0.0008" [0.20] PRE TIN STEEL