



Chipsmall Limited consists of a professional team with an average of over 10 year of expertise in the distribution of electronic components. Based in Hongkong, we have already established firm and mutual-benefit business relationships with customers from,Europe,America and south Asia,supplying obsolete and hard-to-find components to meet their specific needs.

With the principle of “Quality Parts,Customers Priority,Honest Operation,and Considerate Service”,our business mainly focus on the distribution of electronic components. Line cards we deal with include Microchip,ALPS,ROHM,Xilinx,Pulse,ON,Everlight and Freescale. Main products comprise IC,Modules,Potentiometer,IC Socket,Relay,Connector.Our parts cover such applications as commercial,industrial, and automotives areas.

We are looking forward to setting up business relationship with you and hope to provide you with the best service and solution. Let us make a better world for our industry!



Contact us

Tel: +86-755-8981 8866 Fax: +86-755-8427 6832

Email & Skype: info@chipsmall.com Web: www.chipsmall.com

Address: A1208, Overseas Decoration Building, #122 Zhenhua RD., Futian, Shenzhen, China



SMS05C, SMS12C, SMS15C, SMS24C

5-Line Transient Voltage Suppressor Array

This 5-line voltage transient suppressor array is designed for application requiring transient voltage protection capability. It is intended for use in over-transient voltage and ESD sensitive equipment such as computers, printers, automotive electronics, networking communication and other applications. This device features a monolithic common anode design which protects five independent lines in a single SC-74 package.

Features

- Protects up to 5 Lines in a Single SC-74 Package
- Peak Power Dissipation – 350 W (8 × 20 μs Waveform)
- ESD Rating of Class 3B (Exceeding 8.0 kV) per Human Body Model and Class C (Exceeding 400 V) per Machine Model
- Compliance with IEC 61000-4-2 (ESD) 15 kV (Air), 8.0 kV (Contact)
- Flammability Rating of UL 94 V-0
- Pb-Free Package is Available

Applications

- Hand-Held Portable Applications
- Networking and Telecom
- Automotive Electronics
- Serial and Parallel Ports
- Notebooks, Desktops, Servers

MAXIMUM RATINGS (T_J = 25°C unless otherwise specified)

Symbol	Rating	Value	Unit
P _{PK} 1	Peak Power Dissipation 8 × 20 μs Double Exponential Waveform (Note 1)	350	W
T _J	Operating Junction Temperature Range	-40 to 125	°C
T _{STG}	Storage Temperature Range	-55 to 150	°C
T _L	Lead Solder Temperature (10 s)	260	°C
ESD	Human Body Model (HBM) Machine Model (MM) IEC 61000-4-2 Air (ESD) IEC 61000-4-2 Contact (ESD)	>8000 >400 >15000 >8000	V

Maximum ratings are those values beyond which device damage can occur. Maximum ratings applied to the device are individual stress limit values (not normal operating conditions) and are not valid simultaneously. If these limits are exceeded, device functional operation is not implied, damage may occur and reliability may be affected.

1. Non-repetitive current pulse per Figure 3.



ON Semiconductor®

<http://onsemi.com>

SC-74 FIVE TRANSIENT VOLTAGE SUPPRESSOR 350 W PEAK POWER

PIN ASSIGNMENT

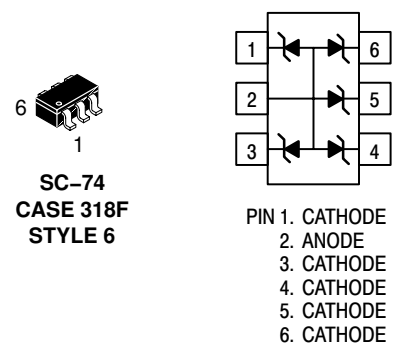

MARKING DIAGRAM

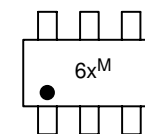

x = SMS05C:J
= SMS12C:K
= SMS15C:L
= SMS24C:M
M = Date Code

ORDERING INFORMATION

Device	Package	Shipping†
SMS05CT1	SC-74	3000/Tape & Reel
SMS12CT1	SC-74	3000/Tape & Reel
SMS15CT1	SC-74	3000/Tape & Reel
SMS15CT1G	SC-74 (Pb-Free)	3000/Tape & Reel
SMS24CT1	SC-74	3000/Tape & Reel

†For information on tape and reel specifications, including part orientation and tape sizes, please refer to our Tape and Reel Packaging Specification Brochure, BRD8011/D.

SMS05C, SMS12C, SMS15C, SMS24C

SMS05C ELECTRICAL CHARACTERISTICS ($T_J = 25^\circ\text{C}$ unless otherwise specified)

Parameter	Symbol	Conditions	Min	Typ	Max	Unit
Reverse Working Voltage	V_{RWM}	(Note 2)			5.0	V
Breakdown Voltage	V_{BR}	$I_T = 1.0\text{ mA}$ (Note 3)	6.2		7.2	V
Reverse Leakage Current	I_R	$V_{RWM} = 5.0\text{ V}$			5.0	μA
Clamping Voltage	V_C	$I_{PP} = 5.0\text{ A}$ ($8 \times 20\ \mu\text{s}$ Waveform)			9.8	V
Clamping Voltage	V_C	$I_{PP} = 24\text{ A}$ ($8 \times 20\ \mu\text{s}$ Waveform)			14.5	V
Maximum Peak Pulse Current	I_{PP}	$8 \times 20\ \mu\text{s}$ Waveform			24	A
Capacitance	C_J	$V_R = 0\text{ V}$, $f = 1.0\text{ MHz}$ (Line to GND)		260	400	pF

SMS12C ELECTRICAL CHARACTERISTICS ($T_J = 25^\circ\text{C}$ unless otherwise specified)

Parameter	Symbol	Conditions	Min	Typ	Max	Unit
Reverse Working Voltage	V_{RWM}	(Note 2)			12	V
Breakdown Voltage	V_{BR}	$I_T = 1.0\text{ mA}$ (Note 3)	13.3		15	V
Reverse Leakage Current	I_R	$V_{RWM} = 12\text{ V}$		0.001	1.0	μA
Clamping Voltage	V_C	$I_{PP} = 5.0\text{ A}$ ($8 \times 20\ \mu\text{s}$ Waveform)			19	V
Clamping Voltage	V_C	$I_{PP} = 15\text{ A}$ ($8 \times 20\ \mu\text{s}$ Waveform)			23	V
Maximum Peak Pulse Current	I_{PP}	$8 \times 20\ \mu\text{s}$ Waveform			15	A
Capacitance	C_J	$V_R = 0\text{ V}$, $f = 1.0\text{ MHz}$ (Line to GND)		120	150	pF

SMS15C ELECTRICAL CHARACTERISTICS ($T_J = 25^\circ\text{C}$, unless otherwise specified) (See Note 4)

Parameter	Symbol	Conditions	Min	Typ	Max	Unit
Reverse Working Voltage	V_{RWM}	(Note 2)			15	V
Breakdown Voltage	V_{BR}	$I_T = 1.0\text{ mA}$ (Note 3)	17		19	V
Reverse Leakage Current	I_R	$V_{RWM} = 15\text{ V}$		0.05	1.0	μA
Clamping Voltage	V_C	$I_{PP} = 5.0\text{ A}$ ($8 \times 20\ \mu\text{s}$ Waveform)			24	V
Clamping Voltage	V_C	$I_{PP} = 12\text{ A}$ ($8 \times 20\ \mu\text{s}$ Waveform)			29	V
Maximum Peak Pulse Current	I_{PP}	$8 \times 20\ \mu\text{s}$ Waveform			12	A
Capacitance	C_J	$V_R = 0\text{ V}$, $f = 1.0\text{ MHz}$ (Line to GND)		95	125	pF

SMS24C ELECTRICAL CHARACTERISTICS ($T_J = 25^\circ\text{C}$, unless otherwise specified)

Parameter	Symbol	Conditions	Min	Typ	Max	Unit
Reverse Working Voltage	V_{RWM}	(Note 2)			24	V
Breakdown Voltage	V_{BR}	$I_T = 1.0\text{ mA}$ (Note 3)	26.7		32	V
Reverse Leakage Current	I_R	$V_{RWM} = 24\text{ V}$		0.001	1.0	μA
Clamping Voltage	V_C	$I_{PP} = 5.0\text{ A}$ ($8 \times 20\ \mu\text{s}$ Waveform)			40	V
Clamping Voltage	V_C	$I_{PP} = 8\text{ A}$ ($8 \times 20\ \mu\text{s}$ Waveform)			44	V
Maximum Peak Pulse Current	I_{PP}	$8 \times 20\ \mu\text{s}$ Waveform			8.0	A
Capacitance	C_J	$V_R = 0\text{ V}$, $f = 1.0\text{ MHz}$ (Line to GND)		60	75	pF

2. TVS devices are normally selected according to the working peak reverse voltage (V_{RWM}), which should be equal or greater than the DC or continuous peak operating voltage level.
3. V_{BR} is measured at pulse test current I_T .
4. Parametrics are the same for the Pb-Free packages, which are suffixed with a "G".

SMS05C, SMS12C, SMS15C, SMS24C

TYPICAL PERFORMANCE CURVES ($T_J = 25^\circ\text{C}$ unless otherwise specified)

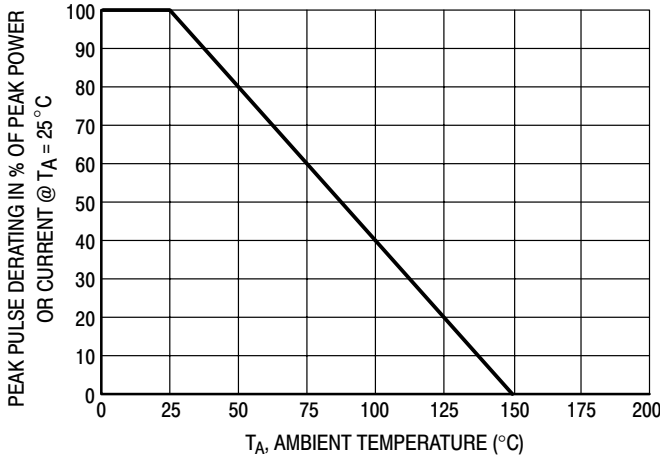

Figure 1. Pulse Derating Curve

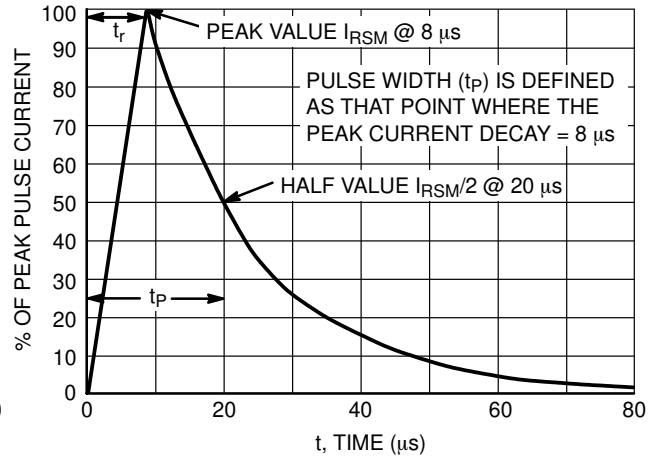

Figure 2. $8 \times 20 \mu\text{s}$ Pulse Waveform

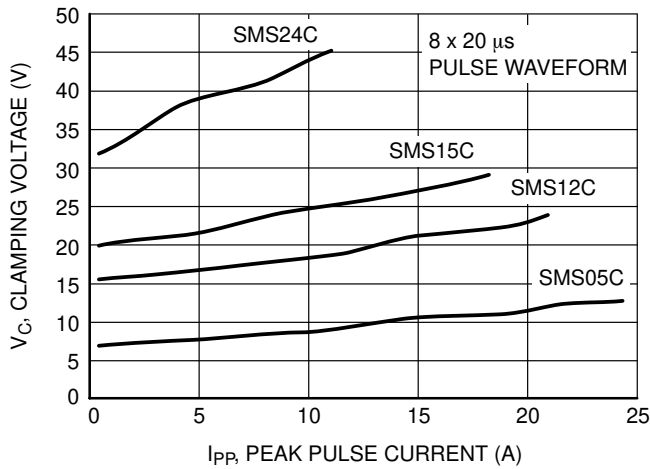

Figure 3. Clamping Voltage vs. Peak Pulse Current

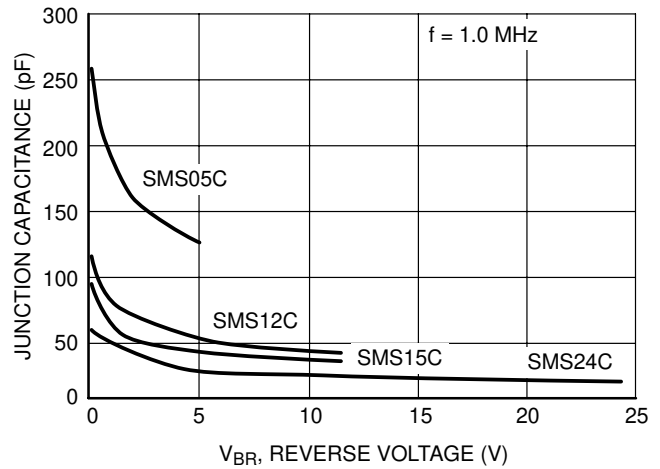

Figure 4. Junction Capacitance vs. Reverse Voltage

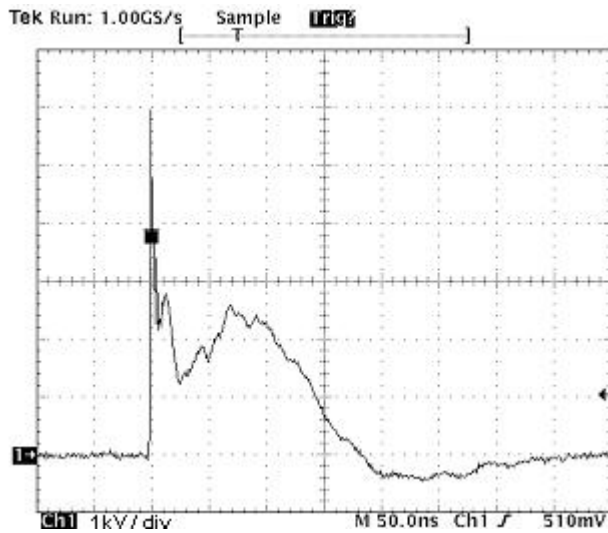

Figure 5. ESD Pulse IEC 61000-4-2 (8.0 kV Contact)

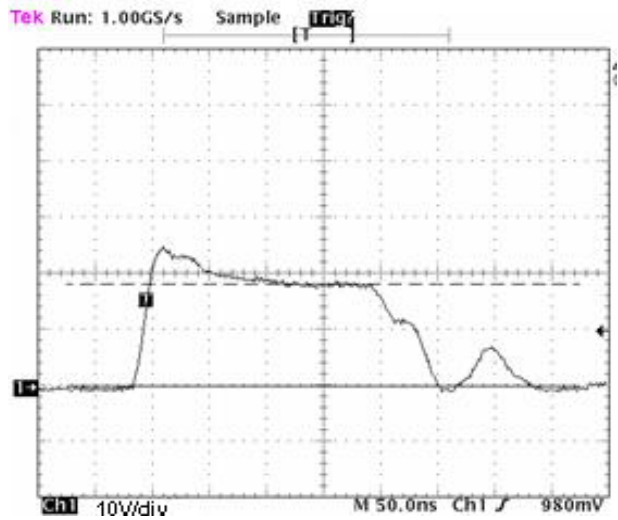

Figure 6. SMS15CT1 ESD Response for IEC 61000-4-2 (+8.0 kV Contact)

SMS05C, SMS12C, SMS15C, SMS24C

TYPICAL COMMON ANODE APPLICATIONS

A 5 TVS junction common anode design in a SC-74 package protects four separate lines using only one package. This adds flexibility and creativity to PCB design especially

when board space is at a premium. A simplified example of SMS05C Series Device applications is illustrated below.

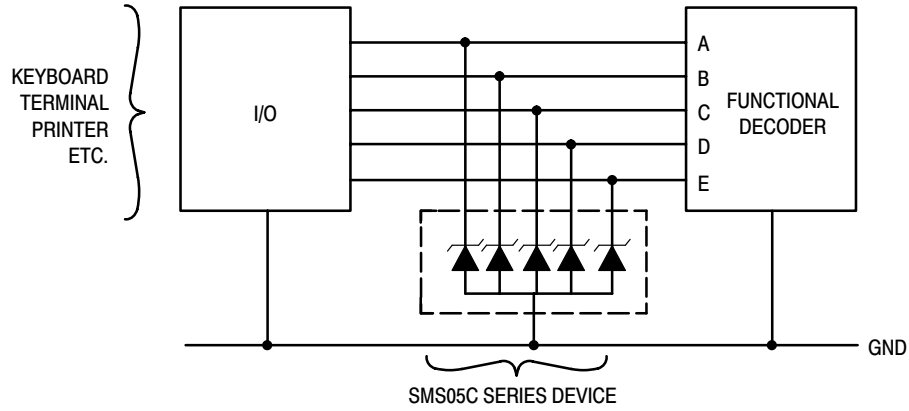

Figure 7. Computer Interface Protection

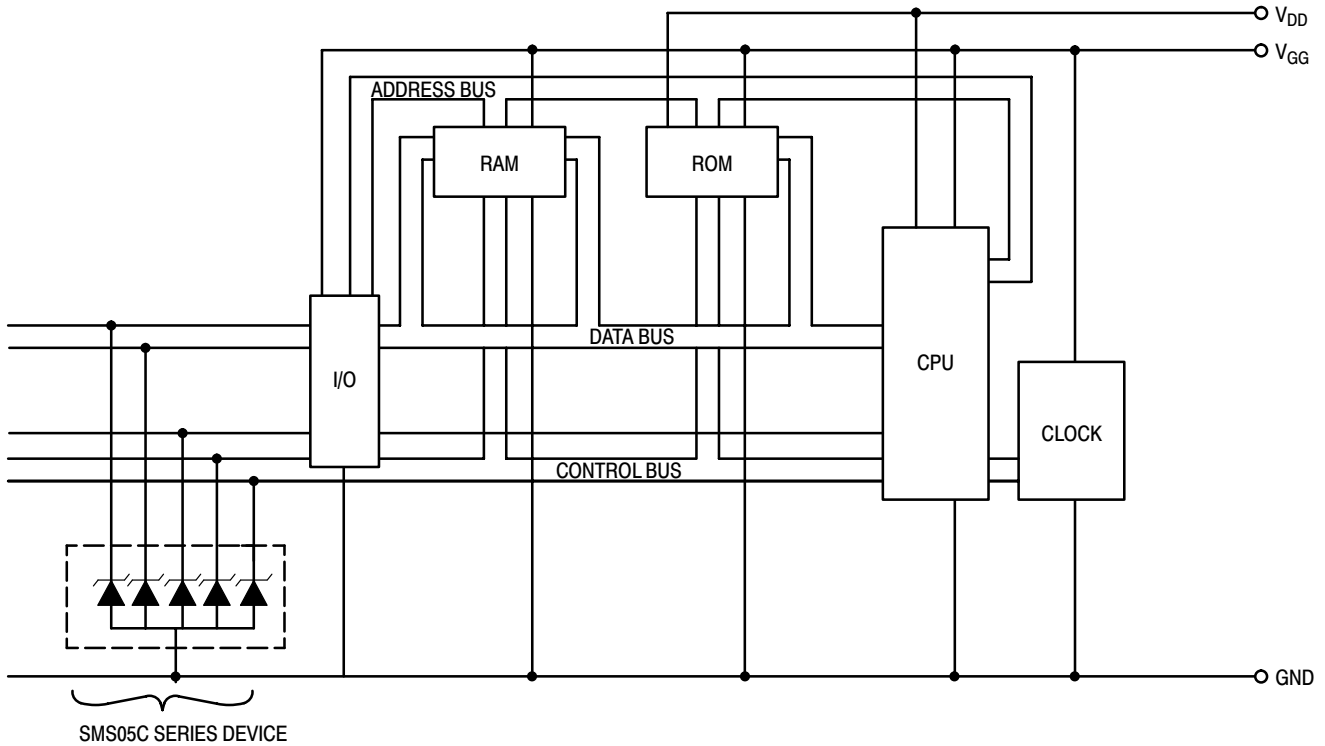
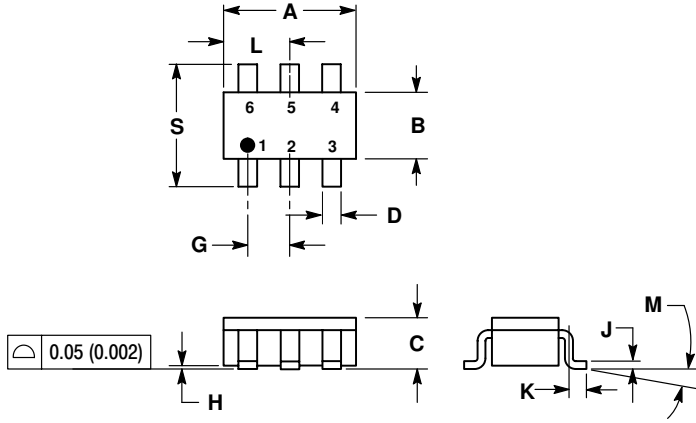

Figure 8. Microprocessor Protection

SMS05C, SMS12C, SMS15C, SMS24C

PACKAGE DIMENSIONS

SC-74
CASE 318F-05
ISSUE K



NOTES:

1. DIMENSIONING AND TOLERANCING PER ANSI Y14.5M, 1982.
2. CONTROLLING DIMENSION: INCH.
3. MAXIMUM LEAD THICKNESS INCLUDES LEAD FINISH THICKNESS. MINIMUM LEAD THICKNESS IS THE MINIMUM THICKNESS OF BASE MATERIAL.

DIM	INCHES		MILLIMETERS	
	MIN	MAX	MIN	MAX
A	0.1142	0.1220	2.90	3.10
B	0.0512	0.0669	1.30	1.70
C	0.0354	0.0433	0.90	1.10
D	0.0098	0.0197	0.25	0.50
G	0.0335	0.0413	0.85	1.05
H	0.0005	0.0040	0.013	0.100
J	0.0040	0.0102	0.10	0.26
K	0.0079	0.0236	0.20	0.60
L	0.0493	0.0649	1.25	1.65
M	0°	10°	0°	10°
S	0.0985	0.1181	2.50	3.00

STYLE 6:

- PIN 1. CATHODE
- ANODE
- CATHODE
- CATHODE
- CATHODE
- CATHODE

SOLDERING FOOTPRINT*

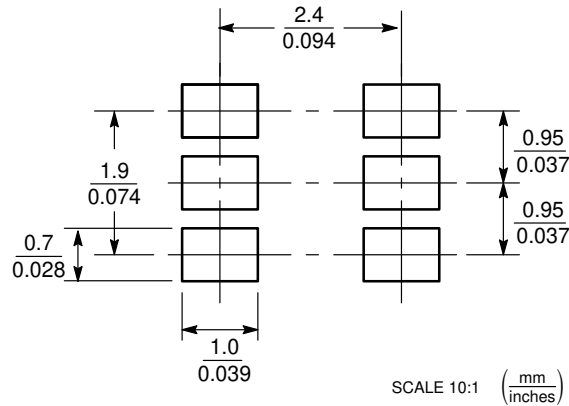

*For additional information on our Pb-Free strategy and soldering details, please download the ON Semiconductor Soldering and Mounting Techniques Reference Manual, SOLDERRM/D.

SMS05C, SMS12C, SMS15C, SMS24C

ON Semiconductor and  are registered trademarks of Semiconductor Components Industries, LLC (SCILLC). SCILLC reserves the right to make changes without further notice to any products herein. SCILLC makes no warranty, representation or guarantee regarding the suitability of its products for any particular purpose, nor does SCILLC assume any liability arising out of the application or use of any product or circuit, and specifically disclaims any and all liability, including without limitation special, consequential or incidental damages. "Typical" parameters which may be provided in SCILLC data sheets and/or specifications can and do vary in different applications and actual performance may vary over time. All operating parameters, including "Typicals" must be validated for each customer application by customer's technical experts. SCILLC does not convey any license under its patent rights nor the rights of others. SCILLC products are not designed, intended, or authorized for use as components in systems intended for surgical implant into the body, or other applications intended to support or sustain life, or for any other application in which the failure of the SCILLC product could create a situation where personal injury or death may occur. Should Buyer purchase or use SCILLC products for any such unintended or unauthorized application, Buyer shall indemnify and hold SCILLC and its officers, employees, subsidiaries, affiliates, and distributors harmless against all claims, costs, damages, and expenses, and reasonable attorney fees arising out of, directly or indirectly, any claim of personal injury or death associated with such unintended or unauthorized use, even if such claim alleges that SCILLC was negligent regarding the design or manufacture of the part. SCILLC is an Equal Opportunity/Affirmative Action Employer. This literature is subject to all applicable copyright laws and is not for resale in any manner.

PUBLICATION ORDERING INFORMATION

LITERATURE FULFILLMENT:

Literature Distribution Center for ON Semiconductor
P.O. Box 61312, Phoenix, Arizona 85082-1312 USA
Phone: 480-829-7710 or 800-344-3860 Toll Free USA/Canada
Fax: 480-829-7709 or 800-344-3867 Toll Free USA/Canada
Email: orderlit@onsemi.com

N. American Technical Support: 800-282-9855 Toll Free
USA/Canada

Japan: ON Semiconductor, Japan Customer Focus Center
2-9-1 Kamimeguro, Meguro-ku, Tokyo, Japan 153-0051
Phone: 81-3-5773-3850

ON Semiconductor Website: <http://onsemi.com>

Order Literature: <http://www.onsemi.com/litorder>

For additional information, please contact your
local Sales Representative.