



Chipsmall Limited consists of a professional team with an average of over 10 year of expertise in the distribution of electronic components. Based in Hongkong, we have already established firm and mutual-benefit business relationships with customers from,Europe,America and south Asia,supplying obsolete and hard-to-find components to meet their specific needs.

With the principle of “Quality Parts,Customers Priority,Honest Operation,and Considerate Service”,our business mainly focus on the distribution of electronic components. Line cards we deal with include Microchip,ALPS,ROHM,Xilinx,Pulse,ON,Everlight and Freescale. Main products comprise IC,Modules,Potentiometer,IC Socket,Relay,Connector.Our parts cover such applications as commercial,industrial, and automotives areas.

We are looking forward to setting up business relationship with you and hope to provide you with the best service and solution. Let us make a better world for our industry!



## Contact us

Tel: +86-755-8981 8866 Fax: +86-755-8427 6832

Email & Skype: info@chipsmall.com Web: www.chipsmall.com

Address: A1208, Overseas Decoration Building, #122 Zhenhua RD., Futian, Shenzhen, China



**DATA SHEET**

# SMV1265 Series Hyperabrupt Junction Tuning Varactors

## Applications

- Wideband RF and microwave VCOs
- Analog phase shifters
- Digital TV tuners

## Features

- High tuning ratio
- Low series resistance
- Designed for high volume, low-cost applications
- Small footprint packages (MSL1, 260 °C per JEDEC J-STD-020)





Skyworks Green™ products are compliant with all applicable legislation and are halogen-free. For additional information, refer to *Skyworks Definition of Green™*, document number SQ04-0074.

## Description

The SMV1265 series of hyperabrupt junction tuning varactors are designed for very high capacitance tuning ratios with low series resistance, which makes these devices especially attractive for wideband Voltage Controlled Oscillator (VCO) applications.

The packaging options are defined in Table 1. The absolute maximum ratings of the SMV1265 varactor series are provided in Table 2. Electrical specifications are specified in Table 3. Figure 1 shows the typical performance of capacitance versus voltage. The SPICE model for the SMV1265 series is shown in Figure 2 and the associated model parameters are provided in Table 4. The relationship between voltage and capacitance for the SMV1265 series is shown in Table 5.

**Table 1. Packaging and Marking**

	
Single	Single
SOD-323 Green™	SOD-882 Green™
<b>SMV1265-011LF</b> Marking: HM	<b>SMV1265-040LF</b> Marking: HD1
Ls = 1.7 nH	Ls = 0.45 nH



The Pb-free symbol or "LF" in the part number denotes a lead-free, RoHS-compliant package unless otherwise noted as Green™. Tin/lead (Sn/Pb) packaging is not recommended for new designs.

**Table 2. SMV1265 Series Absolute Maximum Ratings (Note 1)**

Parameter	Symbol	Minimum	Typical	Maximum	Units
Power dissipation	P <sub>DIS</sub>			250	mW
Forward current	I <sub>F</sub>			20	mA
Operating temperature	T <sub>OP</sub>	-55		+125	°C
Storage temperature	T <sub>STG</sub>	-55		+150	°C

**Note 1:** Exposure to maximum rating conditions for extended periods may reduce device reliability. There is no damage to device with only one parameter set at the limit and all other parameters set at or below their nominal value. Exceeding any of the limits listed here may result in permanent damage to the device.

**CAUTION:** Although this device is designed to be as robust as possible, electrostatic discharge (ESD) can damage this device. These devices must be protected at all times from ESD. Static charges may easily produce potentials of several kilovolts on the human body or equipment, which can discharge without detection. Industry-standard ESD precautions should be used at all times.

**Table 3. SMV1265 Series Electrical Specifications (Note 1)**

**(T<sub>OP</sub> = 25 °C, Unless Otherwise Noted)**

Parameter	Symbol	Test Condition	Min	Typical	Max	Units
Reverse leakage current	I <sub>R</sub>	V <sub>R</sub> = 26 V			20	nA
Reverse breakdown voltage	V <sub>BR</sub>	I <sub>R</sub> = 10 μA	28			V
Capacitance	C <sub>T1</sub>	V <sub>R</sub> = 1 V, f = 1 MHz	12.5	13.8	14.7	pF
	C <sub>T26</sub>	V <sub>R</sub> = 26 V, f = 1 MHz	0.58	0.70	0.83	pF
Capacitance ratio	C <sub>T1</sub> /C <sub>T26</sub>	C <sub>T</sub> (1 V)/C <sub>T</sub> (26 V)	17.7	19.5		–
Series resistance	R <sub>S</sub>	V <sub>R</sub> = 1 V, f = 470 MHz		2.4		Ω

**Note 1:** Performance is guaranteed only under the conditions listed in this table.

**Typical Performance Characteristics**

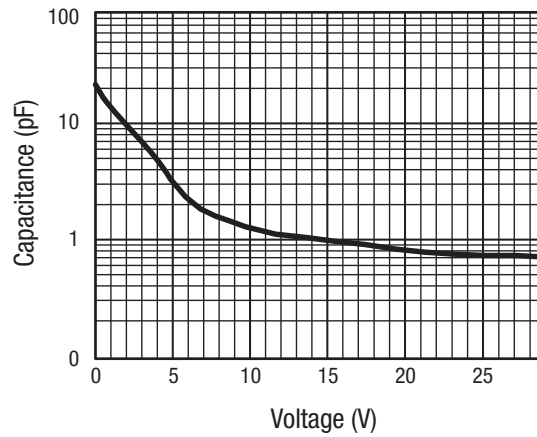

**Figure 1. Capacitance vs Voltage @ 25 °C**

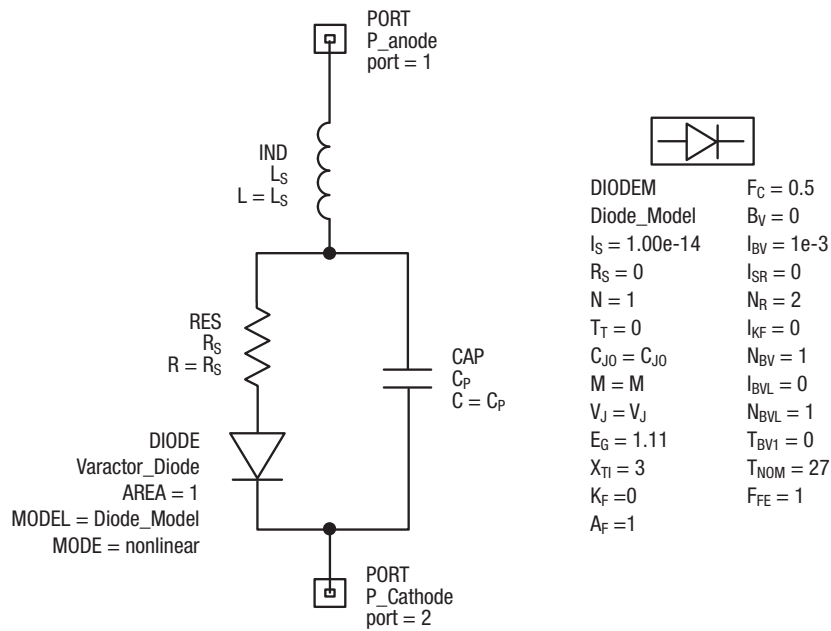

**Figure 2. SPICE Model**

**Table 4. SPICE Model Parameters**

Part Number	CJO (pF)	VJ (V)	M	CP (pF)	RS (Ω)	LS (nH)
SMV1265-011LF	22.5	30	13	0.71	2.4	1.7
SMV1265-040LF	22.5	30	13	0.71	2.4	0.45

**Table 5. SMV1265 Series Voltage vs Capacitance**

Voltage (V <sub>R</sub> ) (V)	Typical Capacitance (C <sub>T</sub> ) (pF)
0	22.47
0.5	17.41
1.0	14.26
2.0	10.23
3.0	7.40
4.0	5.15
5.0	3.38
6.0	2.37
7.0	1.86
8.0	1.61
9.0	1.45
10	1.30
12	1.12
14	1.05
16	0.97
18	0.91
20	0.83
22	0.78
24	0.75
26	0.73
28	0.73
30	0.71

**Package and Handling Information**

The package dimensions and tape and reel dimensions for the SOD-323 are shown in Figures 3 and 4, respectively. The package dimensions and tape and reel dimensions for the SOD-882 are shown in Figures 5 and 6, respectively.

Instructions on the shipping container label regarding exposure to moisture after the container seal is broken must be followed. Otherwise, problems related to moisture absorption may occur when the part is subjected to high temperature during solder assembly.

The SMV1265 series are rated to Moisture Sensitivity Level 1 (MSL1) at 260 °C. They can be used for lead or lead-free soldering. For additional information, refer to the Skyworks Application Note, *Solder Reflow Information*, document number 200164.

Care must be taken when attaching this product, whether it is done manually or in a production solder reflow environment. Production quantities of this product are shipped in a standard tape and reel format.

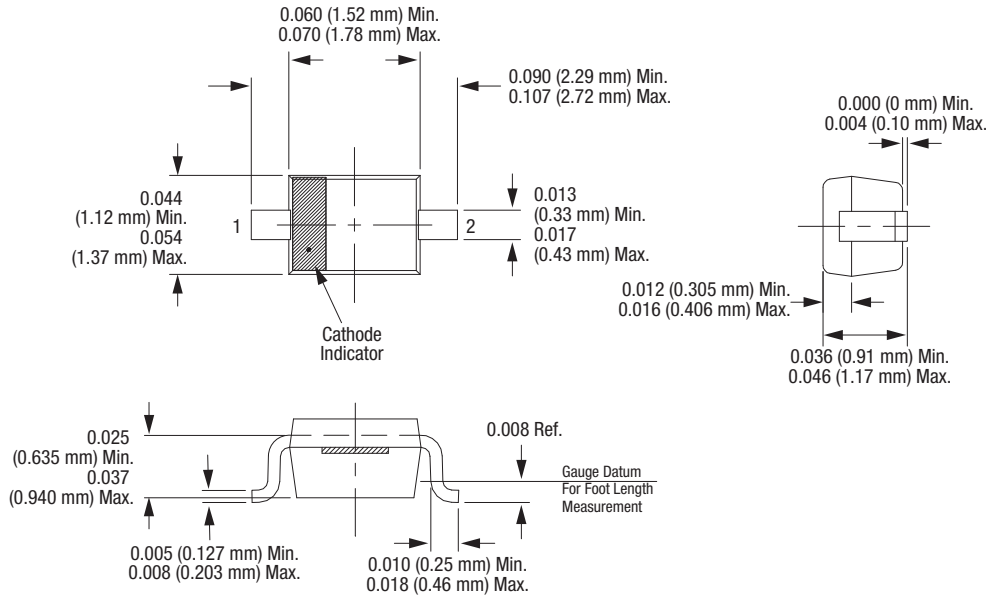

Dimensions are in inches (millimeters shown in parentheses)

S1619

Figure 3. SOD-323 Package Dimensions

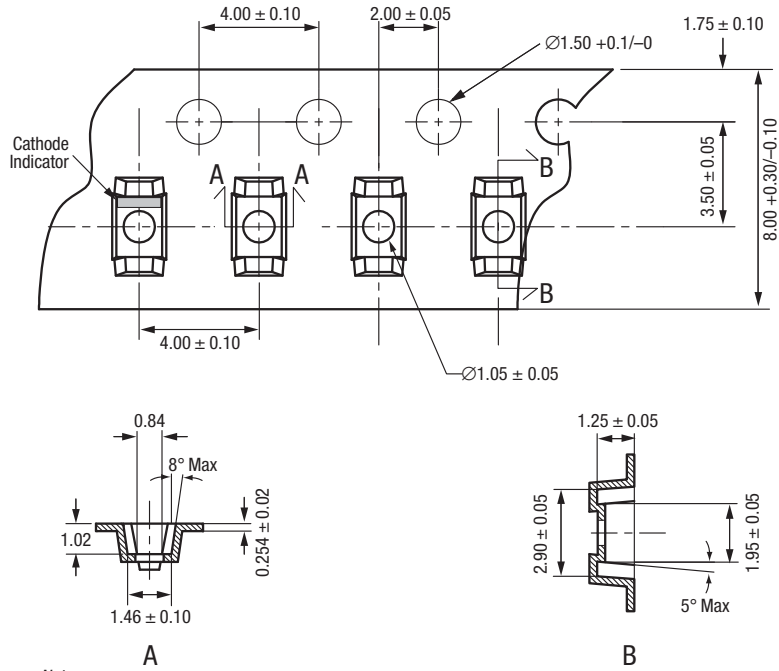

Notes:

1. Carrier tape: black conductive polycarbonate or polystyrene.
2. Cover tape: transparent conductive material.
3. Cover tape size: 5.5 mm width.
4. ESD surface resistivity is  $\geq 1 \times 10^5 \sim \leq 1 \times 10^{11}$  Ohms/square.
5. 10 sprocket hole pitch cumulative tolerance:  $\pm 0.20$  mm.
6.  $A_0$  and  $B_0$  measured on plane 0.30 mm above bottom of the pocket.
7. All measurements are in millimeters.
8. Standard reel size is 7 inches. Standard reel quantity is 3000 pcs.

S2061

Figure 4. SOD-323 Tape and Reel Dimensions

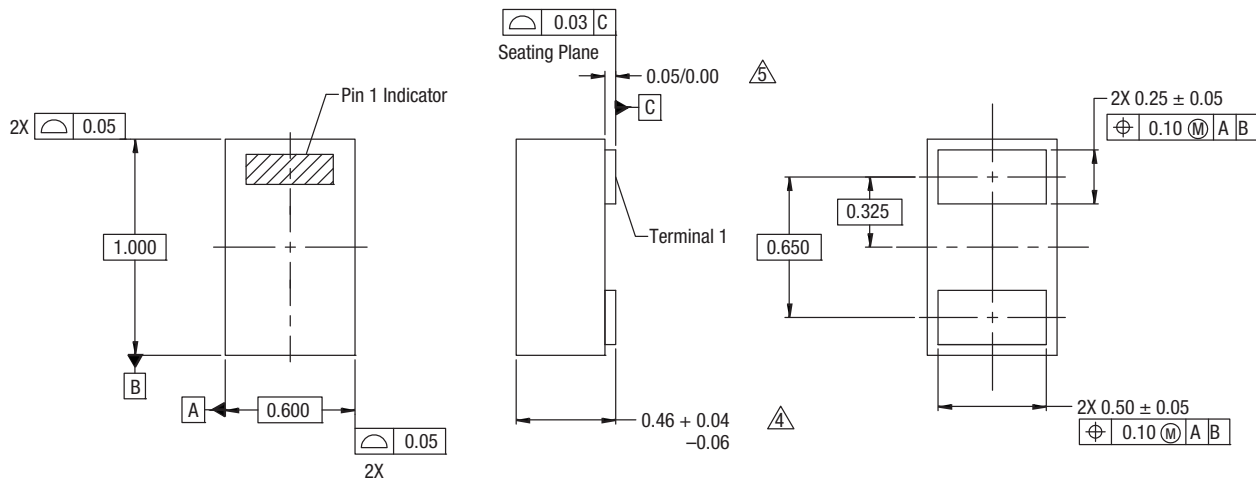

- NOTES:
1. All measurements are in millimeters.
  2. Dimensions and tolerances according to ASME Y14.5M-1994.
  3. These packages are used principally for discrete devices.
  4. This dimension includes stand-off height and package body thickness, but does not include attached features, e.g., external heatsink or chip capacitors. An integral heatslug is not considered an attached feature.
  5. This dimension is primarily terminal plating, but does not include small metal protrusion.

Y1410

Figure 5. SOD-882 Package Dimensions

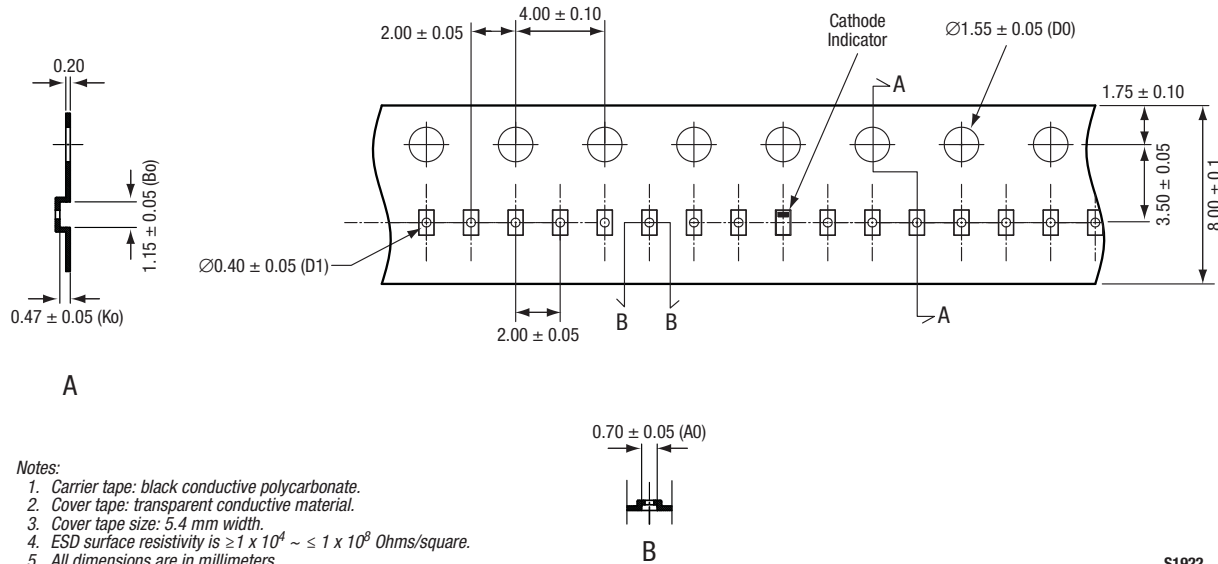

- Notes:
1. Carrier tape: black conductive polycarbonate.
  2. Cover tape: transparent conductive material.
  3. Cover tape size: 5.4 mm width.
  4. ESD surface resistivity is  $\geq 1 \times 10^4 \sim \leq 1 \times 10^8$  Ohms/square.
  5. All dimensions are in millimeters.

S1922

Figure 6. SOD-882 Tape and Reel Dimensions

Copyright © 2002-2007, 2009-2011, 2014 Skyworks Solutions, Inc. All Rights Reserved.

Information in this document is provided in connection with Skyworks Solutions, Inc. ("Skyworks") products or services. These materials, including the information contained herein, are provided by Skyworks as a service to its customers and may be used for informational purposes only by the customer. Skyworks assumes no responsibility for errors or omissions in these materials or the information contained herein. Skyworks may change its documentation, products, services, specifications or product descriptions at any time, without notice. Skyworks makes no commitment to update the materials or information and shall have no responsibility whatsoever for conflicts, incompatibilities, or other difficulties arising from any future changes.

No license, whether express, implied, by estoppel or otherwise, is granted to any intellectual property rights by this document. Skyworks assumes no liability for any materials, products or information provided hereunder, including the sale, distribution, reproduction or use of Skyworks products, information or materials, except as may be provided in Skyworks Terms and Conditions of Sale.

THE MATERIALS, PRODUCTS AND INFORMATION ARE PROVIDED "AS IS" WITHOUT WARRANTY OF ANY KIND, WHETHER EXPRESS, IMPLIED, STATUTORY, OR OTHERWISE, INCLUDING FITNESS FOR A PARTICULAR PURPOSE OR USE, MERCHANTABILITY, PERFORMANCE, QUALITY OR NON-INFRINGEMENT OF ANY INTELLECTUAL PROPERTY RIGHT; ALL SUCH WARRANTIES ARE HEREBY EXPRESSLY DISCLAIMED. SKYWORKS DOES NOT WARRANT THE ACCURACY OR COMPLETENESS OF THE INFORMATION, TEXT, GRAPHICS OR OTHER ITEMS CONTAINED WITHIN THESE MATERIALS. SKYWORKS SHALL NOT BE LIABLE FOR ANY DAMAGES, INCLUDING BUT NOT LIMITED TO ANY SPECIAL, INDIRECT, INCIDENTAL, STATUTORY, OR CONSEQUENTIAL DAMAGES, INCLUDING WITHOUT LIMITATION, LOST REVENUES OR LOST PROFITS THAT MAY RESULT FROM THE USE OF THE MATERIALS OR INFORMATION, WHETHER OR NOT THE RECIPIENT OF MATERIALS HAS BEEN ADVISED OF THE POSSIBILITY OF SUCH DAMAGE.

Skyworks products are not intended for use in medical, lifesaving or life-sustaining applications, or other equipment in which the failure of the Skyworks products could lead to personal injury, death, physical or environmental damage. Skyworks customers using or selling Skyworks products for use in such applications do so at their own risk and agree to fully indemnify Skyworks for any damages resulting from such improper use or sale.

Customers are responsible for their products and applications using Skyworks products, which may deviate from published specifications as a result of design defects, errors, or operation of products outside of published parameters or design specifications. Customers should include design and operating safeguards to minimize these and other risks. Skyworks assumes no liability for applications assistance, customer product design, or damage to any equipment resulting from the use of Skyworks products outside of stated published specifications or parameters.

Skyworks and the Skyworks symbol are trademarks or registered trademarks of Skyworks Solutions, Inc., in the United States and other countries. Third-party brands and names are for identification purposes only, and are the property of their respective owners. Additional information, including relevant terms and conditions, posted at [www.skyworksinc.com](http://www.skyworksinc.com), are incorporated by reference.