



Chipsmall Limited consists of a professional team with an average of over 10 year of expertise in the distribution of electronic components. Based in Hongkong, we have already established firm and mutual-benefit business relationships with customers from,Europe,America and south Asia,supplying obsolete and hard-to-find components to meet their specific needs.

With the principle of “Quality Parts,Customers Priority,Honest Operation,and Considerate Service”,our business mainly focus on the distribution of electronic components. Line cards we deal with include Microchip,ALPS,ROHM,Xilinx,Pulse,ON,Everlight and Freescale. Main products comprise IC,Modules,Potentiometer,IC Socket,Relay,Connector.Our parts cover such applications as commercial,industrial, and automotives areas.

We are looking forward to setting up business relationship with you and hope to provide you with the best service and solution. Let us make a better world for our industry!



Contact us

Tel: +86-755-8981 8866 Fax: +86-755-8427 6832

Email & Skype: info@chipsmall.com Web: www.chipsmall.com

Address: A1208, Overseas Decoration Building, #122 Zhenhua RD., Futian, Shenzhen, China



DATA SHEET

SMV1405 to SMV1430 Series: Plastic Packaged Abrupt Junction Tuning Varactors

Applications

- High-Q resonators in wireless system VCOs
- High volume commercial systems

Features

- High Q
- Low series resistance for low phase noise
- Packages rated MSL1, 260 °C per JEDEC J-STD-020



Skyworks Green™ products are compliant with all applicable legislation and are halogen-free. For additional information, refer to *Skyworks Definition of Green™*, document number SQ04-0074.







Description

The SMV1405 to SMV1430 group of silicon abrupt junction varactor diodes is designed for use in Voltage Controlled Oscillators (VCOs) requiring tight capacitance tolerances. The low resistance of these varactors makes them appropriate for high-Q resonators in wireless system VCOs to frequencies above 10 GHz. This family of varactors is characterized for capacitance over temperature.

Table 1 describes the various packages and markings of the SMV1405 to SMV1430 group of varactors.

Table 1. Packaging and Marking

			
Single	Single	Common Cathode	Single
SC-79 Green™	SOT-23	SOT-23	SOD-882 Green™
SMV1405-079LF Marking: Cathode and A3			SMV1405-040LF Marking: 5
	SMV1408-001LF Green™ Marking: DV1		SMV1408-040LF Marking: DV
SMV1413-079LF Marking: Cathode and A4	SMV1413-001LF Green™ Marking: ER1	SMV1413-004LF Green™ Marking: ER3	
			SMV1430-040LF Marking: 7
Ls = 0.7 nH	Ls = 1.5 nH	Ls = 1.5 nH	Ls = 0.45 nH



The Pb-free symbol or "LF" in the part number denotes a lead-free, RoHS-compliant package unless otherwise noted as Green™. Tin/lead (Sn/Pb) packaging is not recommended for new designs.

Electrical and Mechanical Specifications

The absolute maximum ratings of the SMV1405 to SMV1430 varactors are provided in Table 2. Electrical specifications are provided in Table 3. Typical capacitance values are listed in Table 4. Typical performance characteristics of the SMV1405 to SMV1430 varactors are illustrated in Figures 1, 2, and 3.

The SPICE model for the SMV1405 to SMV1430 varactors is shown in Figure 4, and the associated model parameters are provided in Table 5.

Package Dimensions

Package dimensions are shown in Figures 5 to 9 (odd numbers), and tape and reel dimensions are provided in Figures 6 to 10 (even numbers).

Package and Handling Information

Instructions on the shipping container label regarding exposure to moisture after the container seal is broken must be followed. Otherwise, problems related to moisture absorption may occur when the part is subjected to high temperature during solder assembly.

The SMV1405 to SMV1430 series of varactors are rated to Moisture Sensitivity Level 1 (MSL1) at 260 °C. They can be used for lead or lead-free soldering. For additional information, refer to the Skyworks Application Note, *Solder Reflow Information*, document number 200164.

Care must be taken when attaching this product, whether it is done manually or in a production solder reflow environment. Production quantities of this product are shipped in a standard tape and reel format.

Table 2. SMV1405 to SMV1430 Series Absolute Maximum Ratings¹

Parameter	Symbol	Minimum	Maximum	Units
Reverse voltage	V_R		30	V
Forward current	I_F		20	mA
Power dissipation	P_D		250	mW
Operating temperature	T_{OP}	-55	+125	°C
Storage temperature	T_{STG}	-55	+150	°C

¹ Exposure to maximum rating conditions for extended periods may reduce device reliability. There is no damage to device with only one parameter set at the limit and all other parameters set at or below their nominal value. Exceeding any of the limits listed here may result in permanent damage to the device.

CAUTION: Although this device is designed to be as robust as possible, electrostatic discharge (ESD) can damage this device. This device must be protected at all times from ESD. Static charges may easily produce potentials of several kilovolts on the human body or equipment, which can discharge without detection. Industry-standard ESD precautions should be used at all times.

Table 3. SMV1405 to SMV1430 Series Electrical Specifications¹
($T_{OP} = 25\text{ °C}$, Unless Otherwise Noted)

Part Number	C _T @ 0.5 V (pF)	C _T @ 1 V (pF)	C _T @ 4 V (pF)		$\frac{C_T @ 0 V}{C_T @ 30 V}$ (Ratio)	R _S @ 4 V, 500 MHz (Ω)	Q @ 4 V, 50 MHz
	Typ.	Typ.	Min.	Max.	Min	Max.	Typ.
SMV1405	2.1	1.80	1.21	1.45	4.1	0.80	3200
SMV1408	3.4	2.90	1.71	2.11	4.1	0.60	2900
SMV1413	7.4	6.40	3.64	4.42	4.2	0.35	2400
SMV1430	1.01	0.88	0.46	0.70	3.8	3.15	1680

¹ Performance is guaranteed only under the conditions listed in this table.

Reverse voltage V_R ($I_R = 10\ \mu\text{A}$) = 30 V minimum

Reverse current I_R ($V_R = 24\ \text{V}$) = 20 nA maximum

Total capacitance shown was measured in the SOT-23 single configuration with a typical case capacitance of 0.13 pF. The total capacitance may differ slightly for other packages/configurations.

Table 4. Capacitance vs Reverse Voltage¹

V _R (V)	C _T (pF)			
	SMV1405	SMV1408	SMV1413	SMV1430
0	2.67	4.08	9.24	1.24
0.5	2.12	3.36	7.39	1.01
1.0	1.84	2.94	6.37	0.88
1.5	1.70	2.60	5.71	0.80
2.0	1.55	2.38	5.22	0.74
2.5	1.44	2.24	4.85	0.68
3.0	1.34	2.08	4.55	0.65
4.0	1.25	1.88	4.10	0.60
5.0	1.17	1.72	3.77	0.56
10.0	0.95	1.28	2.85	0.44
20.0	0.77	1.01	2.12	0.35
30.0	0.63	0.95	1.77	0.31

¹ Total capacitance shown was measured in the SOT-23 single configuration with a typical case capacitance of 0.13 pF. The total capacitance may differ slightly for other packages/configurations.

Typical Performance Characteristics

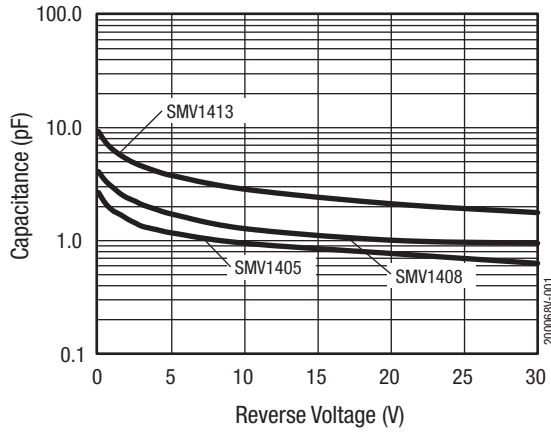

Figure 1. Capacitance vs Reverse Voltage

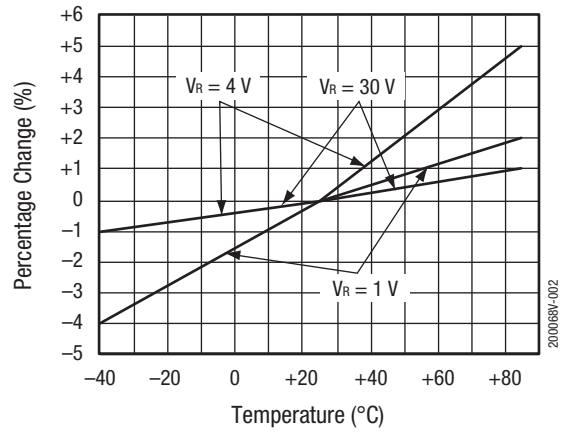

Figure 2. Relative Capacitance Change vs Temperature

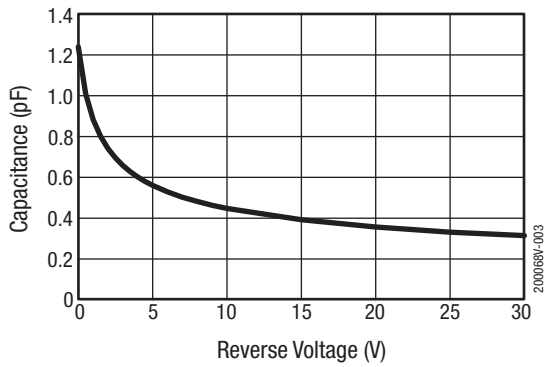

Figure 3. Capacitance vs Reverse Voltage (SMV1430)

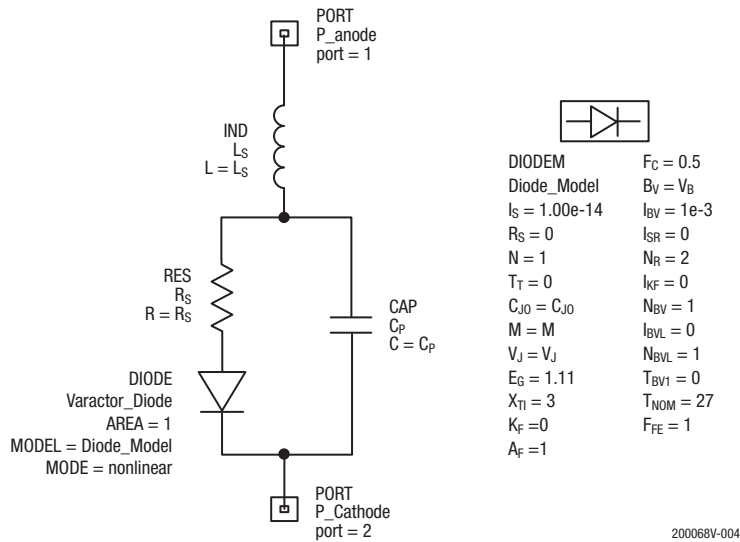

Figure 4. SPICE Model

Table 5. SPICE Model Parameters

Part Number	Cj0 (pF)	Vj (V)	M	Cp (pF)	Rs (Ω)
SMV1405	2.37	0.77	0.5	0.29	0.80
SMV1408	3.89	0.92	0.5	0.21	0.60
SMV1413	8.92	0.87	0.5	0.30	0.35
SMV1430	1.11	0.86	0.5	0.13	3.15

Values extracted from measured performance.

For package inductance, Ls, refer to Table 1.

For more details, refer to the Skyworks Application Note, *Varactor SPICE Model for Approved RF VCO Applications*, document number 200315.

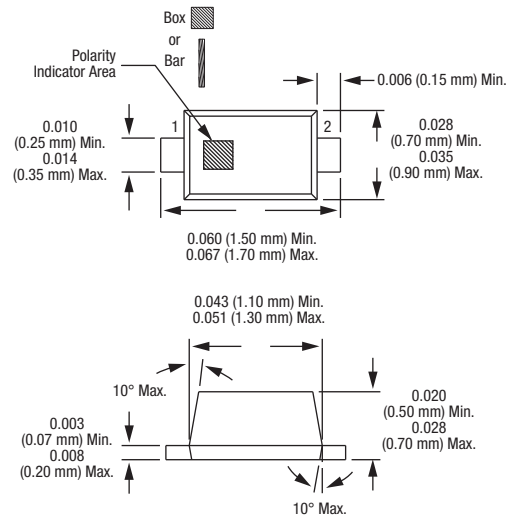

Dimensions are in inches (millimeters shown in parentheses) 200068V-005

Figure 5. SC-79 Package Dimensions

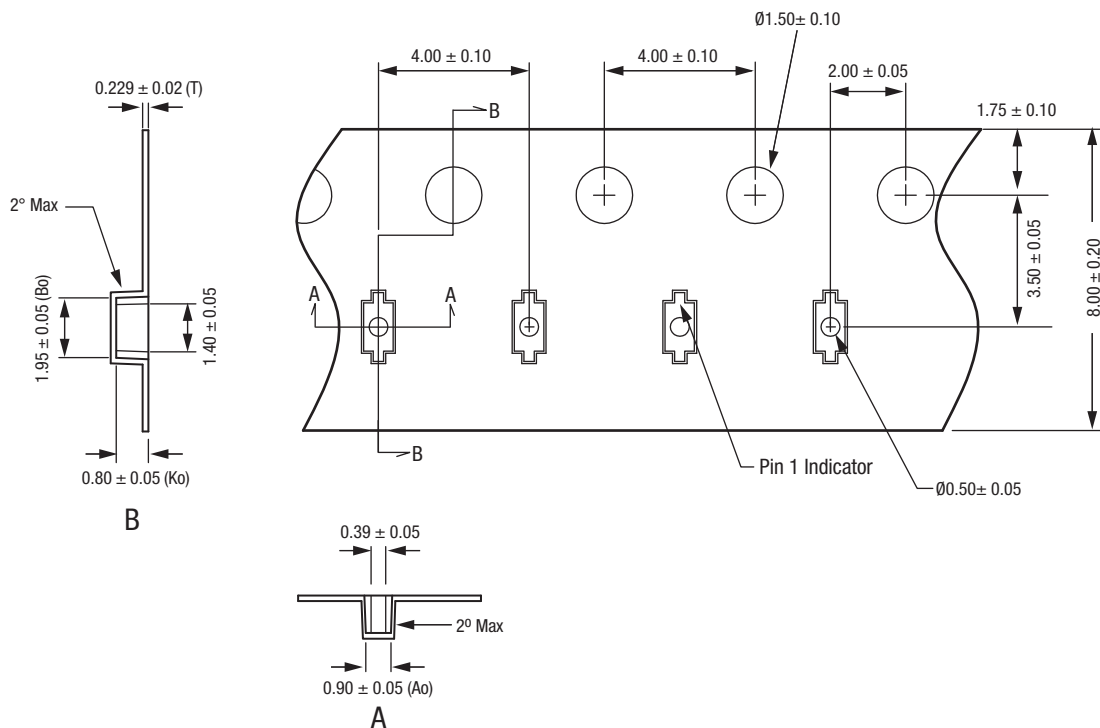

Notes:

1. Carrier tape: black conductive polycarbonate or polystyrene.
2. Cover tape material: transparent conductive PSA.
3. Cover tape size: 5.4 mm width.
4. ESD-surface resistivity is $\leq 1 \times 10^8$ Ohms/square per EIA, JEDEC TNR Specification.
5. All measurements are in millimeters.

200068V-006

Figure 6. SC-79 Tape and Reel Dimensions

DATA SHEET • SMV1405 TO SMV1430 VARACTORS

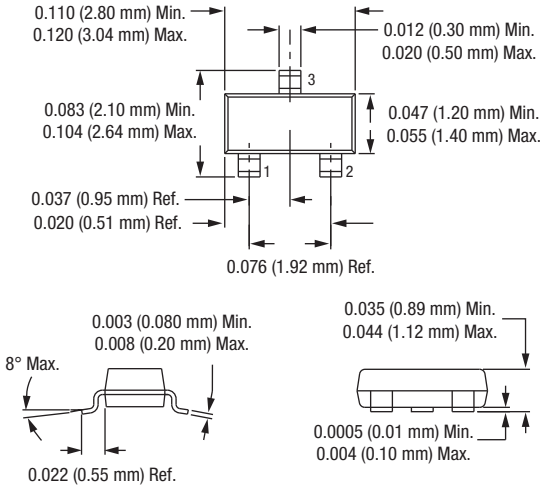

Dimensions are in inches (millimeters shown in parentheses) 200068V-007

Figure 7. SOT-23 Package Dimensions

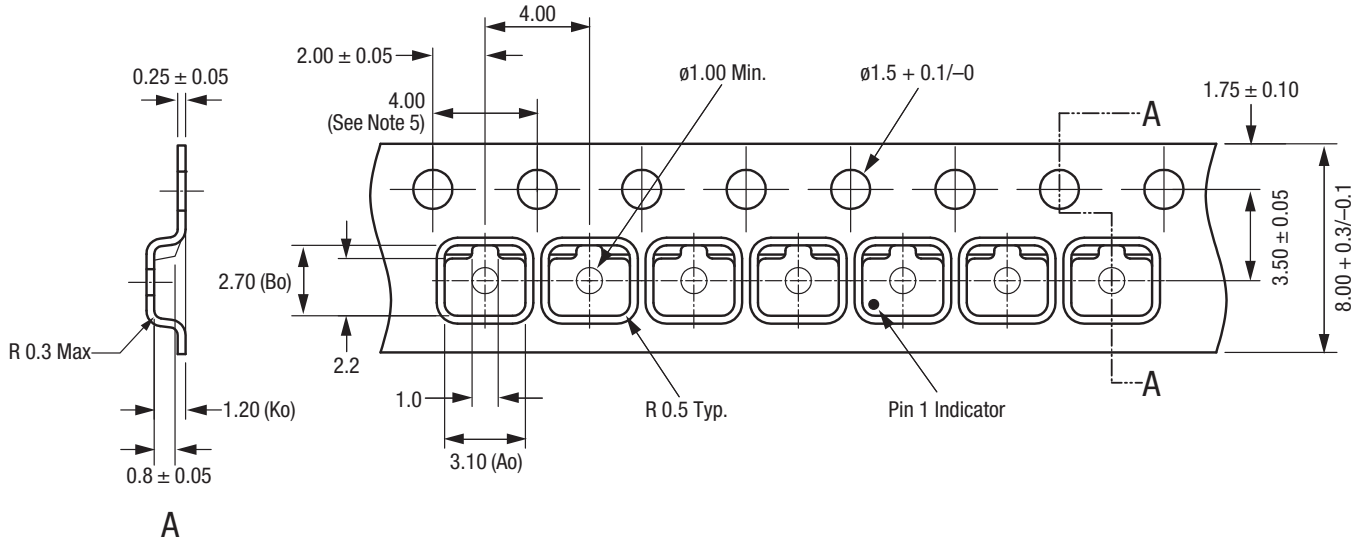

Notes:

1. Carrier tape: black conductive polycarbonate.
2. Cover tape material: transparent conductive PSA.
3. Cover tape size: 5.40 mm width.
4. Tolerance ± 0.10 mm.
5. Ten sprocket hole pitch cumulative tolerance: ± 0.2 mm.
6. All measurements are in millimeters.
7. Alternative carrier tape dimensions are:
 $A_0 = 3.3$
 $B_0 = 2.9$
 $K_0 = 1.22$

200068V-008

Figure 8. SOT-23 Tape and Reel Dimensions

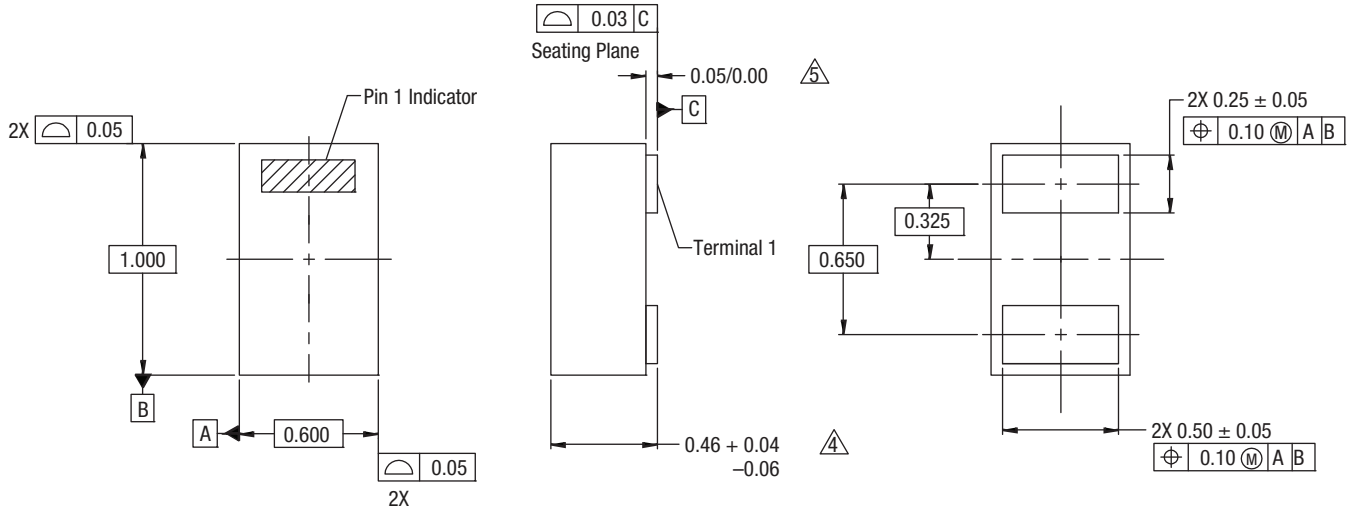

Notes:

1. All measurements are in millimeters.
2. Dimensions and tolerances according to ASME Y14.5M-1994.
3. These packages are used principally for discrete devices.
4. This dimension includes stand-off height and package body thickness, but does not include attached features, e.g., external heatsink or chip capacitors. An integral heatslug is not considered an attached feature.
5. This dimension is primarily terminal plating, but does not include small metal protrusion.

200068V-009

Figure 9. SOD-882 Package Dimensions

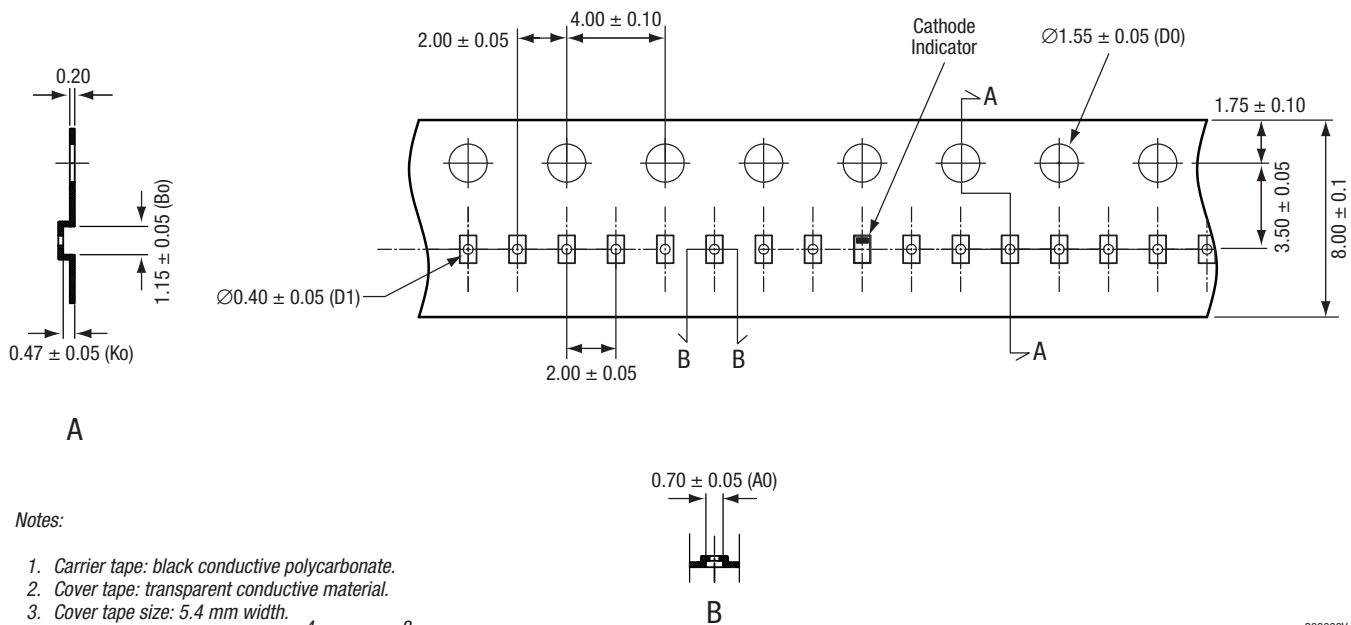

Notes:

1. Carrier tape: black conductive polycarbonate.
2. Cover tape: transparent conductive material.
3. Cover tape size: 5.4 mm width.
4. ESD surface resistivity is $\geq 1 \times 10^4 \sim \leq 1 \times 10^8$ Ohms/square.
5. All dimensions are in millimeters.

200068V-010

Figure 10. SOD-882 Tape and Reel Dimensions

DATA SHEET • SMV1405 TO SMV1430 VARACTORS

Copyright © 2002-2007, 2009-2016 Skyworks Solutions, Inc. All Rights Reserved.

Information in this document is provided in connection with Skyworks Solutions, Inc. ("Skyworks") products or services. These materials, including the information contained herein, are provided by Skyworks as a service to its customers and may be used for informational purposes only by the customer. Skyworks assumes no responsibility for errors or omissions in these materials or the information contained herein. Skyworks may change its documentation, products, services, specifications or product descriptions at any time, without notice. Skyworks makes no commitment to update the materials or information and shall have no responsibility whatsoever for conflicts, incompatibilities, or other difficulties arising from any future changes.

No license, whether express, implied, by estoppel or otherwise, is granted to any intellectual property rights by this document. Skyworks assumes no liability for any materials, products or information provided hereunder, including the sale, distribution, reproduction or use of Skyworks products, information or materials, except as may be provided in Skyworks Terms and Conditions of Sale.

THE MATERIALS, PRODUCTS AND INFORMATION ARE PROVIDED "AS IS" WITHOUT WARRANTY OF ANY KIND, WHETHER EXPRESS, IMPLIED, STATUTORY, OR OTHERWISE, INCLUDING FITNESS FOR A PARTICULAR PURPOSE OR USE, MERCHANTABILITY, PERFORMANCE, QUALITY OR NON-INFRINGEMENT OF ANY INTELLECTUAL PROPERTY RIGHT; ALL SUCH WARRANTIES ARE HEREBY EXPRESSLY DISCLAIMED. SKYWORKS DOES NOT WARRANT THE ACCURACY OR COMPLETENESS OF THE INFORMATION, TEXT, GRAPHICS OR OTHER ITEMS CONTAINED WITHIN THESE MATERIALS. SKYWORKS SHALL NOT BE LIABLE FOR ANY DAMAGES, INCLUDING BUT NOT LIMITED TO ANY SPECIAL, INDIRECT, INCIDENTAL, STATUTORY, OR CONSEQUENTIAL DAMAGES, INCLUDING WITHOUT LIMITATION, LOST REVENUES OR LOST PROFITS THAT MAY RESULT FROM THE USE OF THE MATERIALS OR INFORMATION, WHETHER OR NOT THE RECIPIENT OF MATERIALS HAS BEEN ADVISED OF THE POSSIBILITY OF SUCH DAMAGE.

Skyworks products are not intended for use in medical, lifesaving or life-sustaining applications, or other equipment in which the failure of the Skyworks products could lead to personal injury, death, physical or environmental damage. Skyworks customers using or selling Skyworks products for use in such applications do so at their own risk and agree to fully indemnify Skyworks for any damages resulting from such improper use or sale.

Customers are responsible for their products and applications using Skyworks products, which may deviate from published specifications as a result of design defects, errors, or operation of products outside of published parameters or design specifications. Customers should include design and operating safeguards to minimize these and other risks. Skyworks assumes no liability for applications assistance, customer product design, or damage to any equipment resulting from the use of Skyworks products outside of stated published specifications or parameters.

Skyworks and the Skyworks symbol are trademarks or registered trademarks of Skyworks Solutions, Inc., in the United States and other countries. Third-party brands and names are for identification purposes only, and are the property of their respective owners. Additional information, including relevant terms and conditions, posted at www.skyworksinc.com, are incorporated by reference.