



Chipsmall Limited consists of a professional team with an average of over 10 year of expertise in the distribution of electronic components. Based in Hongkong, we have already established firm and mutual-benefit business relationships with customers from,Europe,America and south Asia,supplying obsolete and hard-to-find components to meet their specific needs.

With the principle of “Quality Parts,Customers Priority,Honest Operation,and Considerate Service”,our business mainly focus on the distribution of electronic components. Line cards we deal with include Microchip,ALPS,ROHM,Xilinx,Pulse,ON,Everlight and Freescale. Main products comprise IC,Modules,Potentiometer,IC Socket,Relay,Connector.Our parts cover such applications as commercial,industrial, and automotives areas.

We are looking forward to setting up business relationship with you and hope to provide you with the best service and solution. Let us make a better world for our industry!



Contact us

Tel: +86-755-8981 8866 Fax: +86-755-8427 6832

Email & Skype: info@chipsmall.com Web: www.chipsmall.com

Address: A1208, Overseas Decoration Building, #122 Zhenhua RD., Futian, Shenzhen, China



SNA series (1A,3A)

SNA -03 -223 -□

① ② ③ ④

- ① Model Name
- ② Rated Current
- ③ Line to ground capacitor code: See table 1.1.

table 1.1 Line to ground capacitor code

Code	Line to ground capacitor (nominal value)
000	Not Provided
223	22000pF

- ④ Options
- D: DIN rail installation type

* The dimensions change when the option is set. Refer to External view.

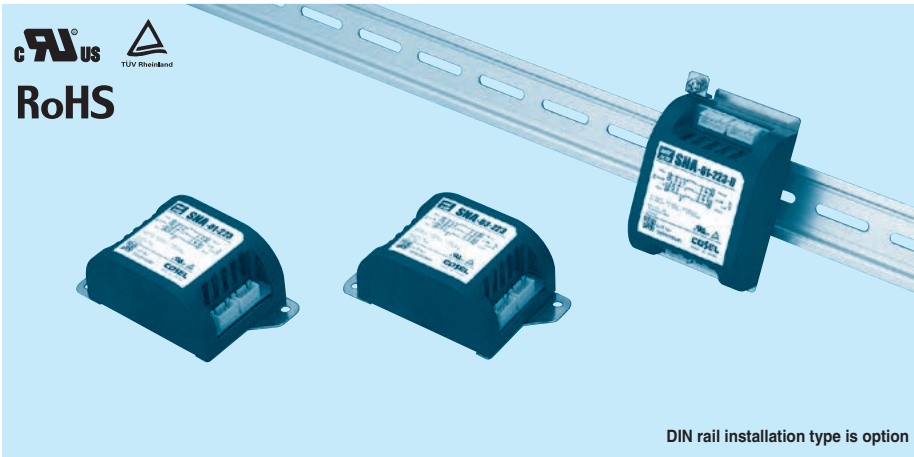

Features of SNA series (1A and 3A)

Ripple noise attenuation type for switch mode power supplies(DC)

- ±50 VDC
- Best filter for switch mode power supplies of analog circuits (ex. power supply filter for an operational amplifier)

Specifications

No.	Items	SNA-01-223	SNA-03-223
		Interface: Connector	
1	Rated Voltage DC[V]	±50 (+Vin - COM-in, -Vin - COM-in)	
2	Rated Current DC[A]	1	3
3	Test Voltage (Terminal-Mounting Plate)	500 VAC (Cutoff Current = 100mA), 1minute at room temperature and humidity	
4	Isolation Resistance (Terminal-Mounting Plate)	500 VDC 50MΩ min at room temperature and humidity	
5	DC resistance	190mΩ max	90mΩ max
6	Operating temperature	-40 to +71°C (Refer to Derating Curve)	
7	Operating humidity	20 to 95%RH (Non condensing)	
8	Storage temperature/humidity	-40 to +75°C/20 to 95%RH (Non condensing)	
9	Vibration	10 to 55Hz, 19.6m/s ² (2G), 3min. Period, 1hour each X, Y and Z axis	
10	Impact	196.1m/s ² (20G), 11ms Once each X, Y and Z axis	
11	Safety agency approvals	UL60950-1, C-UL (CSA60950-1), EN60950-1	
12	Case size (without projection) /Weight	52 X 35 X 93 mm [2.05 X 1.38 X 3.66 inches] (W X H X D) /130g max (Option : -D refer to external view)	

Circuit Diagram

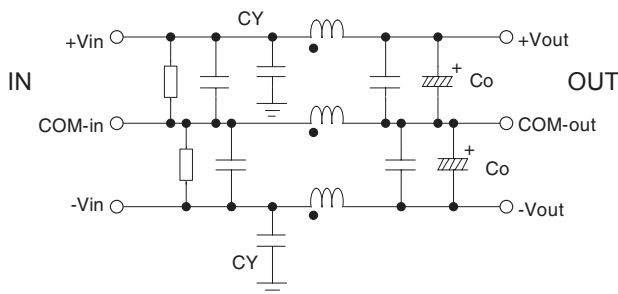

CY : Line to ground capacitor Co : Electrolytic capacitor : Mounting Plate

■ Expected life : 10 years

Derating Curve

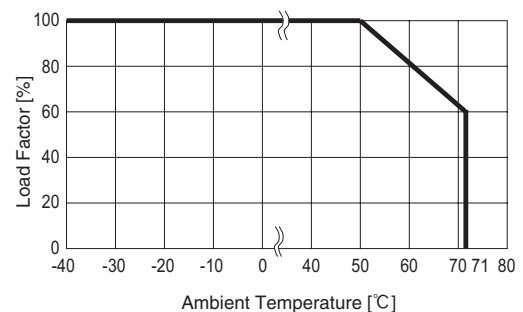

External view

Standard Type

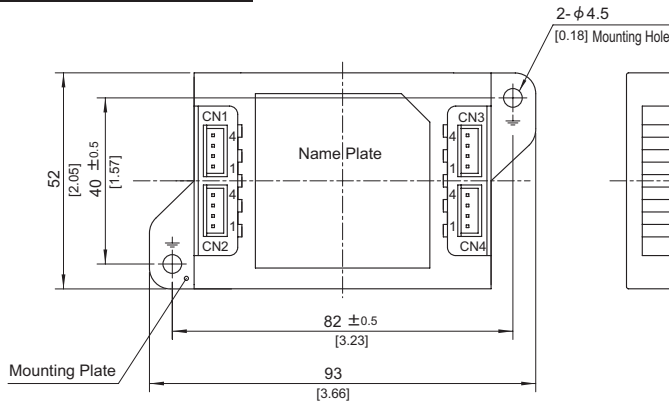

CN1	
Pin No.	Function
1,2	COM-in
3,4	+Vin

CN3	
Pin No.	Function
1,2	COM-out
3,4	+Vout

CN2	
Pin No.	Function
1,2	-Vin
3,4	COM-in

CN4	
Pin No.	Function
1,2	-Vout
3,4	COM-out

I/O Connector	Mating connector	Terminal
CN1-CN4	B4B-XH-AM	XHP-4
		Reel: SXH-001T-P0.6
		Bulk: BXH-001T-P0.6

(Mfr.: J.S.T)

Option harness : Refer to Instruction Manual 4

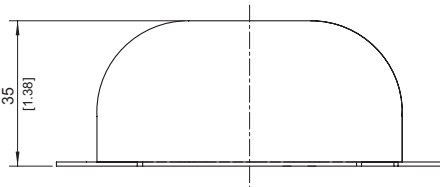

※ Tolerance : ±1 [±0.04]

※ Weight : 130g max

※ PCB Material /thickness : CEM3 /1.6mm [0.06 inches]

※ Mounting plate : Iron (surface finishing : nickel plating) t=1.0 [0.04]

※ Case : PBT

※ Dimensions in mm, []=inches

※ Keeping drawing current per pin below 2A for CN1 to CN4

DIN rail installation Type

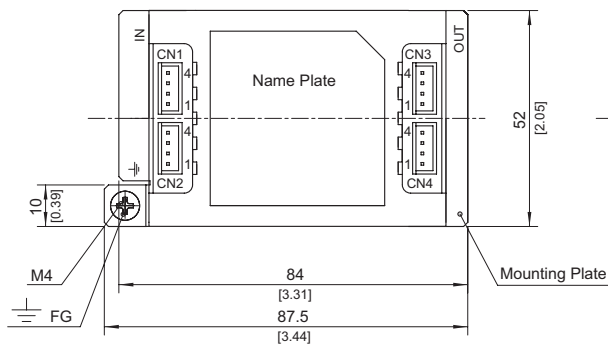

CN1	
Pin No.	Function
1,2	COM-in
3,4	+Vin

CN3	
Pin No.	Function
1,2	COM-out
3,4	+Vout

CN2	
Pin No.	Function
1,2	-Vin
3,4	COM-in

CN4	
Pin No.	Function
1,2	-Vout
3,4	COM-out

I/O Connector	Mating connector	Terminal
CN1-CN4	B4B-XH-AM	XHP-4
		Reel: SXH-001T-P0.6
		Bulk: BXH-001T-P0.6

(Mfr.: J.S.T)

Option harness : Refer to Instruction Manual 4

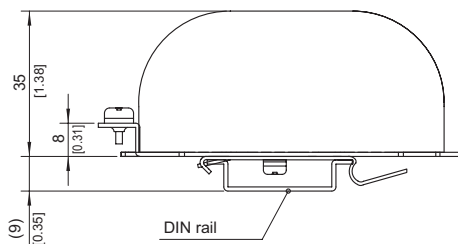

※ Tolerance : ±1 [±0.04]

※ Weight : 140g max

※ PCB Material /thickness : CEM3 /1.6mm [0.06 inches]

※ Mounting plate : Iron (surface finishing : nickel plating) t=1.0 [0.04]

※ Case : PBT

※ Dimensions in mm, []=inches

※ Keeping drawing current per pin below 2A for CN1 to CN4

■Note when installing the EMI/EMC Filter on a DIN rail.

When the EMI/EMC Filter is grounded through the DIN rail, the proper noise attenuation may not be achieved.

Be sure to connect the FG terminal of the EMI/EMC Filter body to the earth.

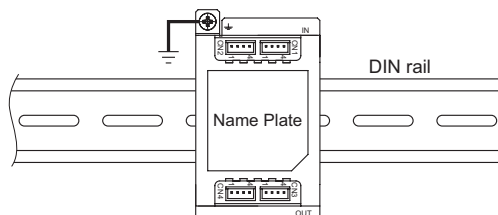

SNA series (6A)

SNA -06 -223 -□

① ② ③ ④

- ① Model Name
- ② Rated Current
- ③ Line to ground capacitor code: See table 1.1.

table 1.1 Line to ground capacitor code

Code	Line to ground capacitor (nominal value)
000	Not Provided
223	22000pF

- ④ Options
- D :DIN rail installation type
- T :Terminal block type
- DT :Terminal block and DIN rail type

* The dimensions change when the option is set. Refer to External view.

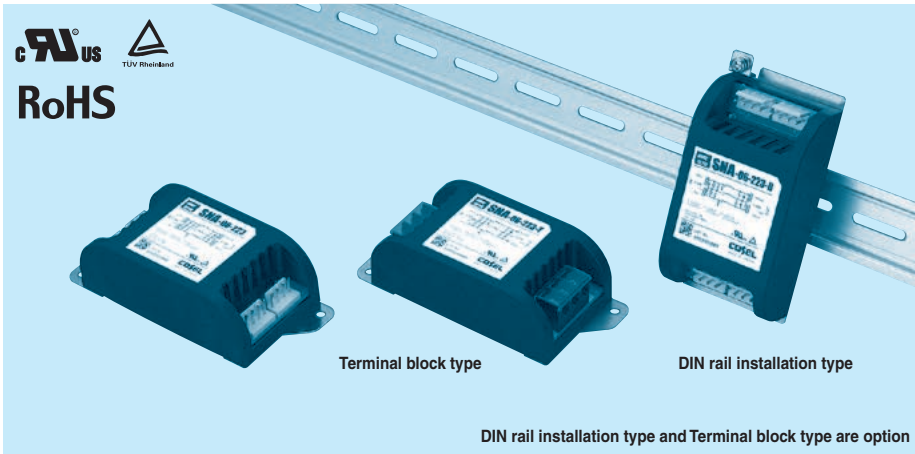

Features of SNA series (6A)

Ripple noise attenuation type for switch mode power supplies(DC)

- ±50 VDC
- Best filter for switch mode power supplies of analog circuits (ex. power supply filter for an operational amplifier)

Specifications

No.	Items	SNA-06-223
		Interface:Connector
1	Rated Voltage DC[V]	±50 (+Vin - COM-in, -Vin - COM-in)
2	Rated Current DC[A]	6
3	Test Voltage (Terminal-Mounting Plate)	500 VAC (Cutoff Current = 100mA), 1minute at room temperature and humidity
4	Isolation Resistance (Terminal-Mounting Plate)	500 VDC 50MΩ min at room temperature and humidity
5	DC resistance	50mΩ max
6	Operating temperature	-40 to +71°C (Refer to Derating Curve)
7	Operating humidity	20 to 95%RH (Non condensing)
8	Storage temperature/humidity	-40 to +75°C/20 to 95%RH (Non condensing)
9	Vibration	10 to 55Hz, 19.6m/s ² (2G), 3min. Period, 1hour each X, Y and Z axis
10	Impact	196.1m/s ² (20G), 11ms Once each X, Y and Z axis
11	Safety agency approvals	UL60950-1, C-UL (CSA60950-1), EN60950-1
12	Case size (without projection) /Weight	52 X 35 X 117 mm [2.05 X 1.38 X 4.61 inches] (W X H X D) /150g max (Option : -D, -T, -DT refer to external view)

Circuit Diagram

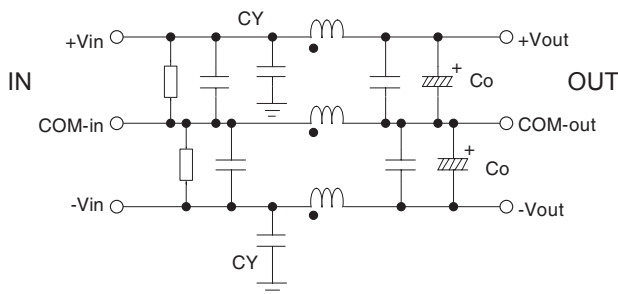

CY : Line to ground capacitor Co : Electrolytic capacitor : Mounting Plate

■ Expected life : 10 years

Derating Curve

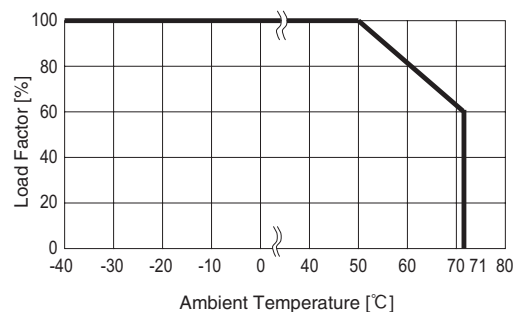

External view

Standard Type

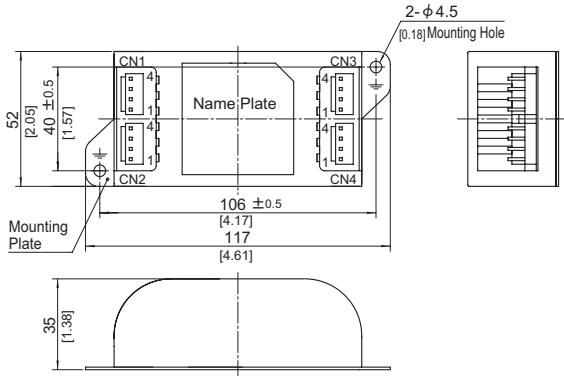

- ※ Tolerance : ± 1 [± 0.04]
- ※ Weight : 150g max
- ※ PCB Material /thickness : CEM3 /1.6mm [0.06 inches]
- ※ Mounting plate : Iron (surface finishing : nickel plating) $t=1.0$ [0.04]
- ※ Case : PBT
- ※ Dimensions in mm, []=inches
- ※ Keeping drawing current per pin below 5A for CN1 to CN4

CN1		CN3	
Pin No.	Function	Pin No.	Function
1,2	COM-in	1,2	COM-out
3,4	+Vin	3,4	+Vout

CN2		CN4	
Pin No.	Function	Pin No.	Function
1,2	-Vin	1,2	-Vout
3,4	COM-in	3,4	COM-out

I/O Connector	Mating connector	Terminal
CN1-CN4	B4P-VH VHR-4N	Reel:SVH-21T-P1.1 Bulk:BVH-21T-P1.1

(Mfr:J.S.T)

Option harness : Refer to Instruction Manual 4

Terminal block Type

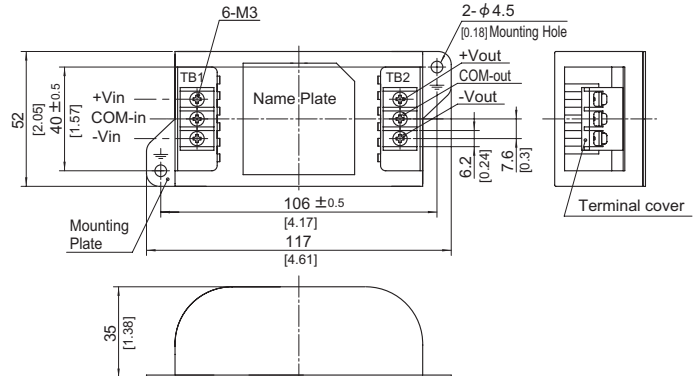

- ※ Tolerance : ± 1 [± 0.04]
- ※ Weight : 160g max
- ※ PCB Material /thickness : CEM3 /1.6mm [0.06 inches]
- ※ Mounting plate : Iron (surface finishing : nickel plating) $t=1.0$ [0.04]
- ※ Case : PBT
- ※ Dimensions in mm, []=inches
- ※ Terminal block screw tightening torque M3:0.8N · m (8.5kgf · cm) max

DIN rail installation Type

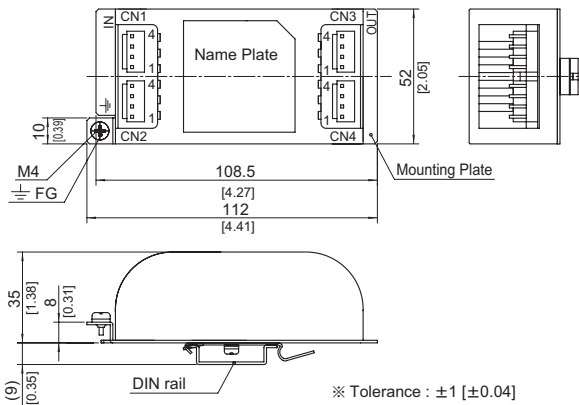

- ※ Tolerance : ± 1 [± 0.04]
- ※ Weight : 160g max
- ※ PCB Material /thickness : CEM3 / 1.6mm [0.06 inches]
- ※ Mounting plate : Iron (surface finishing : nickel plating) $t=1.0$ [0.04]
- ※ Case : PBT
- ※ Dimensions in mm, []=inches
- ※ Keeping drawing current per pin below 5A for CN1 to CN4

CN1		CN3	
Pin No.	Function	Pin No.	Function
1,2	COM-in	1,2	COM-out
3,4	+Vin	3,4	+Vout

CN2		CN4	
Pin No.	Function	Pin No.	Function
1,2	-Vin	1,2	-Vout
3,4	COM-in	3,4	COM-out

I/O Connector	Mating connector	Terminal
CN1-CN4	B4P-VH VHR-4N	Reel:SVH-21T-P1.1 Bulk:BVH-21T-P1.1

(Mfr:J.S.T)

Option harness : Refer to Instruction Manual 4

Terminal block type+DIN rail installation Type

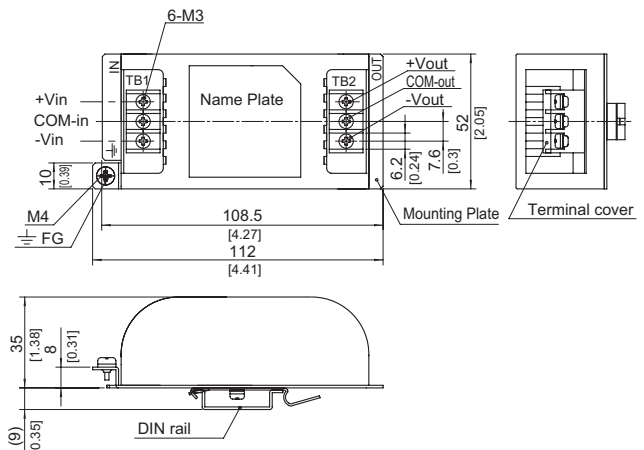

- ※ Tolerance : ± 1 [± 0.04]
- ※ Weight : 170g max
- ※ PCB Material /thickness : CEM3 /1.6mm [0.06 inches]
- ※ Mounting plate : Iron (surface finishing : nickel plating) $t=1.0$ [0.04]
- ※ Case : PBT
- ※ Dimensions in mm, []=inches
- ※ Terminal block screw tightening torque M3:0.8N · m (8.5kgf · cm) max

■Note when installing the EMI/EMC Filter on a DIN rail.

When the EMI/EMC Filter is grounded through the DIN rail, the proper noise attenuation may not be achieved.

Be sure to connect the FG terminal of the EMI/EMC Filter body to the earth.

