



Chipsmall Limited consists of a professional team with an average of over 10 year of expertise in the distribution of electronic components. Based in Hongkong, we have already established firm and mutual-benefit business relationships with customers from,Europe,America and south Asia,supplying obsolete and hard-to-find components to meet their specific needs.

With the principle of “Quality Parts,Customers Priority,Honest Operation,and Considerate Service”,our business mainly focus on the distribution of electronic components. Line cards we deal with include Microchip,ALPS,ROHM,Xilinx,Pulse,ON,Everlight and Freescale. Main products comprise IC,Modules,Potentiometer,IC Socket,Relay,Connector.Our parts cover such applications as commercial,industrial, and automotives areas.

We are looking forward to setting up business relationship with you and hope to provide you with the best service and solution. Let us make a better world for our industry!



## Contact us

Tel: +86-755-8981 8866 Fax: +86-755-8427 6832

Email & Skype: info@chipsmall.com Web: www.chipsmall.com

Address: A1208, Overseas Decoration Building, #122 Zhenhua RD., Futian, Shenzhen, China



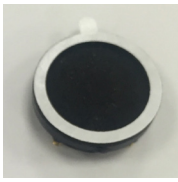

**MODEL:** SP-2005S  
**PRODUCT:** Dynamic Speaker  
**EDITION:** B/2017

**THIS SPECIFICATION COVERS OUR PRODUCT OF DYNAMIC SPEAKER UNIT FOR MOBILE PHONE USE**

**DYNAMIC SPEAKER ELECTROACOUSTIC CHARACTERISTICS**

sound pressure level	91±3dB (0.1W/0.1M) @AVE 0.8KHz,1.0KHz,1.5KHz, 2.0KHz (0dB SPL=20µPa)
measuring condition	1W (Sine wave) 10cm measured with baffler shown in Fig.1
ac impedance	8±15%Ω (@ 2 KHz 1V) without baffler
frequency response curve	As shown in Fig.2
resonance frequency	750±20% Hz @1.0V (without Baffler)
rated noise power	0.8W
short-term max. power	1.0W must be at a white noise (F0~20KHz) for one minute
frequency range	F0~ 20KHz
test set up	Measuring conditions and procedures shown in Fig.1
AC impedance	8Ω±15%
distortion	Less Than 10% @1KHz, 10cm, 0.1W
buzz, rattle,etc	Not audible from 300Hz to 8KHz with 2.53V sine wave input
dimension	ø 20.0x7.7mm

**GENERAL SPECIFICATIONS**

operating temperature range	-20°C ~ +60°C
storage temperature range	-25°C ~ +65°C
standard test conditions	
temperature	17°C ~ 25°C
relative humidity	45% ~ 80%(RH)

**MEASURING METHOD (SPEAKER MODE) (Figure 1)**

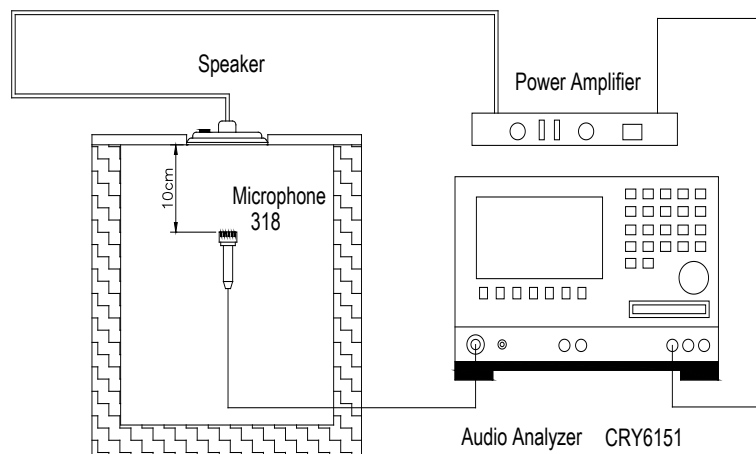

TEST CONDITION	
STANDARD	
temperature	15 ~ 35°C
relative humidity	45% ~ 85%
atmospheric pressure	860mbar to 1060mbar.
STANDARD TEST FIXTURE	
input power	0.1W (0.89V)
zero level	-dB
mode	TSR
potentiometer range	50dB
sweep time	0.5sec

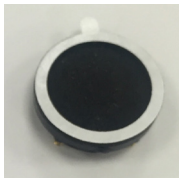

**MODEL:** SP-2005S  
**PRODUCT:** Dynamic Speaker  
**EDITION:** B/2017

Soberton Inc.

**TYPICAL FREQUENCY RESPONSE CURVE (Figure 2)**

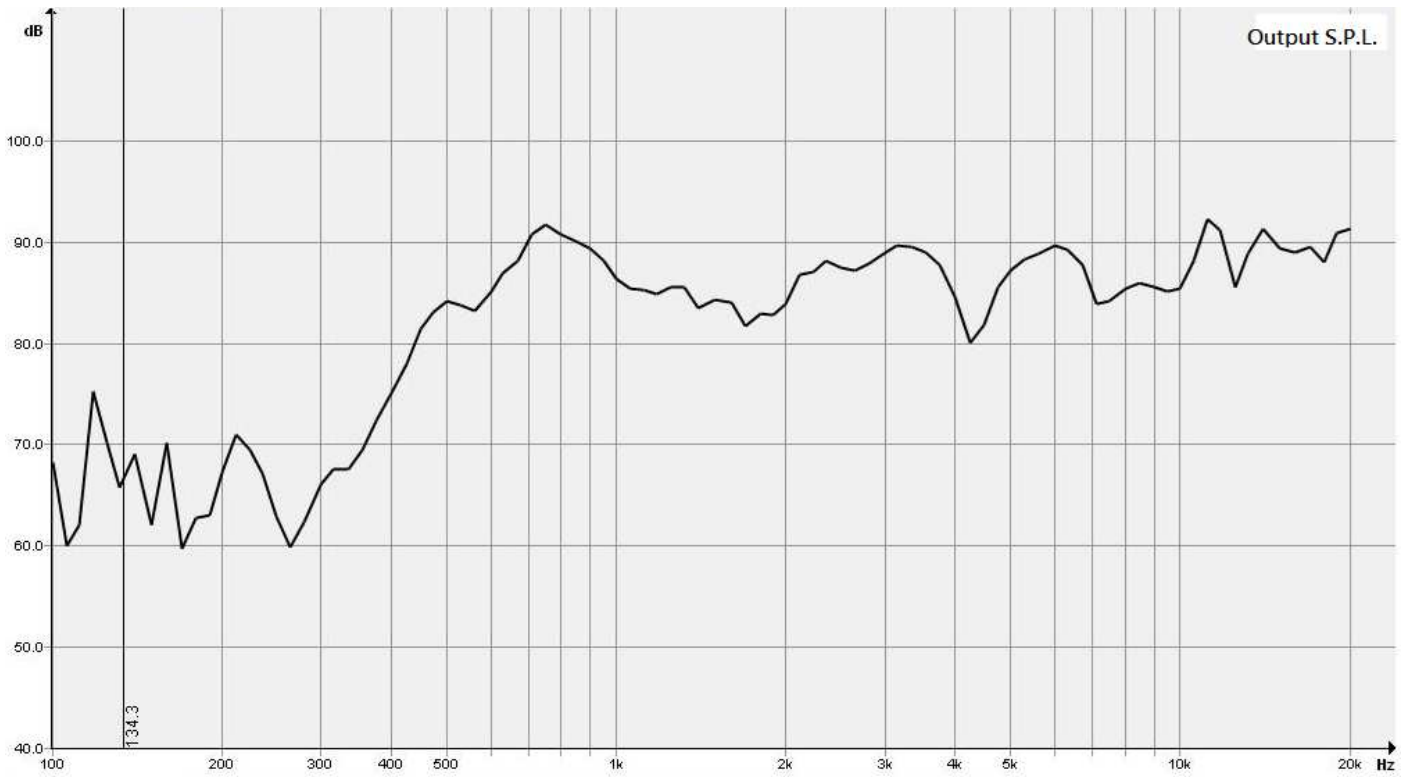

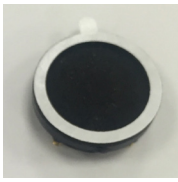

**MODEL:** SP-2005S  
**PRODUCT:** Dynamic Speaker  
**EDITION:** B/2017

## RELIABILITY TESTS

The sound pressure as specified shall neither deviate more than  $\pm 3\text{dB}$  from the initial value, nor have any significant damage after any of following testing.

### HIGH TEMPERATURE TEST

high temperature	+60 °C $\pm 2^\circ\text{C}$
duration	96 hours

### LOW TEMPERATURE TEST

low temperature	-20 °C $\pm 2^\circ\text{C}$
duration	96 hours

### HEAT SHOCK TEST

high temperature	+60 °C $\pm 2^\circ\text{C}$
low temperature	-20 °C $\pm 2^\circ\text{C}$
duration	1 hour
changeover time	< 30 seconds
cycle	100

### HUMIDITY TEST

temperature	+40 °C $\pm 2^\circ\text{C}$
relative humidity	90~95%
duration	96 hours

### TEMPERATURE CYCLE TEST

temperature	-20°C	+65°C
duration	45 minutes	45 minutes
temperature gradient	1~3°C/min.	
cycle	25	

### DROP TEST

mounted with dummy set mass	100 g
height	1.5 m
cycle	6 (1 each plain) onto the concrete board

### LOAD TEST

noise signal	White noise (EIA filter)
input power	0.8W
duration	96 hours



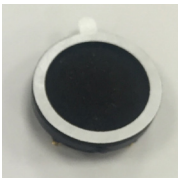

**MODEL:** SP-2005S  
**PRODUCT:** Dynamic Speaker  
**EDITION:** B/2017

**DIMENSIONS**

Tolerance: ±0.5 (unit: mm)

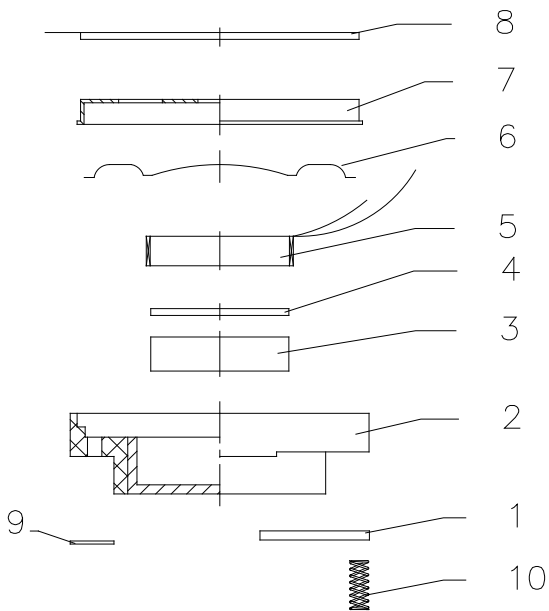
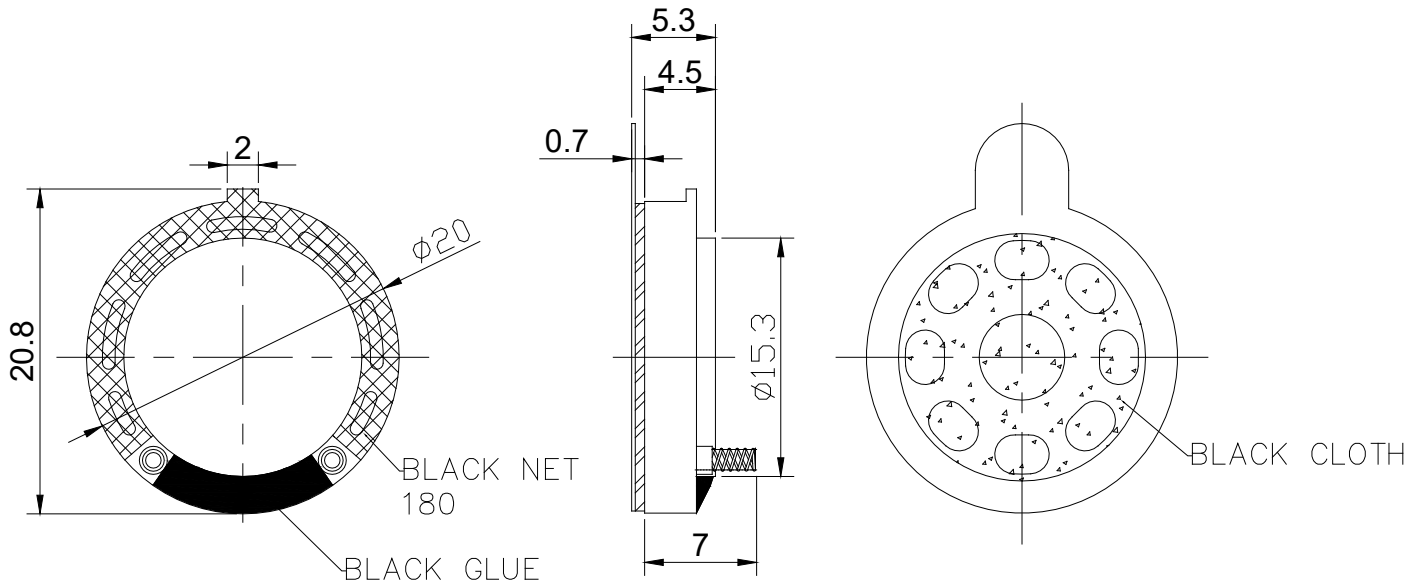

no	item	material	quantity
1	PCB	FR-4	1
2	Frame	PBT	1
3	Main Magnet	Nd Fe B	1
4	Plate	SPCC	1
5	Voice Coil	Copper	1
6	Membrane	PEN	1
7	Cap	SUS304	1
8	Screen Gasket	Black Cloth	1
9	Silk Screen	Black Cloth	1
10	Spring	Bronze	2

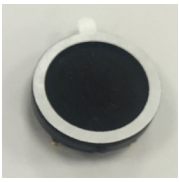

**MODEL:** SP-2005S  
**PRODUCT:** Dynamic Speaker  
**EDITION:** B/2017

Soberton Inc.

## PACKING

50 pcs per tray  
20 trays for unit  
2 unit per carton  
Total:2000 pcs per box  
Size:500×350×330mm

