



Chipsmall Limited consists of a professional team with an average of over 10 year of expertise in the distribution of electronic components. Based in Hongkong, we have already established firm and mutual-benefit business relationships with customers from,Europe,America and south Asia,supplying obsolete and hard-to-find components to meet their specific needs.

With the principle of “Quality Parts,Customers Priority,Honest Operation,and Considerate Service”,our business mainly focus on the distribution of electronic components. Line cards we deal with include Microchip,ALPS,ROHM,Xilinx,Pulse,ON,Everlight and Freescale. Main products comprise IC,Modules,Potentiometer,IC Socket,Relay,Connector.Our parts cover such applications as commercial,industrial, and automotives areas.

We are looking forward to setting up business relationship with you and hope to provide you with the best service and solution. Let us make a better world for our industry!



## Contact us

Tel: +86-755-8981 8866 Fax: +86-755-8427 6832

Email & Skype: info@chipsmall.com Web: www.chipsmall.com

Address: A1208, Overseas Decoration Building, #122 Zhenhua RD., Futian, Shenzhen, China



# SFH756 / SFH756V

## Plastic Fiber Optic Transmitter Diode

### Plastic Connector Housing



## Data Sheet

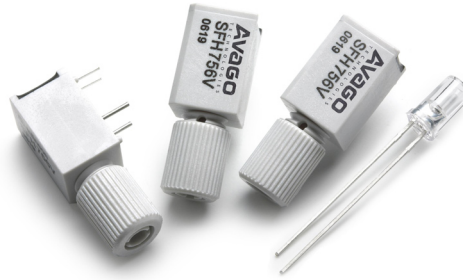

### Description

The SFH756 is a low-cost transmitter for simple optical data transmission with polymer optical fiber. The 650nm LED allows for speeds up to 10MBd.

The transparent plastic package has an aperture where the 2.2mm fiber-end can be inserted and fixed with glue. This easy coupling method is extremely cost-effective.

The V-housing allows easy coupling of unconnectorized 2.2mm plastic optical fiber by means of an axial locking screw.

### Ordering Information

Type	Ordering Code
SFH756	SP000063802
SFH756V	SP000063814

### Features

- 2.2 mm Aperture holds Standard 1000 Micron Plastic Fiber
- No Fiber Stripping Required
- Good Linearity (Forward current > 2 mA)
- Molded Microlens for Efficient Coupling

### Plastic Connector Housing

- Mounting Screw Attached to the Connector
- Interference Free Transmission from light-Tight Housing
- Transmitter and Receiver can be flexibly positioned
- No Cross Talk
- Auto insertable and Wave solderable
- Supplied in Tubes

### Applications

- Household Electronics
- Power Electronics
- Optical Networks
- Light Barriers

## Technical Data

### Absolute Maximum Ratings

Parameter	Symbol	Limit Values		Unit
		min.	max.	
Operating Temperature Range	$T_{OP}$	-40	+85	°C
Storage Temperature Range	$T_{STG}$	-40	+100	°C
Junction Temperature	$T_J$		100	°C
Soldering Temperature (27mm from case bottom, $t \leq 5$ s)	$T_S$		260	°C
Reverse Voltage	$V_R$		3	V
Forward Current	$I_F$		50	mA
Surge Current ( $t \leq 10$ $\mu$ s, $D = 0$ )	$I_{FSM}$		1	A
Power Dissipation	$P_{TOT}$		120	mW
Thermal Resistance, Junction/Air	$R_{thJA}$		450	K/W

### Characteristics ( $T_A = 25^\circ\text{C}$ )

Parameter	Symbol	Value	Unit
Peak Wavelength	$\lambda_{Peak}$	660	nm
Spectral Bandwidth	$\Delta\lambda$	25	nm
Switching Times ( $R_G = 50 \Omega$ , $I_{F(Low)} = 0.1$ mA, $I_{F(High)} = 50$ mA)			$\mu$ s
10% to 90%	$t_R$	0.1	
90% to 10%	$t_F$	0.1	
Capacitance ( $f = 1$ MHz, $V_R = 0$ V)	$C_0$	30	pF
Forward Voltage ( $I_F = 50$ mA)	$V_F$	2.1 ( $\leq 2.8$ )	V
Output Power Coupled Into Plastic Fiber ( $I_F = 10$ mA) [1]	$\Phi_{IN}$	200 ( $\geq 100$ )	$\mu$ W
Temperature Coefficient $\Phi_{IN}$	$T_{C\Phi}$	-0.4	%/K
Temperature Coefficient $V_F$	$T_{CV}$	-3	mV/K
Temperature Coefficient $\lambda_{Peak}$	$T_{C\lambda}$	0.16	nm/K

#### Notes:

1. The output power coupled into plastic fiber is measured with a large area detector after a short fiber (about 30 cm). This value must not be used for calculating the power budget for a fiber optic system with a long fiber because the numerical aperture of plastic fibers is decreasing on the first meters. Therefore the fiber seems to have compared with the specified value a higher attenuation on the first meters.

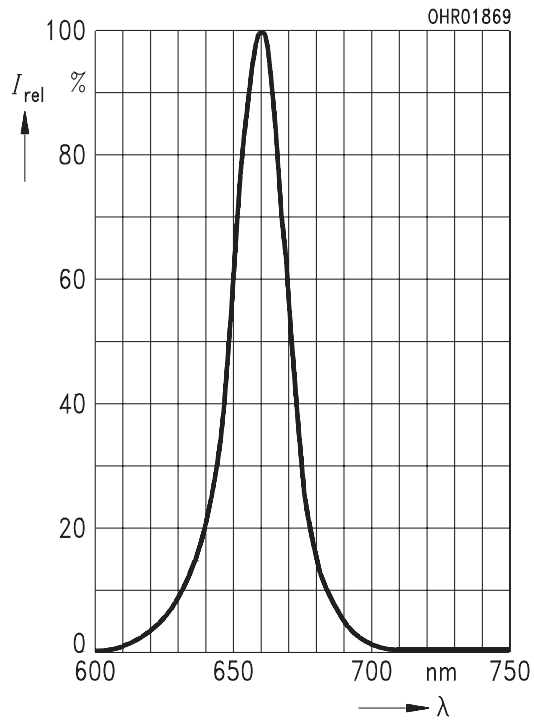

Figure 1. Relative Spectral Emission  $I_{rel} = f(\lambda)$

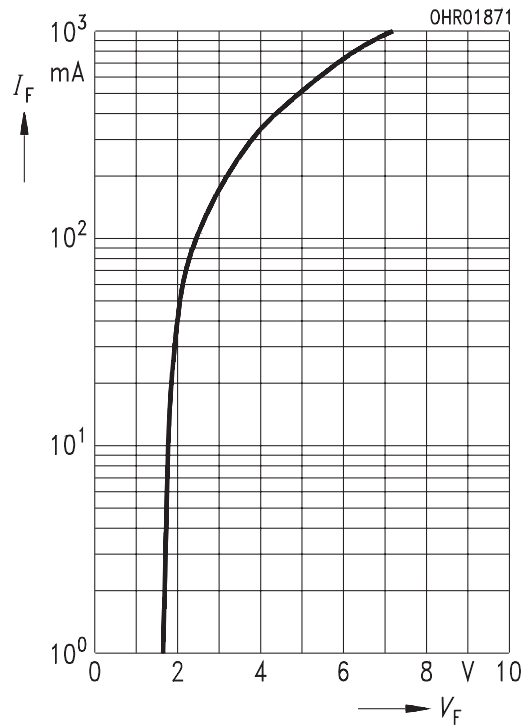

Figure 2. Forward Current  $I_F = f(V_F)$  single pulse, duration = 20  $\mu$ s

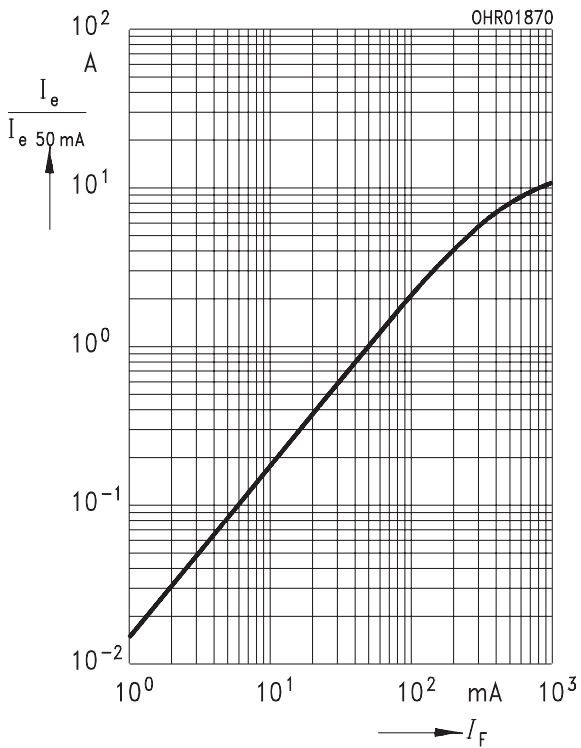

Figure 3. Relative Output Power,  $I_e/I_{e(50\text{ mA})} = f(I_F)$  single pulse, duration = 20  $\mu$ s

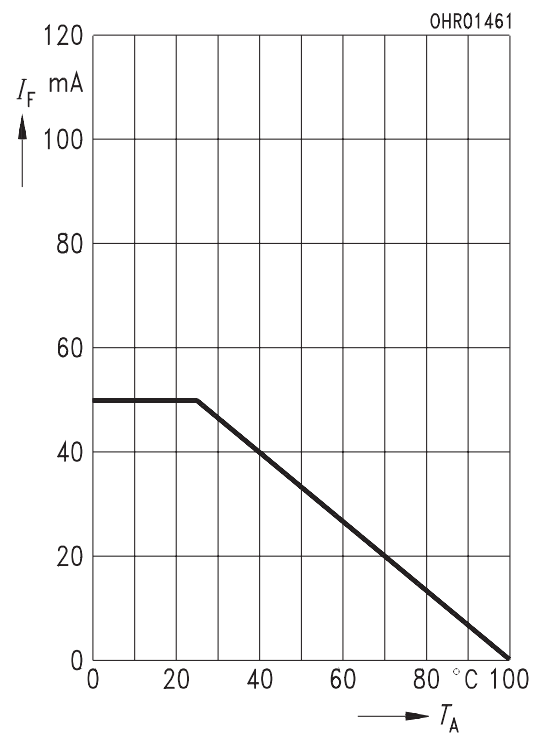
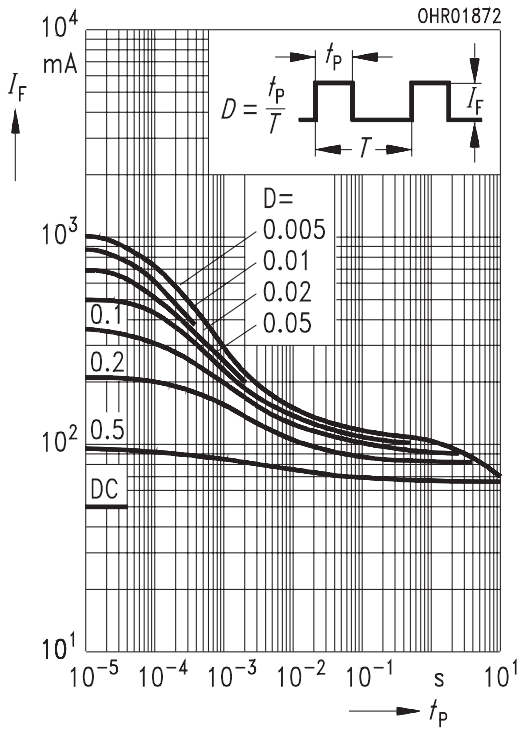
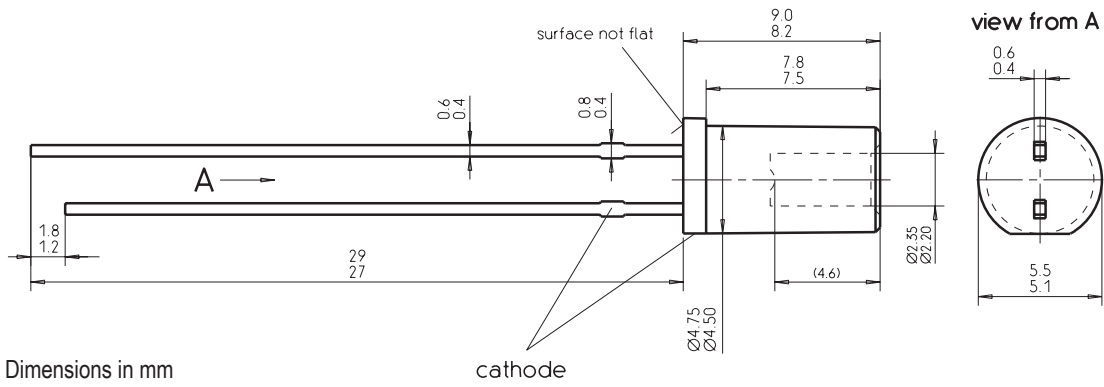

Figure 4. Maximum Permissible Forward Current,  $I_F = f(T_A)$ ,  $R_{thJA} = 450\text{ K/W}$



**Figure 5. Permissible Pulse Handling Capability,  $I_F = f(t_P)$ , duty cycle  $D =$  parameter,  $T_A = 25^\circ\text{C}$**

# Package Outlines



Dimensions in mm

Figure 6. SFH756

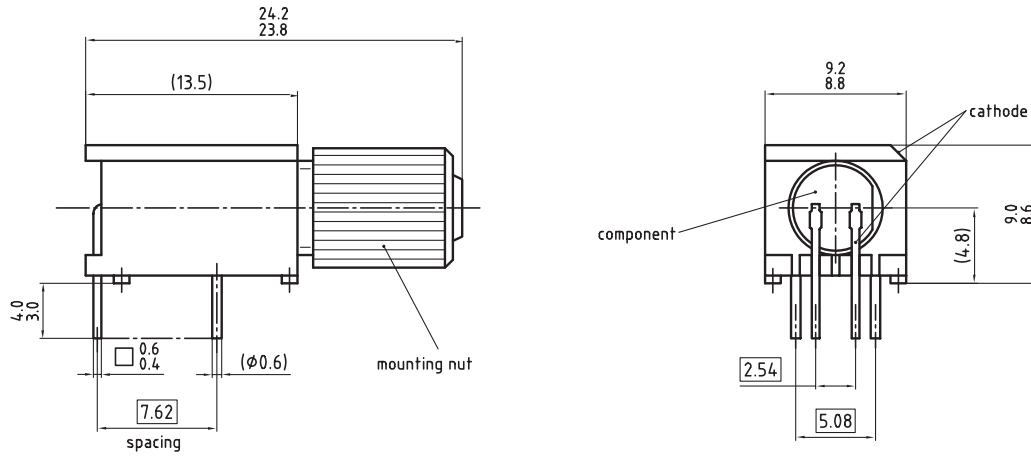

Dimensions in mm

Figure 7. SFH756V



## **Disclaimer**

The information herein is given to describe certain components and shall not be considered as a guarantee of characteristics.

Terms of delivery and rights to technical change reserved. We hereby disclaim any and all warranties, including but not limited to warranties of non-infringement, regarding circuits, descriptions and charts stated herein.

## **Warnings**

Due to technical requirements components may contain dangerous substances. For information on the types in question please contact your nearest Avago Technologies Office.

Avago Technologies Components may only be used in life-support devices or systems with the express written approval of Avago Technologies, if a failure of such components can reasonably be expected to cause the failure of that life-support device or system, or to affect the safety or effectiveness of that device or system. Life support devices or systems are intended to be implanted in the human body, or to support and/or maintain and sustain and/or protect human life. If they fail, it is reasonable to assume that the health of the user or other persons maybe endangered.

## **Information**

For further information on technology, delivery terms and conditions and prices please contact your nearest Avago Technologies Office ([www.avagotech.com](http://www.avagotech.com)).

For product information and a complete list of distributors, please go to our web site: [www.avagotech.com](http://www.avagotech.com)

Avago, Avago Technologies, and the A logo are trademarks of Avago Technologies, Limited in the United States and other countries.  
Data subject to change. Copyright © 2007 Avago Technologies Limited. All rights reserved.  
AV01-0715EN - June 30, 2007

**Avago**  
TECHNOLOGIES