



Chipsmall Limited consists of a professional team with an average of over 10 year of expertise in the distribution of electronic components. Based in Hongkong, we have already established firm and mutual-benefit business relationships with customers from,Europe,America and south Asia,supplying obsolete and hard-to-find components to meet their specific needs.

With the principle of “Quality Parts,Customers Priority,Honest Operation,and Considerate Service”,our business mainly focus on the distribution of electronic components. Line cards we deal with include Microchip,ALPS,ROHM,Xilinx,Pulse,ON,Everlight and Freescale. Main products comprise IC,Modules,Potentiometer,IC Socket,Relay,Connector.Our parts cover such applications as commercial,industrial, and automotives areas.

We are looking forward to setting up business relationship with you and hope to provide you with the best service and solution. Let us make a better world for our industry!



Contact us

Tel: +86-755-8981 8866 Fax: +86-755-8427 6832

Email & Skype: info@chipsmall.com Web: www.chipsmall.com

Address: A1208, Overseas Decoration Building, #122 Zhenhua RD., Futian, Shenzhen, China





SP6123 Evaluation Board Manual

FEATURES

- DC/DC Synchronous Buck Converter for Distributed Power Systems.
- Complete, Ready to Use Solutions For :
 - $V_{in} = 3V - 6V$
 - $V_{out} = 0.8V - V_{IN}$ (preset to 2.5V)
 - $I_{out} = 5.0A$ (*no air flow required*).
- High Efficiency: 86 to 95%
- Tight Line and Load Regulation
- Excellent Transient Response
- Components for Cost Effective Solution
- Overcurrent Protection
- High Switching Frequency for Small External Components.
- Low Power Shutdown

DESCRIPTION

The **SP6123 Evaluation Board** is designed to help users evaluate the performance of the SP6123 for using in distributed power systems. The SP6123 demo board operates over a wide input voltage range of 3V to 6V, and can deliver efficiencies over 90%. The SP6123 Evaluation Board is a complete power supply ready for use in applications where high stability, excellent transient response, high efficiency, power density and cost are critical concerns.

The Evaluation Board is a completely assembled and tested PCB with surface mount components and can be used in many distributed power systems.

BOARD SCHEMATIC AND LAYOUT

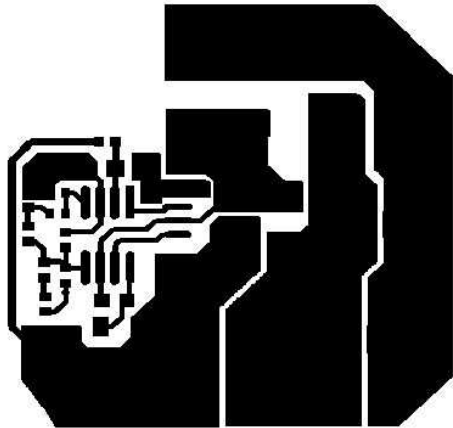

Top Layer

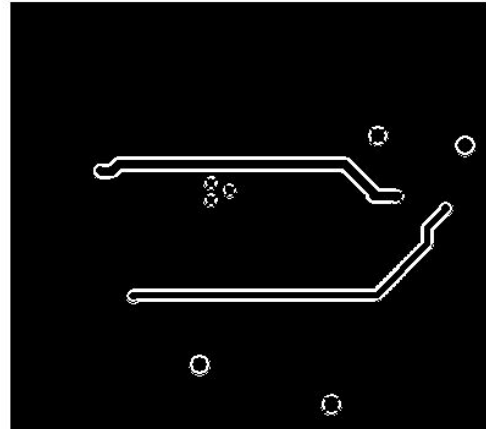

Bottom Layer

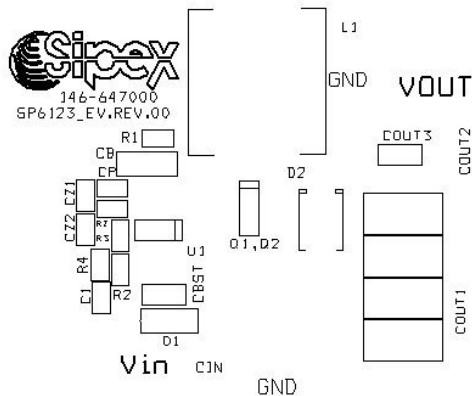

Silkscreen Top

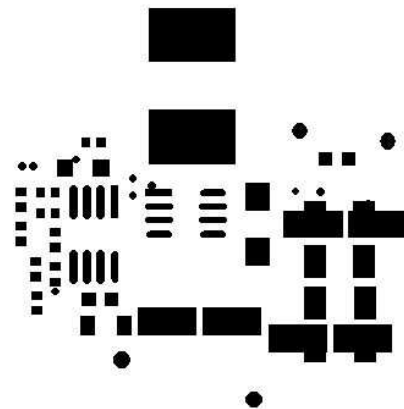

Soldermask Top

The SP6123 Eval Board is made of 2 oz copper dual layer PCB to provide improved noise immunity and minimize power losses. Components are placed on the topside of the PCB as shown. The ground pin of the IC together with all control grounds is brought to the ground of the output capacitor by the separate trace on the bottom layer and surrounded by the ground plane. The Vcc bypass capacitor CB is placed right near the Vcc pin. The traces connecting the feedback resistors are minimized. GH/GL traces are very close to the gates of the MOSFETs. The trace width of the loop connecting the inductor, output capacitors and MOSFETs is maximized.

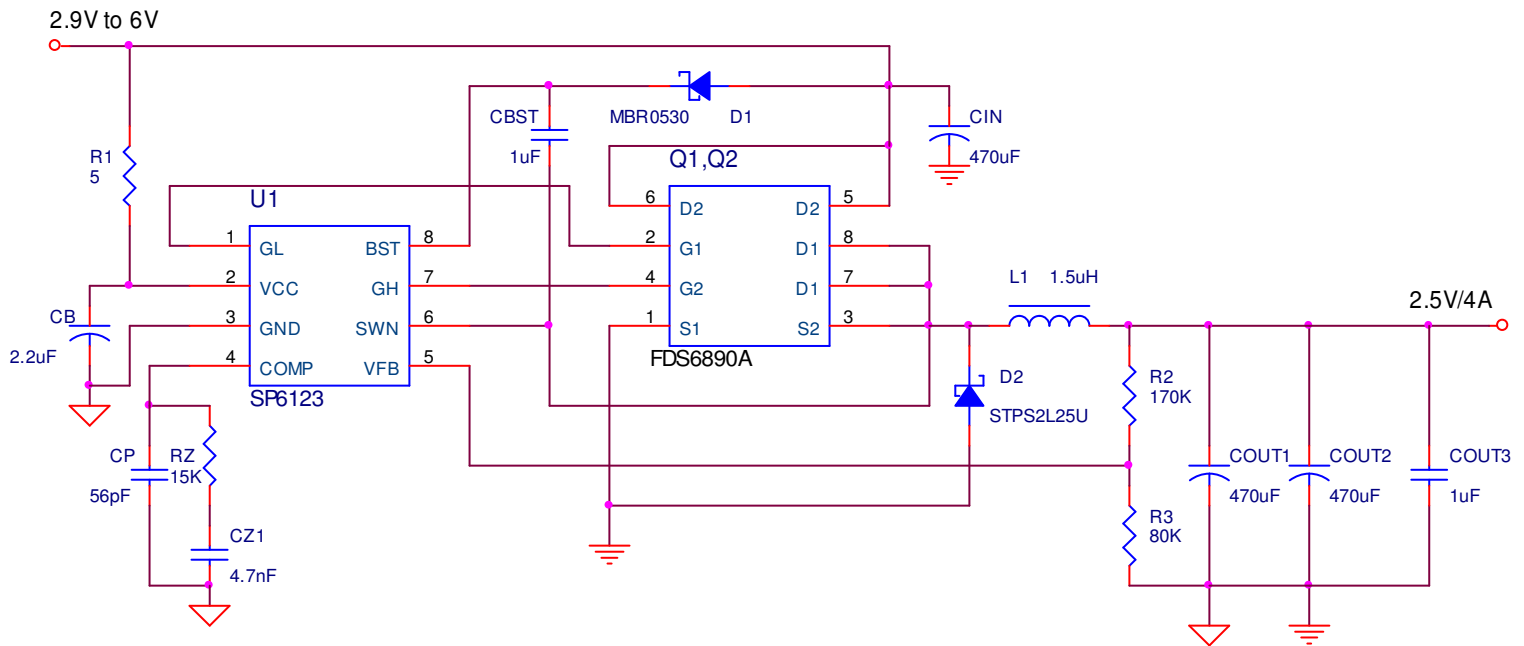

SP6123 Demo Board Schematic.

PROGRAM THE OUTPUT VOLTAGE

The resistor divider formed by R2 and R3 sets the output voltage. The output voltage is calculated using the following:

$$V_{OUT} = \left(\frac{R_2}{R_3} + 1 \right) V_{REF} ,$$

where $V_{REF} = 0.8V$.

For the SP6123 demo board where $V_{OUT} = 2.5V$. Choosing R3 equal to 80KΩ, then

$$R_2 = 170K \Omega$$

The considerations, tradeoffs and calculations required to select the power MOSFETs (Q_1 , Q_2), the inductor (L_1), the input and output capacitors C_{in} , C_{out1} and C_{out2} are discussed in detail in the SP6123 data sheet.

USING THE DEMO BOARD

To power the Demo Board, connect the input voltage to the V_{IN} and GND connectors located at the bottom of the board. The input voltage range is between 3V and 6V. Connect the load between V_{out} and GND connectors located at the right side of the board. The output voltage is preset to 2.5V. Measure the output ripple and voltage across the output capacitors with minimum ground lead. Connecting the COMP pin to the GND can disable this power supply.

DEMO BOARD CHARACTERISTICS (using SP6123ACN)

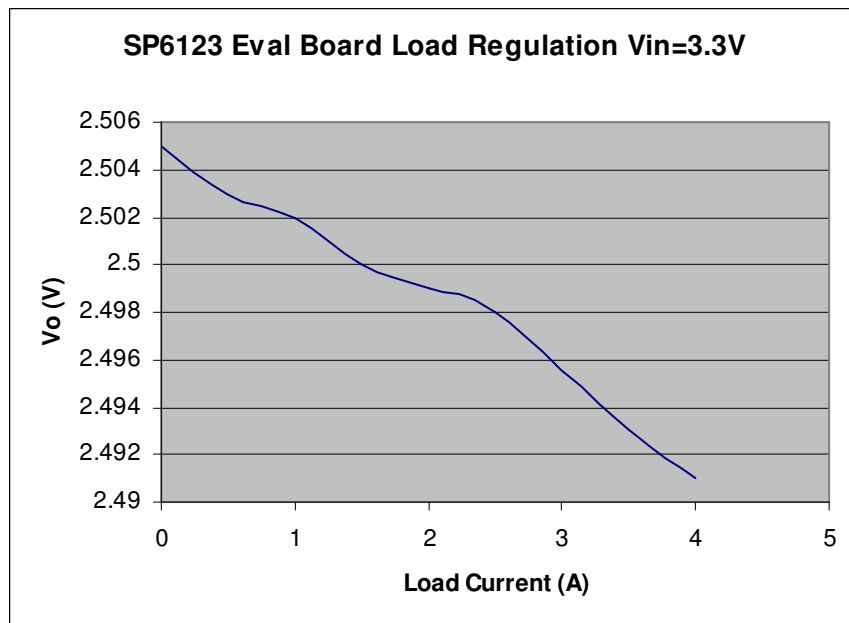
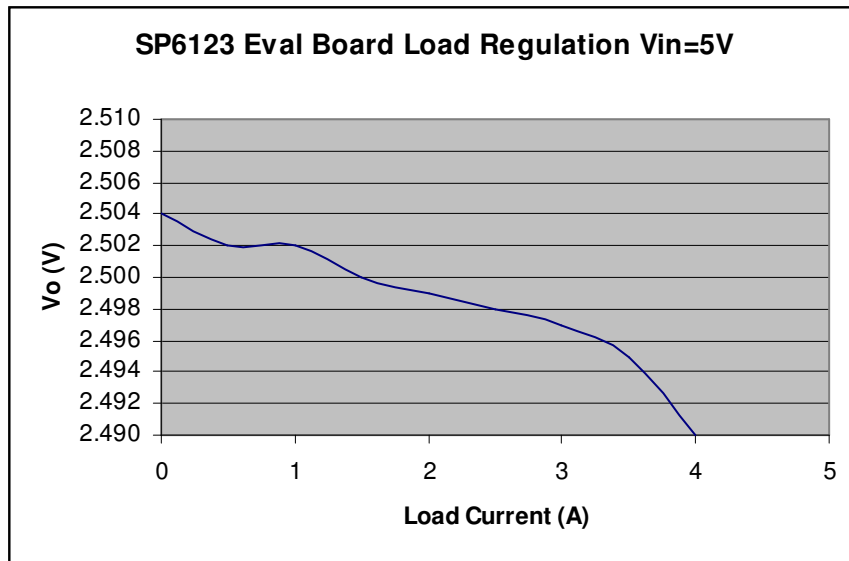
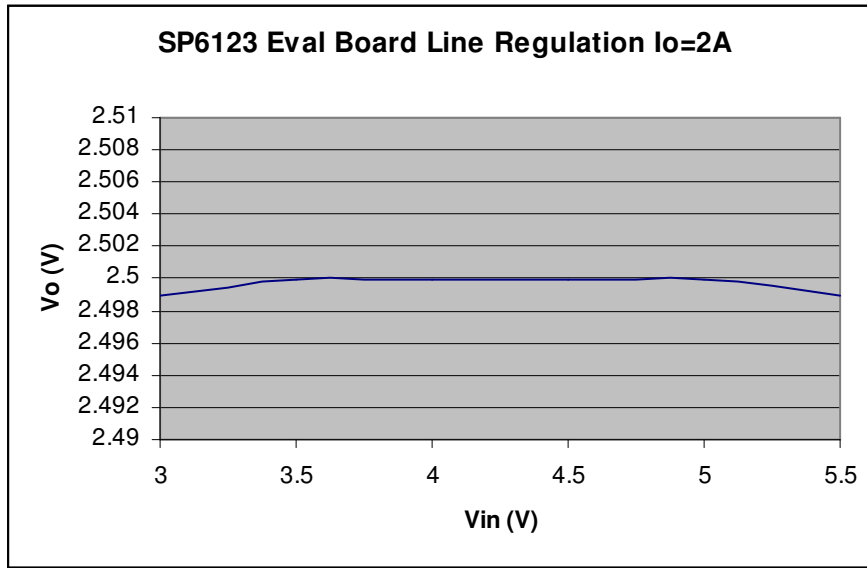

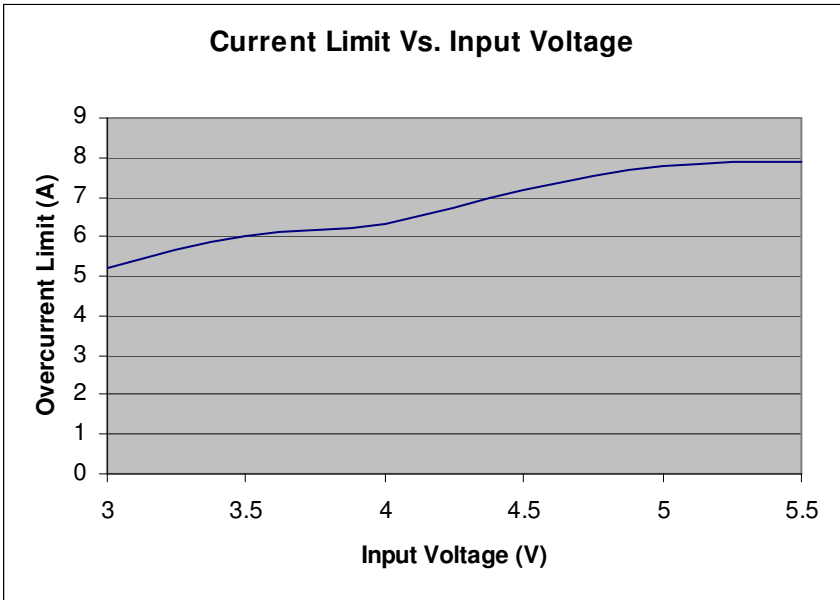
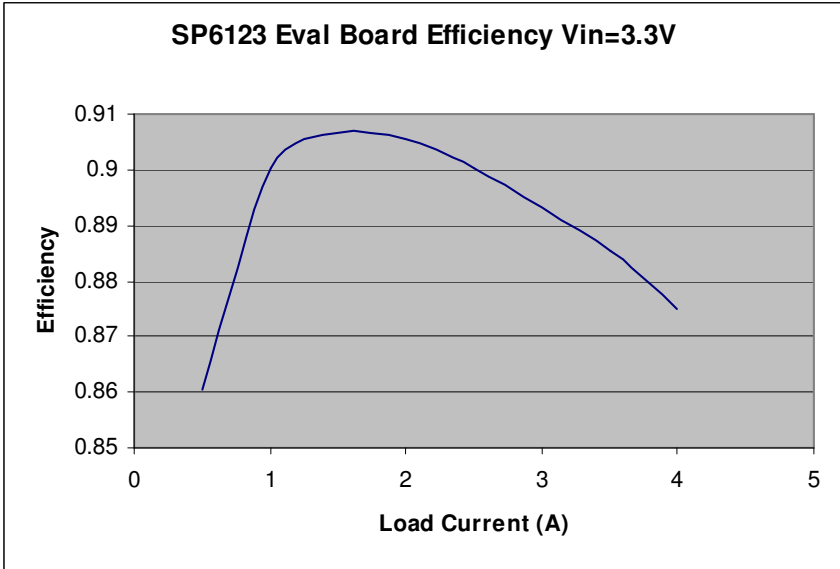
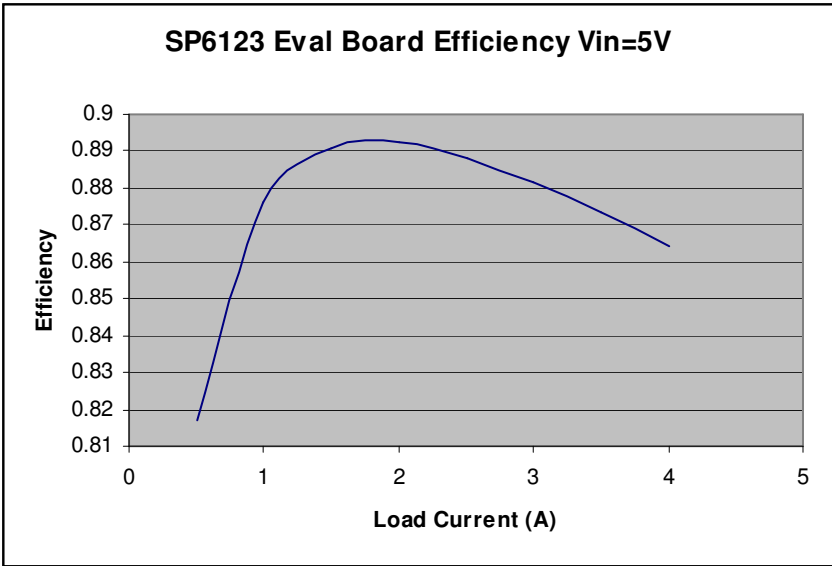

Output Ripple Voltage

Tek **Stop:** 25.0MS/s

38 Acqs

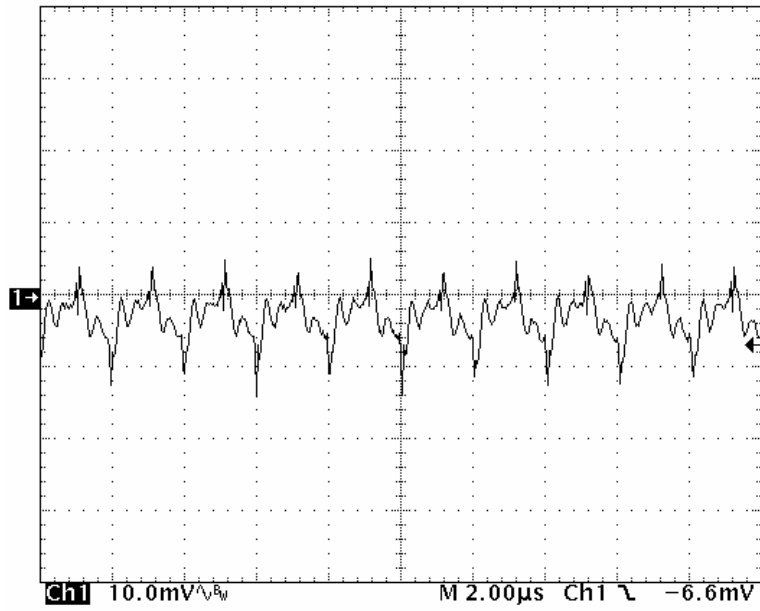

20 Mar 2002
17:39:00

$V_{in}=5V, I_o=2A$

Tek **Stop:** 25.0MS/s

94 Acqs

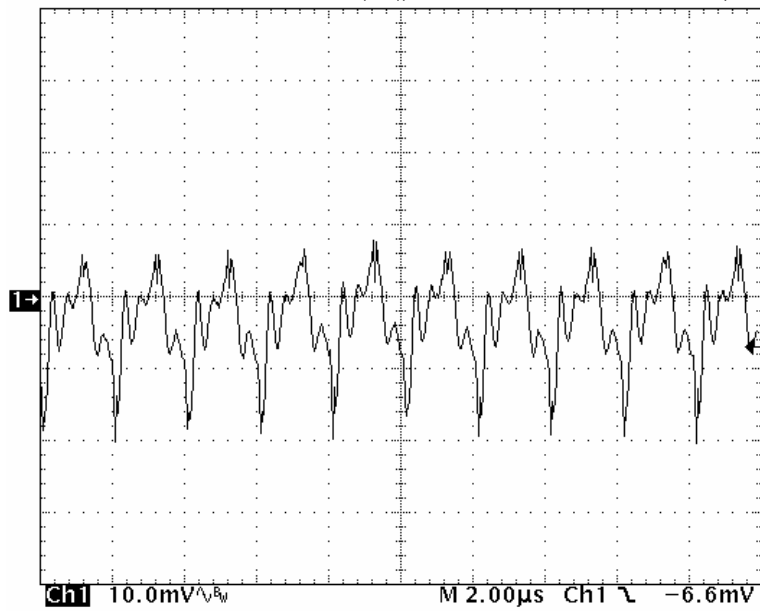

20 Mar 2002
17:39:50

$V_{in}=5V, I_o=4A$

Tek **Stop:** 25.0MS/s

84 Acqs

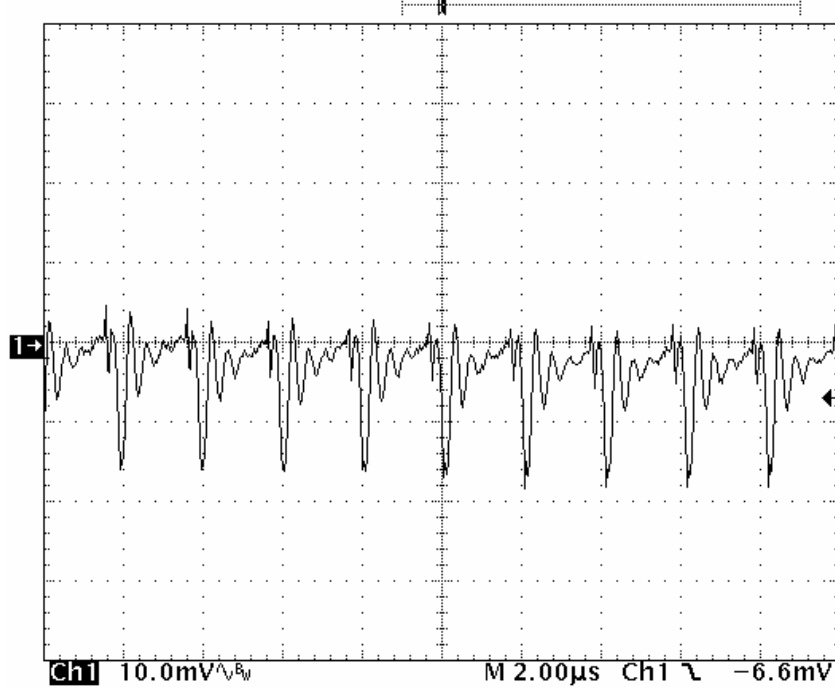

20 Mar 2002
17:40:47

$V_{in}=3.3V, I_o=4A$

Tek **Stop:** 25.0MS/s

41 Acqs

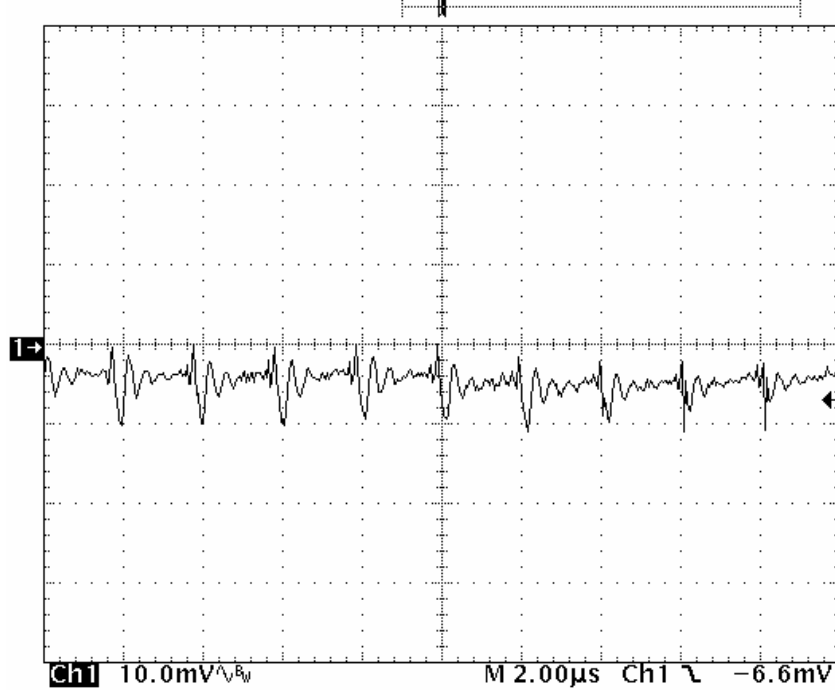

20 Mar 2002
17:42:38

$V_{in}=3.3V, I_o=2A$

Startup Waveform

Tek **Stop**: Single Seq 100kS/s

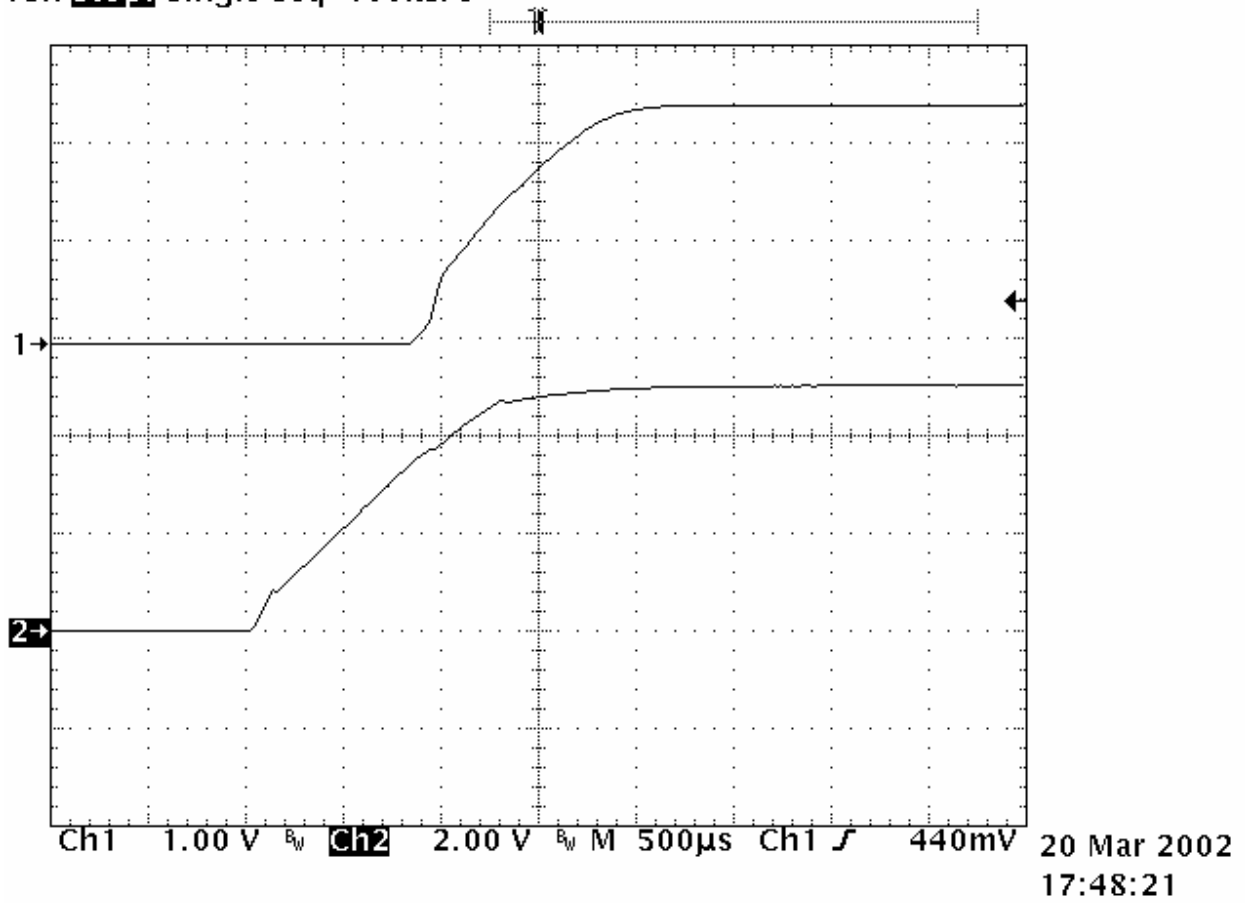

Ch1: Vo, Ch2: Vin. Io=2A

BILL OF MATERIALS

Item	Quantity	Reference	Part description	Manufacturer	Manufacturer P/N/ PACKAGE
1	1	CB	Capacitor Ceramic 2.2uF/10V/X5R/10%	TDK Corporation	C2012X5R1A225K 0805
2	1	CP	Capacitor Ceramic 56pF/50V/COG/5%	TDK Corporation	C1608COG1H560J 0603
3	1	CZ1	Capacitor Ceramic 4.7nF/50V/X7R/10%	TDK Corporation	C1608X7R1H472K 0603
4	2	CBST,COUT3	Capacitor Ceramic 1uF/10V/X5R/10%	TDK Corporation	C1608X5R1A105K 0603
5	1	CIN	POSCAP 470uF/6.3V/20%	SANYO	6TPB470M
6	2	COUT1,COUT2	POSCAP 470uF/4V/20%	SANYO	4TPB470M
7	1	D1	Diode Schottky 30V/0.5A	VISHAY	MBR0530 SOD-123
8	1	D2	Diode Schottky 25V/2.0A	ST Microelectronics	STPS2L25U
9	1	L1	Inductor 1.5uH/0.01Ohm DCR	Coil Craft	DO3316P-152
10	1	Q1,Q2(dual)	MOSFET 18mOhm/7.5A	Fairchild	FDS6890A SO-8
11	1	R2	Resistor 170K/63mW/1%	AVX Corporation	CR10--1703F-H/ 0603
12	1	R3	Resistor 80K/63mW/1%	AVX Corporation	CR10--803F-H/ 0603
13	1	RZ	Resistor 15K/63mW/5%	AVX Corporation	CR10-153J-H/ 0603
14	1	R1	Resistor 5 Ohm/63mW/5%	AVX Corporation	CR21-050J-H/ 0603
15	1	U1	SYNCH. BUCK CONTROLLER	SIPEX Corporation	SP6123ACN /SOIC-8