



Chipsmall Limited consists of a professional team with an average of over 10 year of expertise in the distribution of electronic components. Based in Hongkong, we have already established firm and mutual-benefit business relationships with customers from,Europe,America and south Asia,supplying obsolete and hard-to-find components to meet their specific needs.

With the principle of "Quality Parts,Customers Priority,Honest Operation,and Considerate Service",our business mainly focus on the distribution of electronic components. Line cards we deal with include Microchip,ALPS,ROHM,Xilinx,Pulse,ON,Everlight and Freescale. Main products comprise IC,Modules,Potentiometer,IC Socket,Relay,Connector.Our parts cover such applications as commercial,industrial, and automotives areas.

We are looking forward to setting up business relationship with you and hope to provide you with the best service and solution. Let us make a better world for our industry!



Contact us

Tel: +86-755-8981 8866 Fax: +86-755-8427 6832

Email & Skype: info@chipsmall.com Web: www.chipsmall.com

Address: A1208, Overseas Decoration Building, #122 Zhenhua RD., Futian, Shenzhen, China





SP6682UEB Evaluation Board Manual

- Low-profile, inductor-less regulator
- Automatic Transition from X1.5 to X2 mode for highest efficiency
- PWM dimming control
- >100mA output current @ 2.8V input
- Less than 1uA shutdown current
- 10 pin MSOP or 10 pin 3x3mm MLP package options

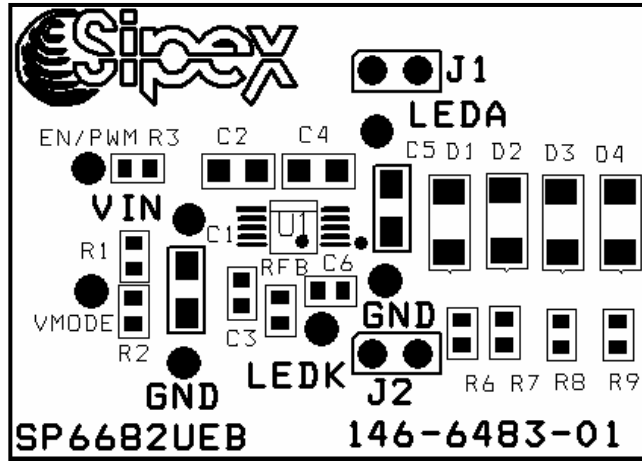

SP6682 Evaluation Board Schematics

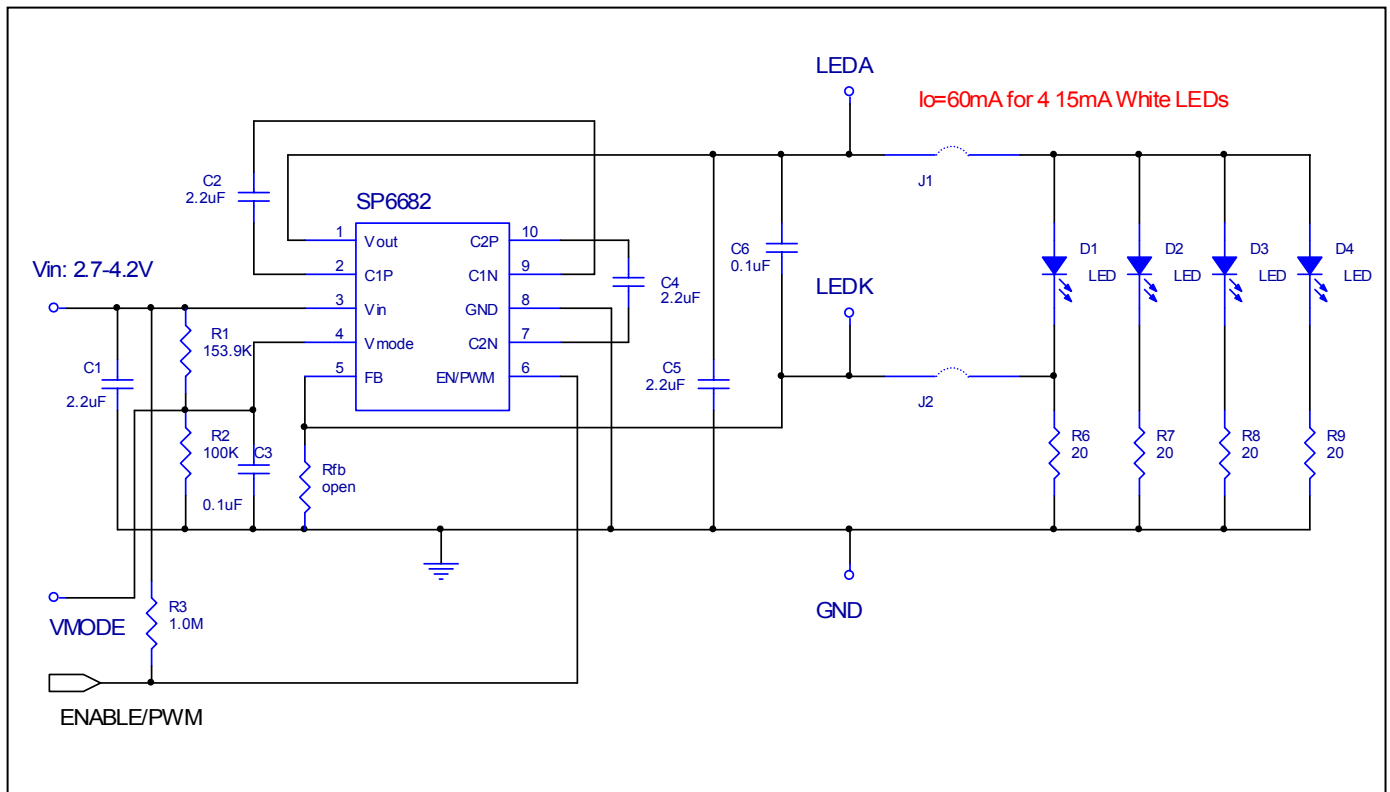

USING THE EVALUATION BOARD

1) Powering Up the SP6682 Circuit

The SP6682 Evaluation Board can be powered from inputs from a +2.7V to +5.5V battery or a power supply. Connect with short leads directly to the “Vin” and “GND” posts. Monitor the Output Voltage and connect the Load between the “LEDA” post and the “GND” post.

2) Using the Jumper and posts

There are two jumpers (J1 and J2) and seven posts on the Eval Board. The output of SP6682 was connected to the four 15mA white LEDs by the two jumpers as default. If the customer has his own white LED load module, they can plug the two terminals of their load to the “LEDA” and “LEDK” posts.

3) Selecting the Bias Resistor

The bias resistor could be estimated by (1)

$$R_B = \frac{V_{FB}}{I_{LED}} = \frac{0.3}{I_{LED}} \quad (1)$$

Where I_{LED} is the operating current of the white LEDs.

4) Selecting of V_{mode} and Divider Resistor

SP6682 can automatically change from X1.5 mode to X2 mode for highest efficiency. To use this feature, divider resistors should be chosen according to the specific application. The guideline for divider resistor selections is as follows.

For high input voltage, the SP6682 will work in X1.5 mode, when the input voltage drops to V_{mode} threshold voltage, it will switch to X2 mode automatically.

The V_{mode} threshold voltage could be calculated by (2)

$$V_{th} = \frac{V_F + 0.3 + m \cdot I_{LED} \cdot R_{out}}{1.5} \quad (2)$$

Where V_F and m are the forward voltage and number of the white LEDs, R_{out} is the output resistance of the SP6682.

To keep performance constant with different V_{mode} and to reduce divider current, fix R_2 as 100Kohm, the R_1 could be selected by (3)

$$R_1 = \frac{(V_F + 0.3 + m \cdot I_{LED} \cdot R_{out} - 1.875) \cdot R_2}{1.875} \quad (3)$$

For detailed derivation of the above equations, please refer to the data sheet. Selecting of bias resistor, divider resistor and efficiency estimation could be done Using the SP6682 CAD file provided by Sipex.

5) Selecting of Capacitors

Ceramic capacitors are used on the eval board due to their inherently low ESR, which will help produce low peak to peak output ripple, and reduce high frequency spikes.

Selection of the fly capacitor is a trade-off between the output voltage ripple and the output current capability. Decreasing the fly capacitor will reduce the output voltage ripple because less charge will be delivered to the output capacitor. However, smaller fly capacitor leads to larger output resistance, thus decrease the output current capability and the circuit efficiency.

In the eval board, the input, output and fly capacitors are selected as 2.2uF ceramic capacitors. Input and output ripple could be further reduced by using larger low ESR input and output capacitor.

6) Brightness Control

Obvious dimming control could be achieved by applying a PWM control signal to the ENABLE/PWM pin. The PWM signal should have a repetition rate of at least 60Hz to prevent flicker but should not exceed 200Hz to allow the capacitors to discharge.

Please note that it is important to make the PWM voltage be V_{in} or GND voltages

POWER SUPPLY DATA

For a 4x15mA White LEDs application, in which the output current is 60mA, the power supply data is provided as Fig 1 to Fig 3. Figure 1 shows the input and output voltage ripple when the input voltage is 2.7V (SP6682 is in X2 mode), Figure 2 shows the input and output voltage ripple curve when the input voltage is 3.2V (SP6682 is in X1.5 mode). Figure 3. Shows the typical efficiency curve in the input voltage range. Note, the power supply data was taken at $C_1=C_5=4.7\mu\text{F}$, $C_2=C_4=1\mu\text{F}$, $C_3=C_6=0.1\mu\text{F}$ condition. Channel 1 is the input ripple and the channel 2 is the output ripple. Other applications, such as 80mA output current application (4 20mA white LEDs in parallel), have the similar characteristic.

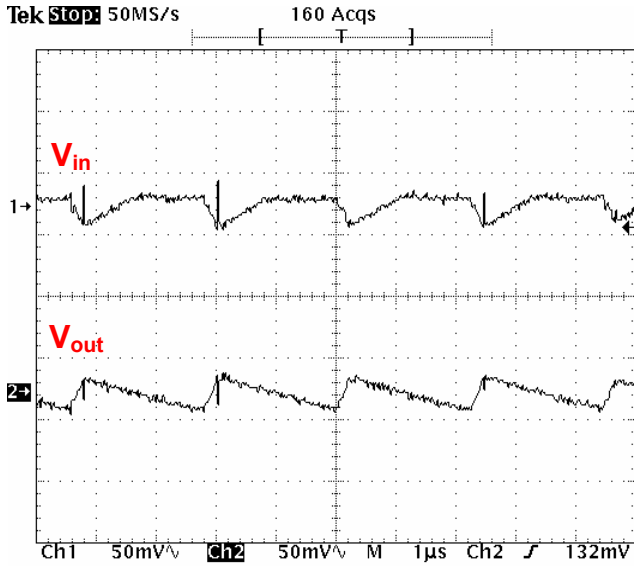

Figure 1. X2 Mode Voltage Ripple @ 2.7V
($C_1=C_5=4.7\mu\text{F}$, $C_2=C_4=1\mu\text{F}$)

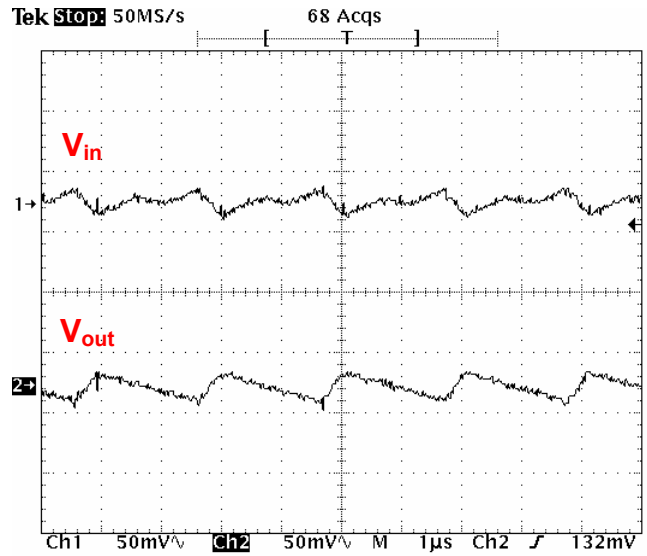

Figure 2. X1.5 Mode Voltage Ripple @ 3.2V
($C_1=C_5=4.7\mu\text{F}$, $C_2=C_4=1\mu\text{F}$)

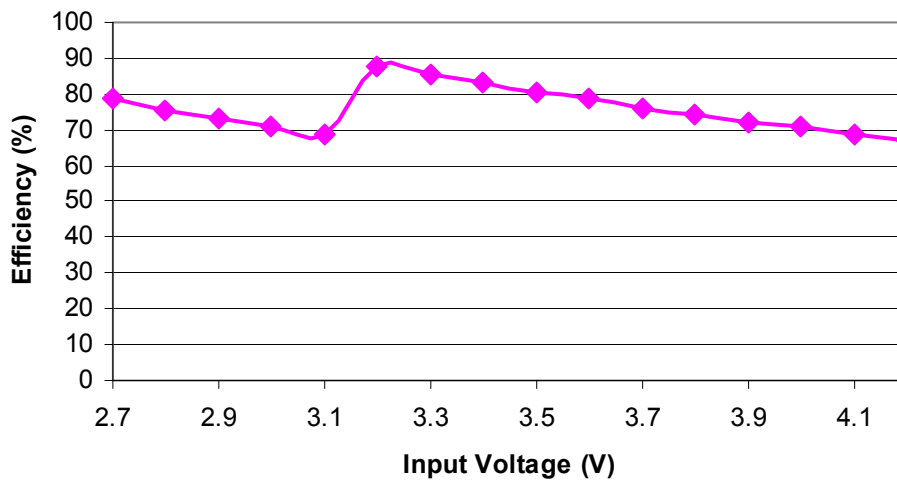

Figure 3. Efficiency vs input voltage

Evaluation Board Layout

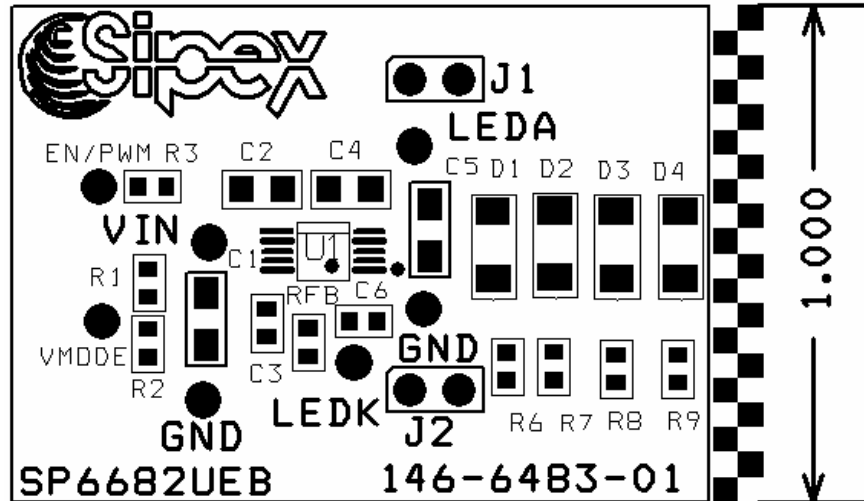

FIGURE 4: SP6682 COMPONENT PLACEMENT

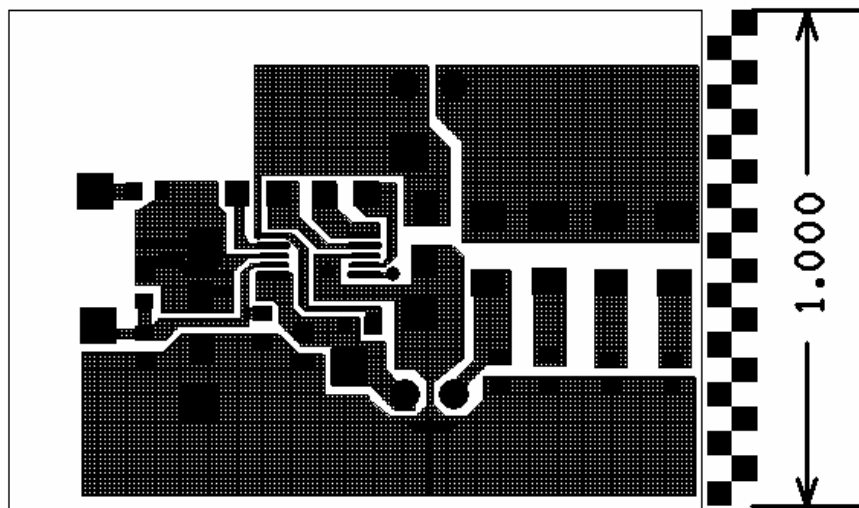

FIGURE 5: SP6682 PC LAYOUT TOP SIDE

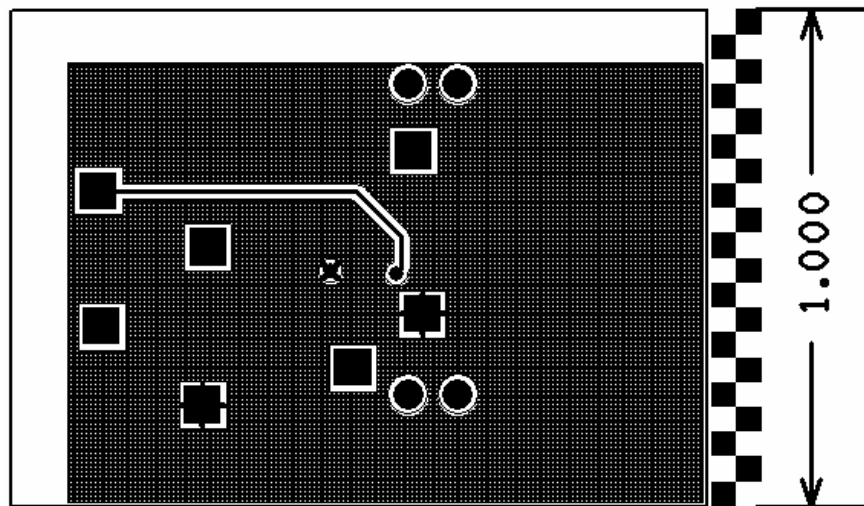

FIGURE 6: SP6682 PC LAYOUT BOTTOM SIDE

TABLE1: SP6682 BILL OF MATERIALS

SP6682 Evaluation Board List of Materials						
Ref. Des.	Qty.	Manufacturer	Part Number	Layout Size LxWxH	Component	Vendor
	1	Sipex Corp.		1"x1.5"	SP6682 Eval PC Board	Sipex 978-667-8700
U1	1	Sipex Corp.	SP6682	MSSOP-10	10 PIN High Efficiency Charge Pump Regulator	Sipex 978-667-8700
C1,C2,C4,C5	4	TDK Corp	TDKC2012X5R1A225K	805	2.2uF/10V/X5R/10% Ceramic	TDK 847-803-6100
C3,C6	2	TDK Corp		603	0.1uF/10V/X7R/10% Ceramic	TDK 847-803-6100
D1-D4	4	LUMEX	SML-LX2832UWC-TR		White LED	800-Digi-Key
R1	1			603	153.9K/ 63mW/1%	800-Digi-Key
R2	1			603	100K/ 63mW/1%	800-Digi-Key
R3	1			603	1.0M/ 63mW/5%	800-Digi-Key
R6-R9	4			603	20.0 Ohm/ 63mW/5%	800-Digi-Key
Rfb					Open	
TP	7	Mill-Max	0300-115-01-4727100	.042 Dia	Test Point Female Pin	800-Digi-Key
J1,J2	1	Sullins	PTC36SAAN	.23x.12	2-Pin Header	800-Digi-Key

ORDERING INFORMATION

Part Number	Temperature Range	Package Type
SP6682UEB.....	-40°C to +85°C.....	SP6682 Evaluation Board