



Chipsmall Limited consists of a professional team with an average of over 10 year of expertise in the distribution of electronic components. Based in Hongkong, we have already established firm and mutual-benefit business relationships with customers from,Europe,America and south Asia,supplying obsolete and hard-to-find components to meet their specific needs.

With the principle of “Quality Parts,Customers Priority,Honest Operation,and Considerate Service”,our business mainly focus on the distribution of electronic components. Line cards we deal with include Microchip,ALPS,ROHM,Xilinx,Pulse,ON,Everlight and Freescale. Main products comprise IC,Modules,Potentiometer,IC Socket,Relay,Connector.Our parts cover such applications as commercial,industrial, and automotives areas.

We are looking forward to setting up business relationship with you and hope to provide you with the best service and solution. Let us make a better world for our industry!



Contact us

Tel: +86-755-8981 8866 Fax: +86-755-8427 6832

Email & Skype: info@chipsmall.com Web: www.chipsmall.com

Address: A1208, Overseas Decoration Building, #122 Zhenhua RD., Futian, Shenzhen, China





SP7653 Evaluation Board Manual

- Easy Evaluation for the SP7653ER 12V Input, 0 to 3A Output Synchronous Buck Converter
- Built in Low Rds(on) Power FETs
- UVLO Detects Both VCC and VIN
- Highly Integrated 1.3MHz Design, Minimal Components
- High Efficiency: 90%
- Feature Rich: UVIN, Programmable Softstart, External VCC Supply and Output Dead Short Circuit shutdown Protection

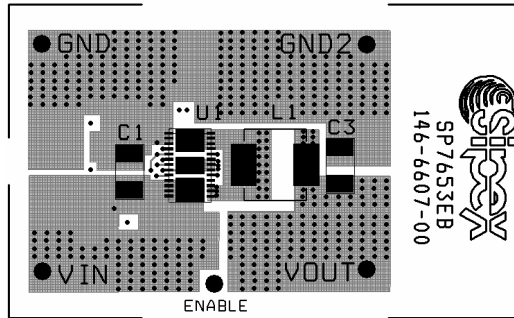

SP7653EB SCHEMATIC

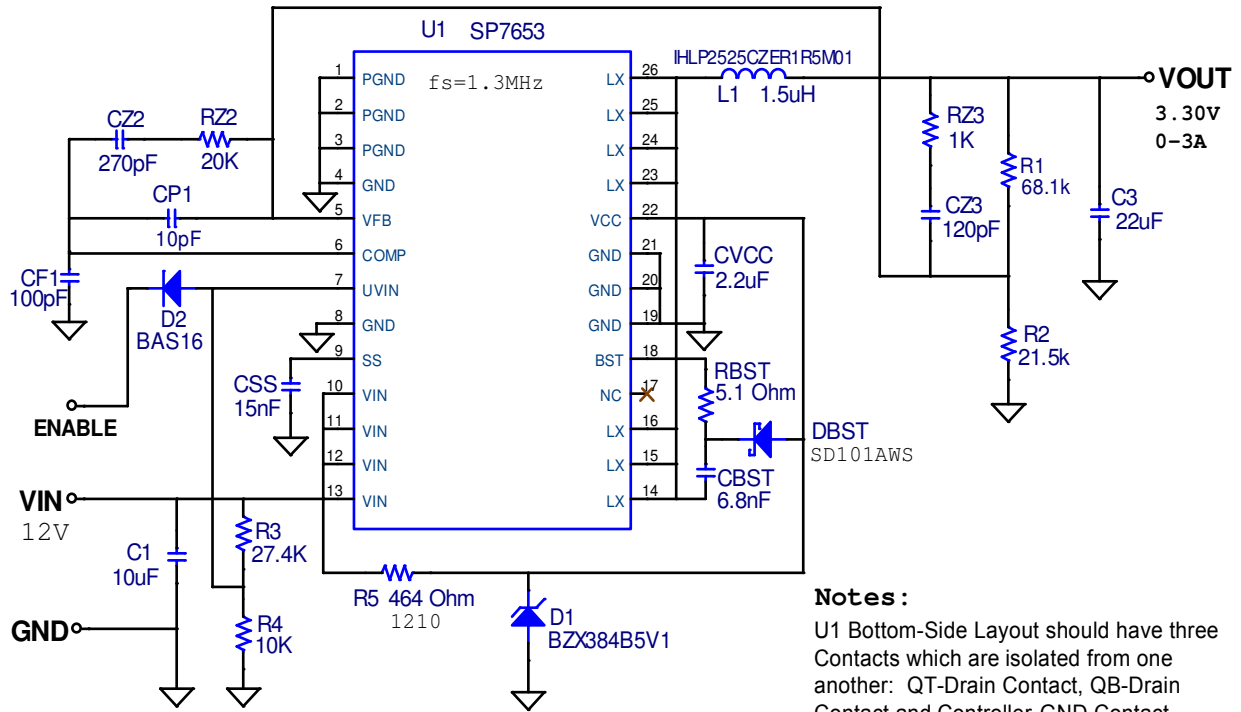

Notes:
 U1 Bottom-Side Layout should have three Contacts which are isolated from one another: QT-Drain Contact, QB-Drain Contact and Controller-GND Contact.
 ALL RESISTORS & CAPACITORS ARE SIZE 0603 UNLESS OTHERWISE SPECIFIED.

USING THE EVALUATION BOARD

1) Powering Up the SP7653EB Circuit

Connect the SP7653 Evaluation Board with an external +12V power supply. Connect with short leads and large diameter wire directly to the “VIN” and “GND” posts. Connect a Load between the VOUT and GND2 posts, again using short leads with large diameter wire to minimize inductance and voltage drops.

2) Measuring Output Load Characteristics

It's best to GND reference scope and digital meters using the Star GND post in the center of the board. VOUT ripple can best be seen touching probe tip to the pad for C3 and scope GND collar touching Star GND post – avoid a GND lead on the scope which will increase noise pickup.

3) Using the Evaluation Board with Different Output Voltages

While the SP7653 Evaluation Board has been tested and delivered with the output set to 3.30V, by simply changing one resistor, R2, the SP7653 can be set to other output voltages. The relationship in the following formula is based on a voltage divider from the output to the feedback pin VFB, which is set to an internal reference voltage of 0.80V. Standard 1% metal film resistors of surface mount size 0603 are recommended.

$$V_{out} = 0.80V (R1 / R2 + 1) \Rightarrow R2 = R1 / [(V_{out} / 0.80V) - 1]$$

Where R1 = 68.1K Ω and for Vout = 0.80V setting, simply remove R2 from the board. Furthermore, one could select the value of R1 and R2 combination to meet the exact output voltage setting by restricting R1 resistance range such that 50K Ω \leq R1 \leq 100K Ω for overall system loop stability.

Note that since the SP7653 Evaluation Board design was optimized for 12V down conversion to 3.30V, changes of output voltage and/or input voltage will alter performance from the data given in the Power Supply Data section. In addition, the SP7653ER provides short circuit protection by sensing Vout at GND.

POWER SUPPLY DATA

The SP7653ER is designed with a very accurate 1.0% reference over line, load and temperature. Figure 1 data shows a typical SP7653 Evaluation Board Efficiency plot, with efficiencies to 90% and output currents to 3A. SP7653ER Load Regulation is shown in Figure 2 of only 0.1% change in output voltage from no load to 3A load. Figures 3 and 4 illustrate a 1.5A to 3A and 0A to 3A Load Step. Start-up Response in Figures 5 and 6 shows a controlled start-up with different output load behavior when power is applied where the input current rises smoothly as the Softstart ramp increases. In Figure 7 the SP7653ER is configured for hiccup mode in response to an output dead short circuit condition and will Softstart until the over-load is removed. Figure 8 show output voltage ripple less than 10mV at no load to 3A load.

While data on individual power supply boards may vary, the capability of the SP7653ER of achieving high accuracy over a range of load conditions shown here is quite impressive and desirable for accurate power supply design.

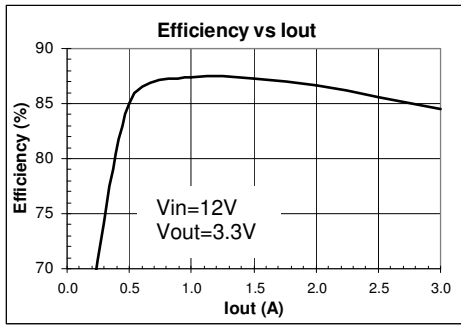

Figure 1. Efficiency Vs Load

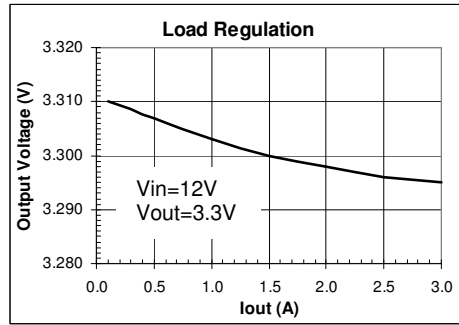

Figure 2. Load Regulation

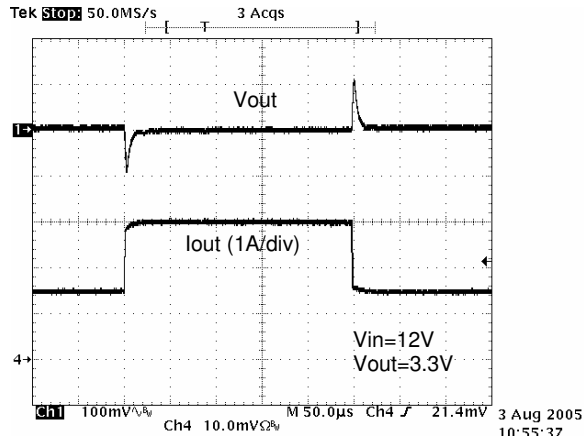

Figure 3. Load Step Response: 1.5->3A

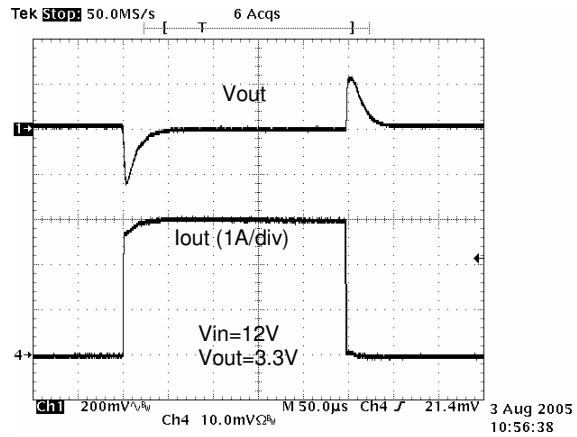

Figure 4. Load Step Response: 0->3A

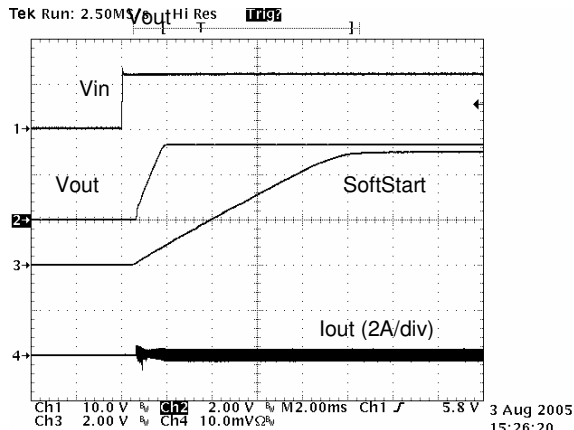

Figure 5. Start-Up Response: No Load

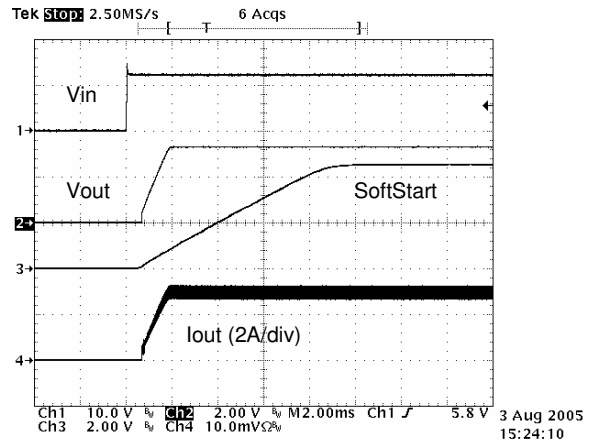

Figure 6. Start-Up Response: 3.0A Load

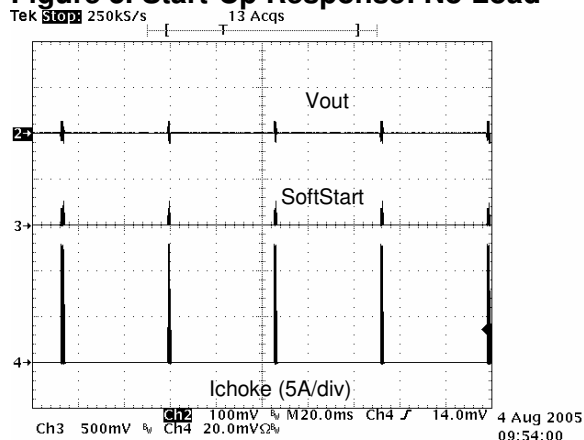

Figure 7. Output Load Short Circuit

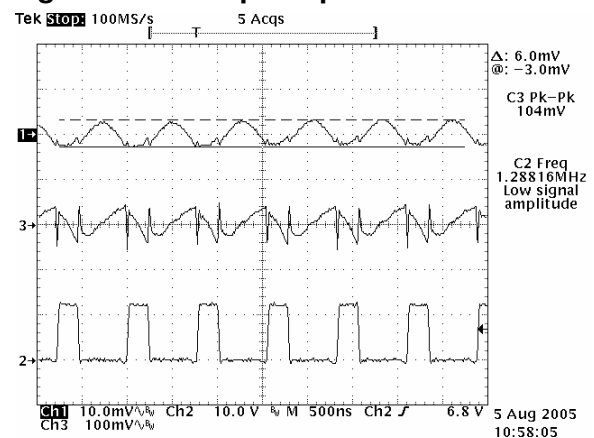

Figure 8. Output Ripple

PC LAYOUT DRAWINGS

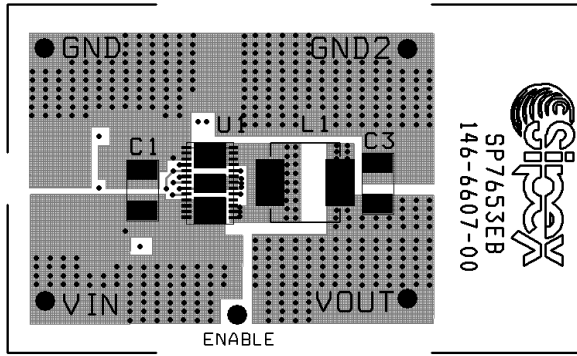

Figure 9. Top Side & Component Placement

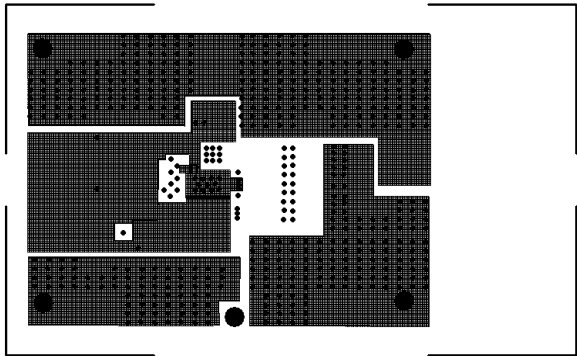

Figure 10. PCB Layout 2nd Layer Side

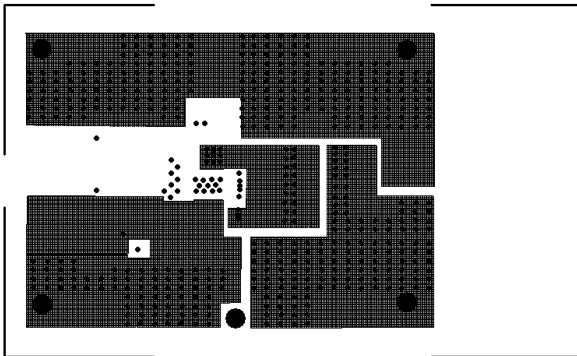

Figure 11. PCB Layout 3rd Layer Side

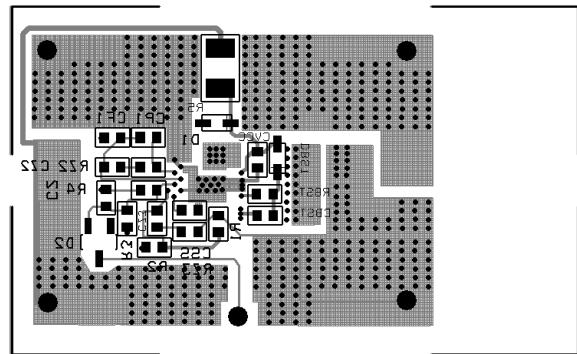

Figure 12. Bottom Side & Component Placement

SP7653EB List of Materials

SP7653 Vin=12V Evaluation Board Rev. 00 List of Materials								10/05/2005
Line No.	Ref. Des.	Qty.	Manuf.	Manuf. Part Number	Layout Size	Component	Vendor Phone Number	
1	PCB	1	Sipex	146-6607-00	1.75"X2.75"	SP7653EB	www.sipex.com	
2	U1	1	Sipex	SP7653ER	DFN-26	2-FETs Buck Ctrl	www.sipex.com	
3	D1	1	Vishay	BZX384B5V1	SOD-323	5.1V, 200mW Zener	www.vishay.com	
4	D2	1	Vishay	BAS16	SOT-23	Small signal fast switching diode	www.vishay.com	
5	DBST	1	Vishay	SD101AWS	SOD-323	15mA Schottky Diode	www.vishay.com	
6	L1	1	Vishay	IHLP-2525CZER1R5M01	6.86X6.47mm	1.5uH Coil 9A 15mohm	www.vishay.com	
7	C1	1	TDK	C3225X5R1E106M	1210	10uF Ceramic X5R 25V	www.tdk.com	
				C3216X5R1C106M	1206	10uF Ceramic X5R 16V	www.tdk.com	
8	C3	1	TDK	C3225X5R1C226M	1210	22uF Ceramic X5R 16V	www.tdk.com	
9	CVCC	1	TDK	C1608X5R1A225K	0603	2.2uF Ceramic X5R 10V	www.tdk.com	
10	CBST	1	TDK	C1608X7R1H682K	0603	6,800pF Ceramic X7R 50V	www.tdk.com	
11	CSS	1	TDK	C1608X7R1H153K	0603	15,000pF Ceramic X7R 50V	www.tdk.com	
12	CP1	1	TDK	C1608COG1H100J	0603	10pF Ceramic COG 50V	www.tdk.com	
13	CZ2	1	TDK	C1608COG1H271J	0603	270pF Ceramic COG 50V	www.tdk.com	
14	CZ3	1	TDK	C1608COG1H121J	0603	120pF Ceramic COG 50V	www.tdk.com	
15	CF1	1	TDK	C1608COG1H101J	0603	100pF Ceramic COG 50V	www.tdk.com	
16	RZ2	1	Vishay	CRCW06032002F	0603	20.0K Ohm Thick Film Res 1%	www.vishay.com	
17	R2	1	Vishay	CRCW06032152F	0603	21.5K Ohm Thick Film Res 1%	www.vishay.com	
18	RZ3	1	Vishay	CRCW06031001F	0603	1.0K Ohm Thick Film Res 1%	www.vishay.com	
19	R1	1	Vishay	CRCW06036813F	0603	68.1K Ohm Thick Film Res 1%	www.vishay.com	
21	R3	1	Vishay	CRCW06032742F	0603	27.4K Ohm Thick Film Res 1%	www.vishay.com	
20	R4	1	Vishay	CRCW06031002F	0603	10K Ohm Thick Film Res 1%	www.vishay.com	
22	RBST	1	Vishay	CRCW06035R11F	0603	5.11 Ohm Thick Film Res 1%	www.vishay.com	
23	R6	1	Vishay	CRCW1210464RJ	1210	464 Ohm Thick Film Res 5%	www.vishay.com	
24	VIN,VOUT,GND,GND2,ENABLE	5	Vector Electronic	K24C/M	.042 Dia	Input/Output Terminal Posts	800-344-4539	

ORDERING INFORMATION

Model	Temperature Range	Package Type
SP7653EB.....	-40°C to +85°C.....	SP7653 Evaluation Board
SP7653ER.....	-40°C to +85°C.....	26-pin DFN