



Chipsmall Limited consists of a professional team with an average of over 10 year of expertise in the distribution of electronic components. Based in Hongkong, we have already established firm and mutual-benefit business relationships with customers from,Europe,America and south Asia,supplying obsolete and hard-to-find components to meet their specific needs.

With the principle of "Quality Parts,Customers Priority,Honest Operation,and Considerate Service",our business mainly focus on the distribution of electronic components. Line cards we deal with include Microchip,ALPS,ROHM,Xilinx,Pulse,ON,Everlight and Freescale. Main products comprise IC,Modules,Potentiometer,IC Socket,Relay,Connector.Our parts cover such applications as commercial,industrial, and automotives areas.

We are looking forward to setting up business relationship with you and hope to provide you with the best service and solution. Let us make a better world for our industry!



Contact us

Tel: +86-755-8981 8866 Fax: +86-755-8427 6832

Email & Skype: info@chipsmall.com Web: www.chipsmall.com

Address: A1208, Overseas Decoration Building, #122 Zhenhua RD., Futian, Shenzhen, China



1.2A Buck/Boost Charge Pump LED Driver

FEATURES

- Output Current up to 1.2A
- Up to 94% Efficiency in Torch Mode
- Adjustable FLASH Mode Current
- Minimum External Components: No Inductors
- Automatic Buck/Boost Mode Switchover
- Wide V_{IN} Range: 2.7V to 5.5V
- High Frequency Operation: 2.4 MHz
- 50mV Reference for low Loss Sensing
- $I_Q < 2\mu A$ in Shutdown
- PWM Dimming Control
- Automatic Soft Start Limits Inrush Current
- Overvoltage Protection on Output
- Overcurrent/temperature Protection
- Low Ripple and EMI
- Ultra-low Dropout Voltage in Buck Mode
- 2.6 Second Timeout in Flash Mode
- Space Saving RoHS Compliant, Lead Free Package: 10-pin 3mm x 3mm DFN

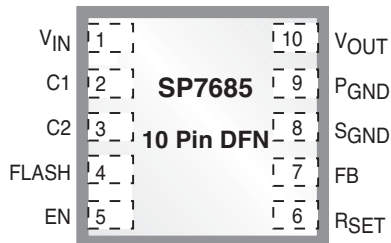

APPLICATIONS

- White LED Torch/Flash for Cell Phones, DSCs, and Camcorders
- White LED Backlighting
- Generic Lighting/Flash/Strobe Applications
- General Purpose High Current Boost

DESCRIPTION

The SP7685 is a current-regulated charge pump ideal for powering high brightness LEDs for camera flash applications. The charge pump can be set to regulate two current levels for FLASH and TORCH modes. The SP7685 automatically switches modes between step-up and step-down ensuring that LED current does not depend on the forward voltage. A low current sense reference voltage (50mV) allows the use of small 0603 current sensing resistors. The SP7685 is offered in 10-pin DFN package.

TYPICAL APPLICATION CIRCUIT

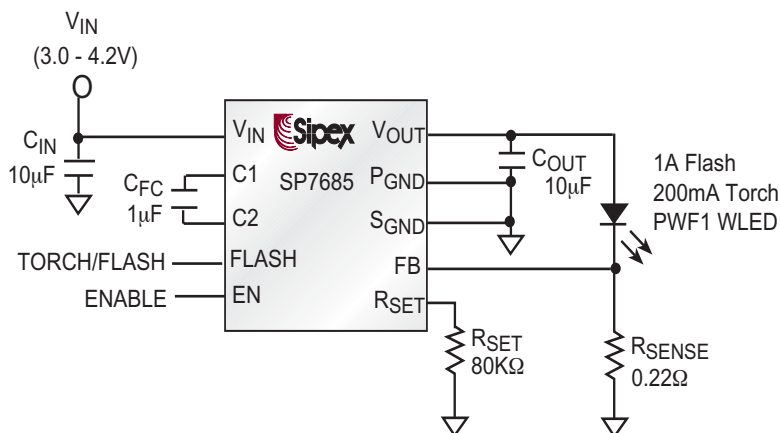

ABSOLUTE MAXIMUM RATINGS

V_{IN}, V_{OUT}	-0.3V to 6V
Output Current Pulse (Flash)	2A
Output Current Continuous (Torch)	0.4A
Storage Temperature	-65°C to +150°C
Operating Temperature	-40°C to +85°C
V_{EN}	0.0V to 7V
3x3 10 DFN	$\Theta_{JA} = 40.5^{\circ}\text{C/W}$
ESD Rating	2kV HBM

These are stress ratings only and functional operation of the device at these ratings or any other above those indicated in the operation sections of the specifications below is not implied. Exposure to absolute maximum rating conditions for extended periods of time may affect reliability.

ELECTRICAL CHARACTERISTICS

$T_A = -40^{\circ}\text{C}$ to $+85^{\circ}\text{C}$, $V_{IN} = 3.6\text{V}$, $C_{IN} = 10\mu\text{F}$, $C_{FC} = 1.0\mu\text{F}$, $C_{OUT} = 10\mu\text{F}$. $V_{SHDN} = V_{IN}$, typical values at 25°C . The ♦ denotes the specifications which apply over the full operating temperature range unless otherwise noted.

PARAMETER	MIN.	TYP.	MAX.	UNITS		CONDITIONS
Operating Input Voltage	2.7		5.5	V	♦	
Quiescent Current		0.5	3	mA	♦	$V_{IN} = 2.7 - 5.5\text{V}$ FLASH = GND, 1X Mode, $I_{LOAD} = 100\mu\text{A}$
		2				FLASH = High, 2x mode
Shutdown Current			2	μA		$V_{IN} = 5.5\text{V}$, $V_{EN} = 0.0\text{V}$
Oscillator Frequency		2.4		MHz		
Charge Pump Equivalent Resistance (x2 mode)		4		Ω		$V_{FB} = 0.0\text{V}$, $V_{IN} = 3.6\text{V}$
Charge Pump Equivalent Resistance (x1 mode)		0.4	0.7	Ω		$V_{IN} = 3.6\text{V}$
FB Reference Voltage	45	50	55	mV	♦	FLASH = GND
	138	150	162	mV	♦	FLASH = High, $R_{SET} = 53.6\text{k}\Omega$
FB Reference Voltage Range	100		400	mV	♦	FLASH = High. Guaranteed by design.
FB Pin Current			0.5	μA		$V_{FB} = 0.3\text{V}$
EN, FLASH Logic Low			0.4	V	♦	
EN, FLASH Logic High	1.3			V	♦	
EN, FLASH Pin Current			0.5	μA	♦	
V_{OUT} Turn-on Time		170	500	μs	♦	$V_{IN} = 3.6\text{V}$, FB within 90% of regulation
Thermal Shutdown Temperature		145		$^{\circ}\text{C}$		
Maximum Flash ON time	1.6	2.6	3.6	s	♦	FLASH = High

PIN NUMBER	PIN NAME	DESCRIPTION
1	V _{IN}	Input Voltage for the charge pump. Decouple with 4.7 μ F ceramic capacitor close to the pins of the IC.
2	C1	Positive input for the external flying capacitor. Connect a ceramic 1 μ F capacitor close to the pins of the IC.
3	C2	Negative input for the external flying capacitor. Connect a ceramic 1 μ F capacitor close to the pins of the IC.
4	FLASH	Logic input to toggle operation between FLASH and TORCH mode. In TORCH mode FB is regulated to the internal 50mV reference. In FLASH mode FB reference voltage can be adjusted by changing the resistor from R _{SET} pin to ground. Choose the external current sense resistor (R _{SENSE}) based on desired current in TORCH mode. This pin does not have an internal pull-up/pull-down; do not leave this pin floating.
5	EN	Shutdown control input. Connect to V _{IN} for normal operation, connect to ground for shutdown. This pin does not have an internal pull-up/pull-down; do not leave this pin floating.
6	R _{SET}	Connect a resistor from this pin to ground. When in FLASH mode (FLASH = High) this resistor sets the current regulation point according to the following: V _{FB} = R _{SET} *14 μ A/5 (Flash Mode)
7	FB	Feedback input for the current control loop. Connect directly to the current sense resistor.
8	S _{GND}	Internal ground pin. Control circuitry returns current to this pin.
9	P _{GND}	Power ground pin. Flying capacitor current returns through this pin.
10	V _{OUT}	Charge Pump Output Voltage. Decouple with an external capacitor. At least 1 μ F is recommended. Higher capacitor values reduce output ripple

In the Torch mode, (Flash = GND) the Flash pin is set to logic low and the SP7685 FB pin regulates to 50mV output:

$$V_{FB} = 50\text{mV (Torch Mode)}$$

When in Flash mode, (Flash = V_{IN}), the FB regulation voltage is set by the resistor R_{SET} connected between the R_{SET} pin and S_{GND} and the equation:

$$V_{FB} = R_{SET} * 14\mu\text{A} / 5 \text{ (Flash Mode)}$$

Where $14\mu\text{A}$ is an internal regulated current and 5 is an internal factor used to scale the V_{SET} voltage to the V_{FB} voltage. Typical values of R_{SET} are $140\text{K}\Omega$ to $35\text{K}\Omega$ for a range of $V_{FB} = 400\text{mV}$ to 100mV in Flash mode.

The output current is then set in either Flash or Torch mode by the equation:

$$I_{OUT} = V_{FB} / R_{SENSE}$$

FLASH TIMEOUT PROTECTION

Due to the high currents typically available in Flash mode, it is necessary to protect the white LED from damage if left on too long. The SP7685 has a timeout in Flash mode of approximately 2.6 seconds after which it will shut down operation. Operation will not begin again in Flash mode until the Enable pin or Flash pin have been set Low and then High again.

OVERTEMPERATURE PROTECTION

When the temperature of the SP7685 rises above 145°C , the overtemperature protec-

tion circuitry turns off the output switches to prevent damage to the device. If the temperature drops back down below 135°C , the part automatically recovers and executes a soft start cycle.

OVERVOLTAGE PROTECTION

The SP7685 has over voltage protection. If the output voltage rises above the 5.5V threshold, the over voltage protection shuts off all of the output switches to prevent the output voltage from rising further. When the output decreases below 5.5V , the device resumes normal operation.

OVERCURRENT PROTECTION

The over current protection circuitry monitors the average current out of the V_{OUT} pin. If the average output current exceeds approximately 1.6 Amps, then the overcurrent protection circuitry shuts off the output switches to protect the chip.

BRIGHTNESS CONTROL USING PWM

Dimming control can be achieved by applying a PWM control signal to the EN pin. The brightness of the white LEDs is controlled by increasing and decreasing the duty cycle of the PWM signal. While the operating frequency range of the PWM control is from 60Hz to 700Hz , the recommended maximum brightness frequency range of the PWM signal is from 60Hz to 200Hz . A repetition rate of at least 60Hz is required to prevent flicker.

V_{IN} =3.6V, Typical Application Circuit, T_A = 25°C unless otherwise noted.

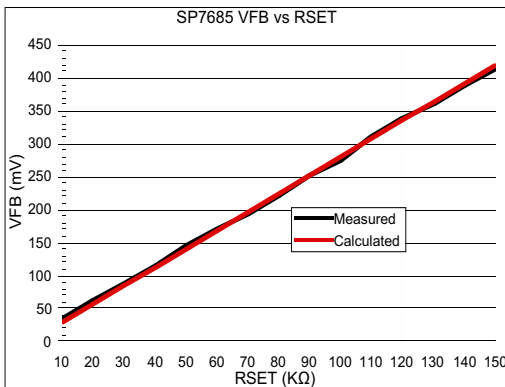
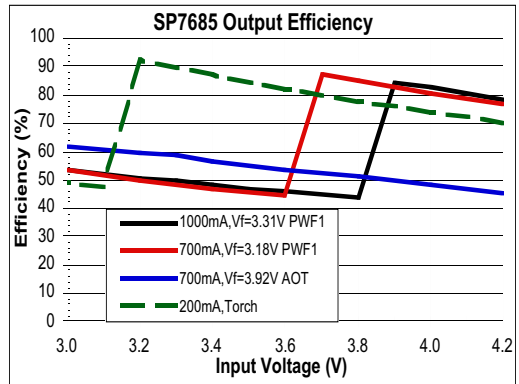
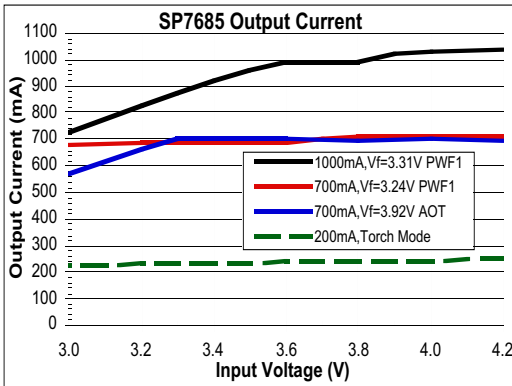
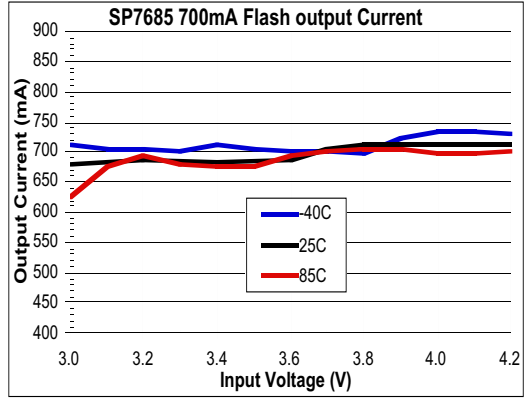
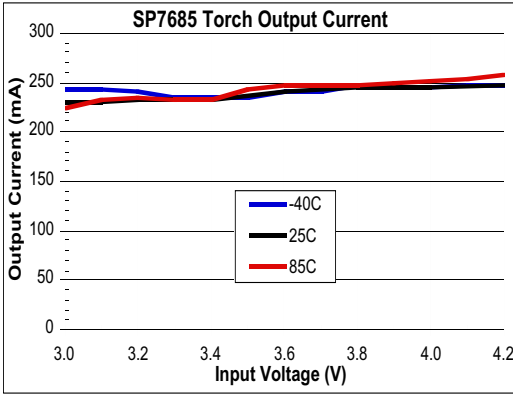

APPLICATION INFORMATION

$V_{IN}=3.6V$, Typical Application Circuit, $T_A = 25^{\circ}C$ unless otherwise noted.

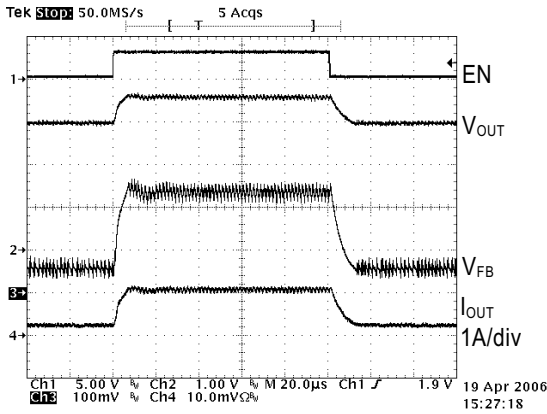

Torch in 1X to Flash in 1X Mode, $V_{IN}=4.2V$

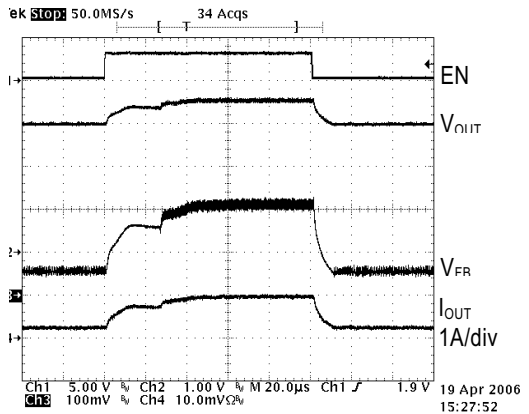

Torch in 1X to Flash in 2X Mode, $V_{IN}=3.6V$

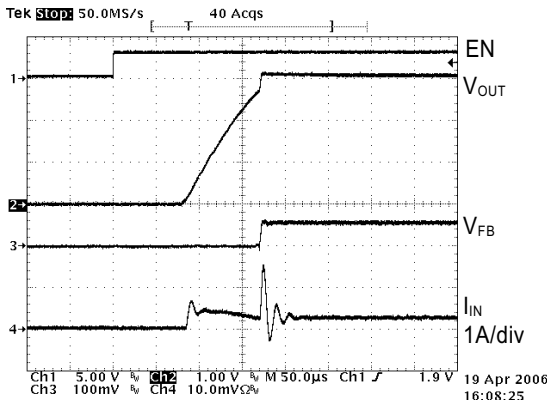

Start Up 200mA Torch
 $V_{IN}=3.6V$, $V_{OUT}=3.1V$

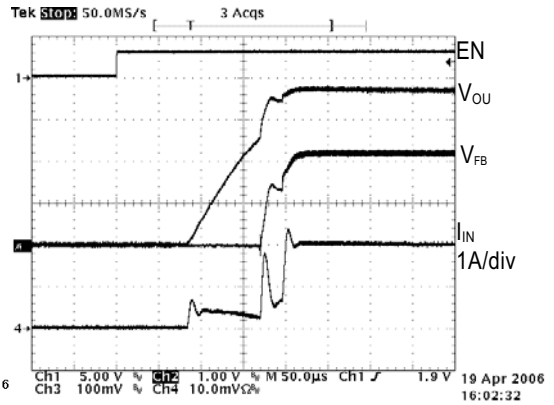

Start Up 1000mA Flash
 $V_{IN}=3.6V$, $V_{OUT}=3.8V$

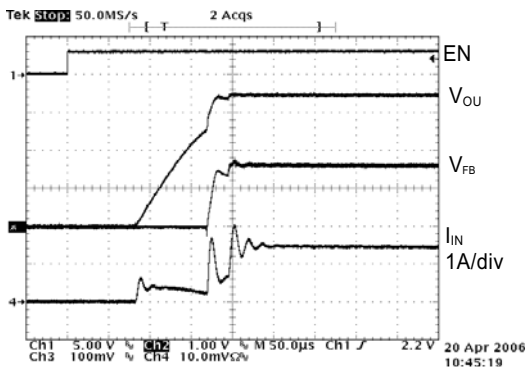

Start Up 700mA Flash
 $V_{IN}=3.6V$, $V_{OUT}=3.6V$

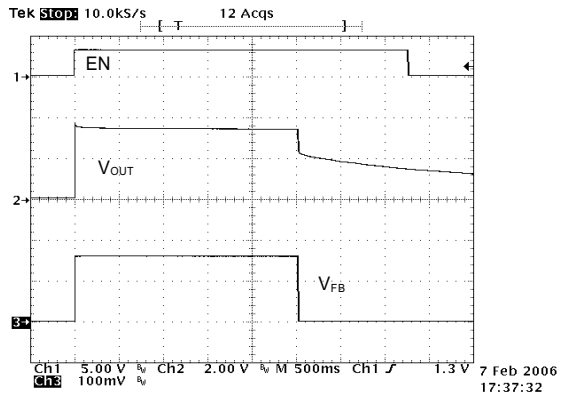

Flash Mode TimeOut Circuit at 2.6sec.
 $V_{IN}=4.2V$, $I_{OUT}=1A$

APPLICATION INFORMATION

$V_{IN}=3.6V$, Typical Application Circuit, $T_A=25^{\circ}C$ unless otherwise noted.

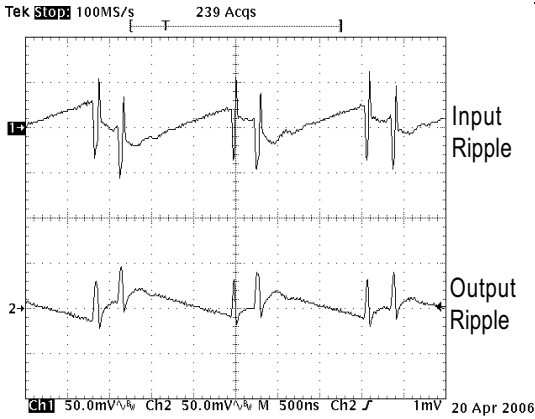

Ripple 1X Torch 200mA, $V_{IN}=4.2V$

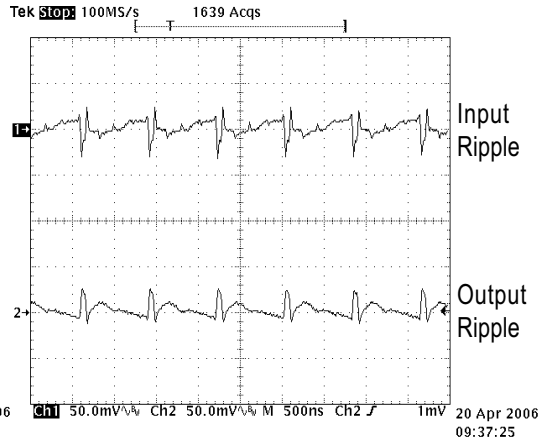

Ripple 2X Torch 200mA, $V_{IN}=3.0V$

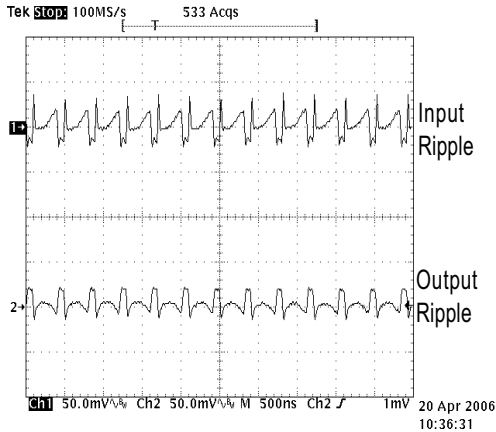

Ripple 1X Flash 700mA, $V_{IN}=4.2V$

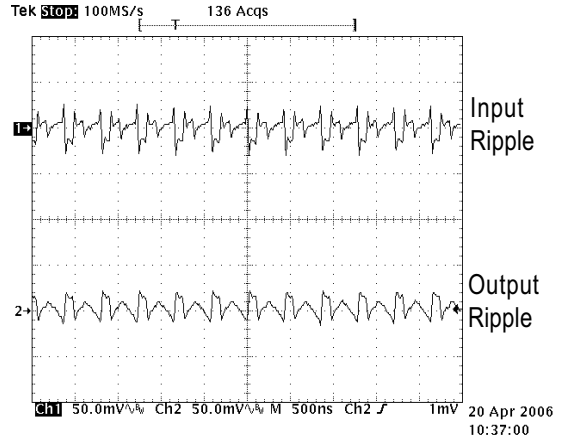

Ripple 2X Flash 700mA, $V_{IN}=3.6V$

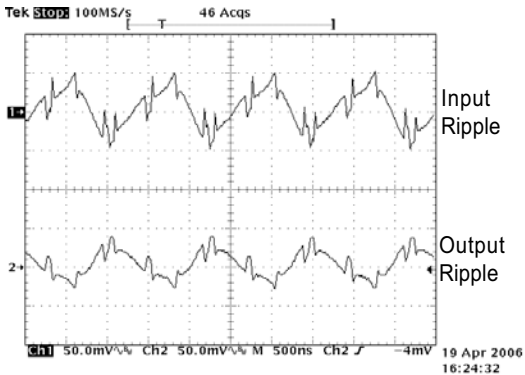

Ripple 1X Flash 1000mA, $V_{IN}=4.2V$

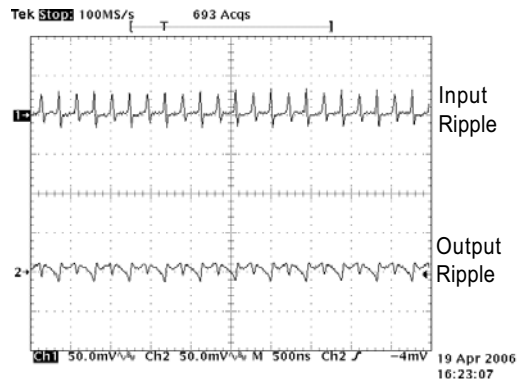

Ripple 2X Flash 1000mA, $V_{IN}=3.6V$

The SP7685 charge pump circuit requires three capacitors: 10µF input, 10µF output and 1µF fly capacitor are typically recommended. For the input capacitor, a value of 10µF will help reduce input voltage ripple for applications sensitive to ripple on the battery voltage. All the capacitors should be surface mount ceramic for low lead inductance necessary at the 2.4MHz switching frequency of the SP7685 and to obtain low ESR, which improves bypassing on the input and output and improves output voltage drive by reducing output resistance. Ceramic capacitors with X5R or X7R temperature grade are recommended for most applications. A selection of recommended capacitors is included in Table 1 below.

Manufacturer's Website	Part Number	Capacitance/ Voltage	Capacitor Size/ Type/Thickness	ESR @100kHz
TDK: www.tdk.com	C1005X5R0J105M	1uF/6.3V	0402/X5R/0.5mm	0.03
TDK: www.tdk.com	C1608X5R0J475K	4.7uF/6.3V	0603/X5R/0.9mm	0.02
TDK: www.tdk.com	C2012X5R0J106M	10uF/6.3V	0805/X5R/1.35mm	0.02
Murata: www.murata.com	GRM155R60J105KE19B	1uF/6.3V	0402/X5R/0.55mm	0.03
Murata: www.murata.com	GRM188R60J475KE19	4.7uF/6.3V	0603/X5R/0.9mm	0.02
Murata: www.murata.com	GRM21BR60J106KE19L	10uF/6.3V	0805/X5R/1.35mm	0.02

Table 1: Recommended Capacitors

The input and output capacitors should be located as close to the V_{IN} and V_{OUT} pins as possible to obtain best bypassing, and the returns should be connected directly to the P_{GND} pin or to the thermal pad ground located under the SP7685. The fly capacitor should be located as close to the C1 and C2 pins as possible. See typical circuit layout at the end of this section for details on the recommended layout.

To obtain low output ripple, a value of 10µF is recommended for C_{OUT} . For output currents of 500mA to 1.2A, the recommended C_{FC} fly capacitor value of 1µF should be used. Output currents in Flash of 100mA to 400mA can use a 0.47µF C_{FC} but a minimum 4.7µF C_{OUT} is still needed.

RESISTOR SELECTION

The sense resistor R_{SENSE} is determined by the value needed in the Torch mode for the desired output current by the equation:

$$R_{SENSE} = V_{FB} / I_{OUT} \text{ where } V_{FB} = 50mV \text{ (Torch Mode)}$$

Once the R_{SENSE} resistor has been selected for Torch mode, the V_{FB} voltage can be selected for Flash mode using the following equation:

$$V_{FB} = I_{OUT} * R_{SENSE} \text{ (Flash Mode) where } I_{OUT} \text{ is for Flash Mode.}$$

Next, the R_{SET} resistor can be selected for Flash mode using the following equation:

$$R_{SET} = \left(\frac{V_{FB}}{14\mu A} \right) * 5 \Omega \text{ (Flash Mode)}$$

For an example of 200mA Torch mode and 700mA Flash mode, the values $R_{SENSE} = 0.22\Omega$, $V_{FB} = 155mV$ (Flash Mode), and $R_{SET} = 56K\Omega$ are calculated. The power obtained in the Flash mode would be:

$$P_{FLASH} = V_{FB} * I_{OUT} = 155mV * 700mA = 109mW.$$

The typical 0603 surface mount resistor is rated 1/10 Watt continuous power and 1/5

Watt pulsed power, more than enough for this application. For other applications, the P_{FLASH} power can be calculated and resistor size selected. The R_{SENSE} resistor is recom-

mended to be size 0603 for most applications. The range of typical resistor values and sizes are shown here in Table 2.

Part Reference	Value	Tolerance	Size	Manufacturers
RSET	33k Ω	5%	0402	any
RSET	39k Ω	5%	0402	any
RSET	43k Ω	5%	0402	any
RSET	47k Ω	5%	0402	any
RSET	56k Ω	5%	0402	any
RSET	62k Ω	5%	0402	any
RSET	68k Ω	5%	0402	any
RSET	82k Ω	5%	0402	any
RSET	100k Ω	5%	0402	any
RSET	110k Ω	5%	0402	any
RSET	120k Ω	5%	0402	any
RSET	150k Ω	5%	0402	any
RSENSE	0.22 Ω	5%	0603	Panasonic or Vishay
RSENSE	0.27 Ω	5%	0603	Panasonic or Vishay
RSENSE	0.33 Ω	5%	0603	Panasonic or Vishay
RSENSE	0.39 Ω	5%	0603	Panasonic or Vishay
RSENSE	0.47 Ω	5%	0603	Panasonic or Vishay
RSENSE	0.56 Ω	105%	0604	Panasonic or Vishay
RSENSE	0.68 Ω	205%	0605	Panasonic or Vishay

Table 2: Resistor values and sizes

EVALUATION BOARD CIRCUIT LAYOUT

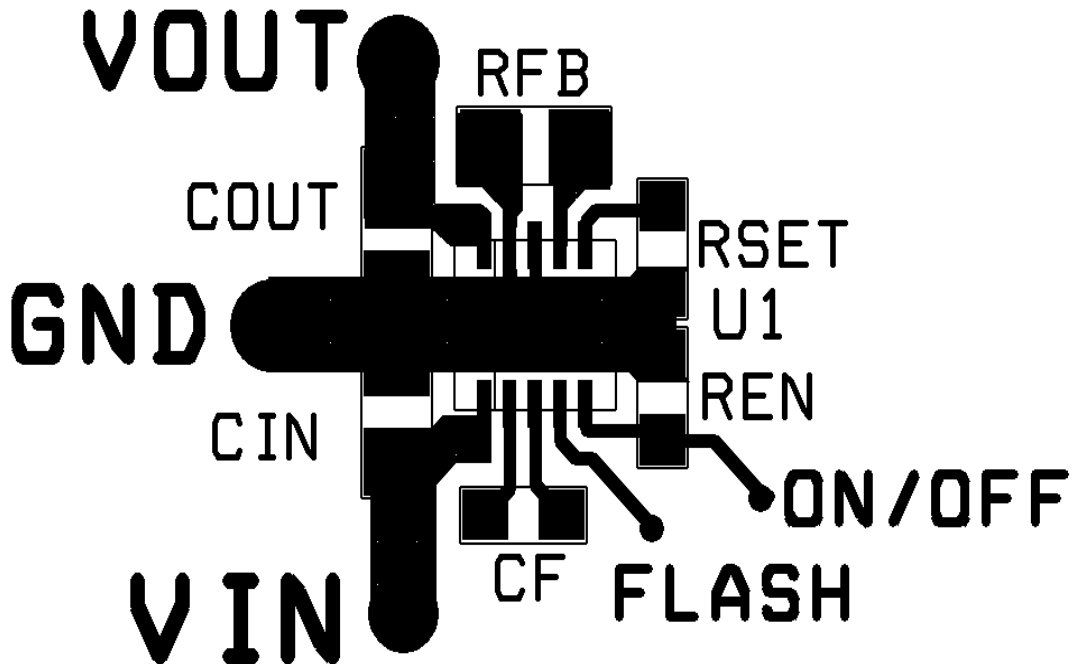

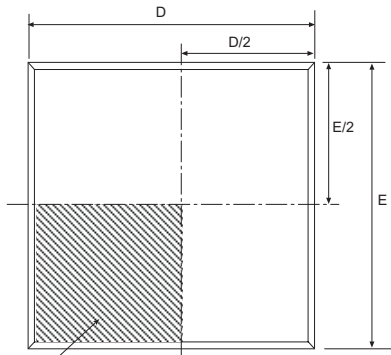

Pin1 Designator
to be within this
INDEX AREA
(D/2 x E/2)

TOP VIEW

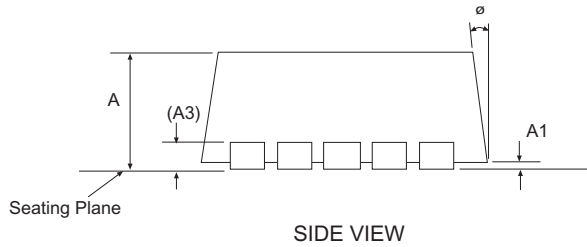

SIDE VIEW

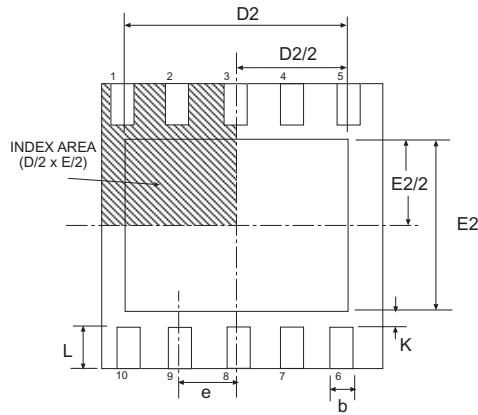

BOTTOM VIEW

3x3 10 Pin DFN		JEDEC MO-229		VARIATION VEED-5		
SYMBOL	Dimensions in Millimeters: Controlling Dimension			Dimensions in Inches Conversion Factor: 1 Inch = 25.40 mm		
	MIN	NOM	MAX	MIN	NOM	MAX
A	0.80	0.90	1.00	0.032	0.036	0.039
A1	0.00	0.02	0.05	0.000	0.001	0.002
A3	0.20 REF			0.008 REF		
K	0.20	-	-	0.008	-	-
ø	0°	-	14°	0°	-	14°
b	0.18	0.25	0.30	0.008	0.010	0.012
D	3.00 BSC			0.119 BSC		
D2	2.20	-	2.70	0.087	-	0.106
E	3.00 BSC			0.119 BSC		
E2	1.40	-	1.75	0.056	-	0.069
e	0.50 BSC			0.020 BSC		
L	0.30	0.40	0.50	0.012	0.016	0.020
SIPEX Pkg Signoff Date/Rev:				JL Aug09-05 / RevA		

ORDERING INFORMATION

Part Number	Operating Temperature Range	Package Type
SP7685ER-L	-40°C to +85°C	(Lead Free) 10 Pin DFN
SP7685ER-L/TR	-40°C to +85°C	(Lead Free) 10 Pin DFN

/TR = Tape and Reel

Pack quantity is 3,000 for DFN.

**Sipex Corporation**

**Headquarters and
Sales Office**
233 South Hillview Drive
Milpitas, CA 95035
TEL: (408) 934-7500
FAX: (408) 935-7600

Sipex Corporation reserves the right to make changes to any products described herein. Sipex does not assume any liability arising out of the application or use of any product or circuit described herein; neither does it convey any license under its patent rights nor the rights of others.