



Chipsmall Limited consists of a professional team with an average of over 10 year of expertise in the distribution of electronic components. Based in Hongkong, we have already established firm and mutual-benefit business relationships with customers from,Europe,America and south Asia,supplying obsolete and hard-to-find components to meet their specific needs.

With the principle of “Quality Parts,Customers Priority,Honest Operation,and Considerate Service”,our business mainly focus on the distribution of electronic components. Line cards we deal with include Microchip,ALPS,ROHM,Xilinx,Pulse,ON,Everlight and Freescale. Main products comprise IC,Modules,Potentiometer,IC Socket,Relay,Connector.Our parts cover such applications as commercial,industrial, and automotives areas.

We are looking forward to setting up business relationship with you and hope to provide you with the best service and solution. Let us make a better world for our industry!



Contact us

Tel: +86-755-8981 8866 Fax: +86-755-8427 6832

Email & Skype: info@chipsmall.com Web: www.chipsmall.com

Address: A1208, Overseas Decoration Building, #122 Zhenhua RD., Futian, Shenzhen, China



Very low power network processor module for Bluetooth® Low Energy v4.1

Datasheet - production data



Features

- Bluetooth v4.1 compliant
 - Supports master and slave modes
 - Multiple roles supported simultaneously
- Embedded Bluetooth low energy protocol stack
 - GAP, GATT, SM, L2CAP, LL, RFPHY
- Bluetooth low energy profiles provided separately
- Bluetooth radio performance:
 - Embedded ST BlueNRG-MS
 - Tx power: + 4 dBm
 - Rx sensitivity: - 88 dBm
 - Provides up to 92 dB link budget with excellent link reliability
- Host interface
 - SPI, IRQ, and RESET
 - On-field stack upgrading available via SPI
- AES security co-processor
- Certifications:
 - CE qualified
 - FCC, IC modular approval certified
 - BT SIG qualified
- On-board chip antenna

- Operating supply voltage: from 1.7 to 3.6 V
- Operating temperature range: -40 °C to 85 °C

Applications

- Watches
- Fitness, wellness and sports
- Consumer medical
- Security/proximity–
- Remote control
- Home and industrial automation
- Assisted living
- Mobile phone peripherals
- PC peripherals

Description

The SPBTLE-RF0 is an easy to use Bluetooth® Low Energy network processor module, compliant with Bluetooth v4.1. The SPBTLE-RF0 module supports multiple roles simultaneously, and can act at the same time as Bluetooth Low Energy master and slave device.

The entire Bluetooth Low Energy stack and protocols are embedded into SPBTLE-RF0 module. The external host application processor, where the application resides, is connected to the SPBTLE-RF0 module through a standard SPI interface.

The SPBTLE-RF0 module provides a complete RF platform in a tiny form factor. Radio, antenna and high frequency oscillators are integrated to offer a certified solution to optimize the time to market of the final applications.

The SPBTLE-RF0 can be powered directly with a pair of AAA batteries or any power source from 1.7 to 3.6 V.

Contents

1 General description..... 5

2 Block schematic 6

3 Software development 7

4 Software architecture 8

5 Hardware specifications 9

 5.1 Current consumption 9

 5.2 Pin assignment..... 14

 5.3 Mechanical dimensions 15

6 Hardware design 17

 6.1 Reflow soldering..... 17

7 Regulatory compliance 19

 7.1 FCC certification..... 19

 7.1.1 Labeling instructions 19

 7.1.2 Product manual instructions 20

 7.2 IC certification 21

 7.2.1 Labelling instructions 21

 7.2.2 Product manual instructions 23

 7.3 CE certification for SPBTLE-RF0 module 24

 7.4 Bluetooth certification 24

8 Ordering information..... 25

9 ECOPACK®..... 26

10 Traceability 27

11 Revision history 28

List of tables

Table 1: Absolute maximum ratings	9
Table 2: Recommended operating conditions	9
Table 3: Current consumption	9
Table 4: Pin description	14
Table 5: Soldering	17
Table 6: Ordering information	25
Table 7: Traceability information	27
Table 8: Document revision history	28

List of figures

Figure 1: HW block diagram	6
Figure 2: IFR configuration for SPBTLE-RF0	7
Figure 3: SPBTLE-RF0 application block diagram	8
Figure 4: Configuration of the “BlueNRG current consumption estimation tool”	10
Figure 5: Peripheral in advertising (Adv Int = 20 ms)	10
Figure 6: Peripheral in advertising (Adv Int = 40 ms)	11
Figure 7: Peripheral in connection (Conn Int = 80 ms)	11
Figure 8: Peripheral in connection (Conn Int = 40 ms)	12
Figure 9: Central in scan mode (Scan Int = 1250 ms, Scan Window = 1250 ms)	12
Figure 10: Central in scan mode (Scan Int = 1250 ms, Scan Window = 625 ms)	13
Figure 11: Central in connection (Conn Int = 40 ms)	13
Figure 12: Pin assignment	14
Figure 13: SPBTLE-RF0 module mechanical dimensions	15
Figure 14: Recommend land pattern top view	16
Figure 15: Soldering profiles	18
Figure 16: CE certified	24

1 General description

The SPBTLE-RF0 is a Bluetooth Low Energy network processor module compliant with Bluetooth® v4.1.

The SPBTLE-RF0 module integrates the BlueNRG-MS BT radio controller with an on-board power-optimized Bluetooth stack.

It supports:

- Both master and slave roles
- GAP: central, peripheral, observer or broadcaster roles
- ATT/GATT: client and server
- SM: privacy, authentication and authorization
- L2CAP

The BlueNRG-MS radio embeds nonvolatile Flash memory which allows on-field stack upgrading.

In accordance with Bluetooth specification v4.1, the SPBTLE-RF0 module supports:

- Multiple simultaneous roles
- Simultaneous advertising and scanning
- Acting as slave for up to two masters simultaneously
- Privacy V1.1
- Low duty cycle directed advertising
- Connection parameter request procedure
- LE Ping
- 32 bits UUIDs
- L2CAP connection oriented channels

Both standard and proprietary Bluetooth low energy profiles, as well as a wide set of examples are available for the SPBTLE-RF0 from the ST website.

The external host application processor where the application resides is interfaced with the SPBTLE-RF0 module through an application controller interface protocol based on a standard SPI interface.

With the SPBTLE-RF0 module, developers can enable wireless connectivity in electronic devices without requiring any RF experience or expertise for integration into the final product. The SPBTLE-RF0 module provides a complete RF platform in a tiny form factor (13.5 x 11.5 x 2 mm) and, being a certified solution, optimizes the time to market of the final applications.

The SPBTLE-RF0 module allows applications to meet the tight peak current requirements when using standard coin cell batteries. SPBTLE-RF0 can be powered directly from a standard 3 V coin cell battery, a pair of AAA batteries or any power source from 1.7 to 3.6 V.

ST may update the FW provided with the modules at any time. ST recommends that users regularly check for documentation and the current FW version available at www.st.com/bluemodules.

2 Block schematic

Figure 1: HW block diagram

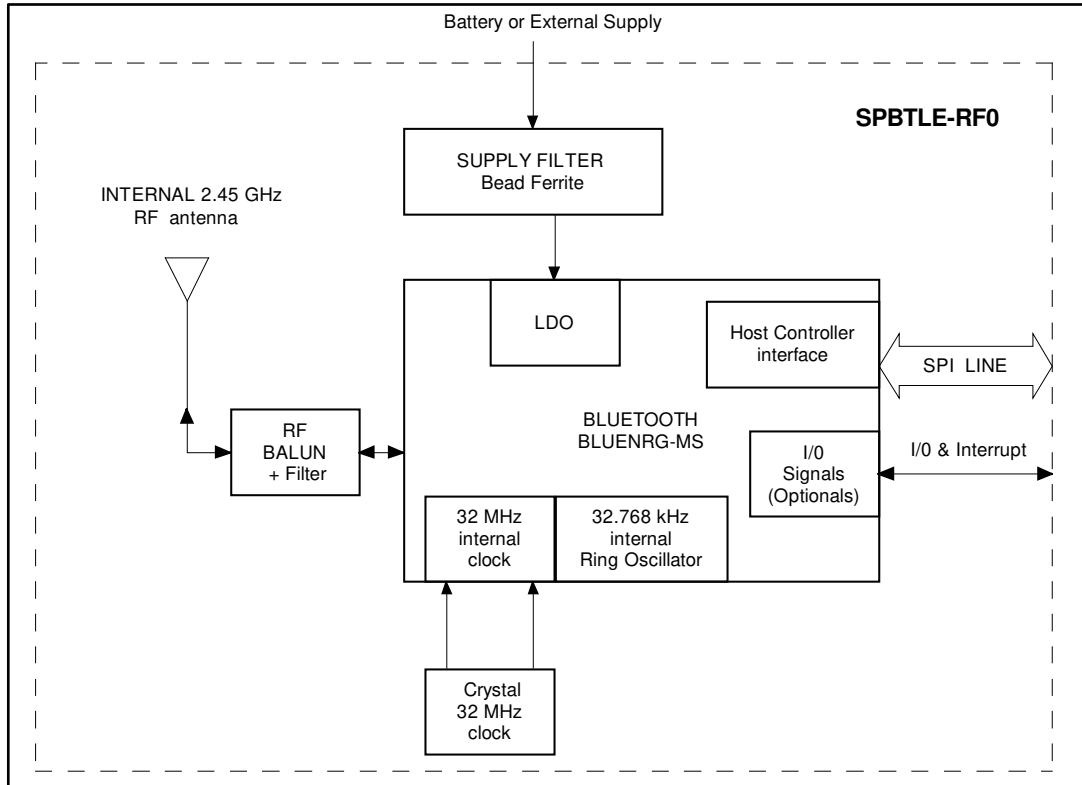

3 Software development

The SPBTLE-RF0 module embeds the BlueNRG-MS application processor. Refer to the BlueNRG-MS web page (<http://www.st.com/en/wireless-connectivity/bluenrg-ms.html>) to access:

- BlueNRG-MS datasheet
- development kit
- application notes
- user manuals
- tools and software
- design note and tips

For module firmware updates (BlueNRG-MS Bluetooth Stack), take into account the SPBTLE-RF0-specific configuration (see the block diagram) to select the proper binary file from the BlueNRG-MS Development Kit (STSW-BLUENRG-DK).

In particular the SPBTLE-RF0 module is configured with:

- 32 MHz crystal oscillator
- 32 KHz Ring Oscillator
- Internal LDO (SMPS Off)

From the prebuilt image files provided for the BlueNRG-MS Development Kit, only the files with “32MHz”, “RO32K”, and “SMPS_OFF” in the file name are suitable for the SPBTLE-RF0.

For example only the `ifr_3v1_003_mode02-32MHz-RO32K_SMPS_OFF.dat` file is suitable for the SPBTLE-RF0.

When used with the BlueNRG-GUI, the IFR configuration settings should reflect those pictured below.

Figure 2: IFR configuration for SPBTLE-RF0

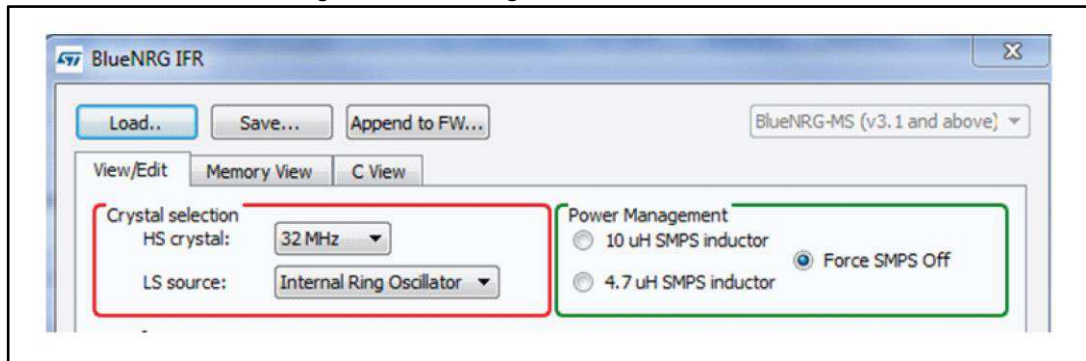

4 Software architecture

The SPBTLE-RF0 module has been designed to work with an external Host processor connected via SPI.

Figure 3: SPBTLE-RF0 application block diagram

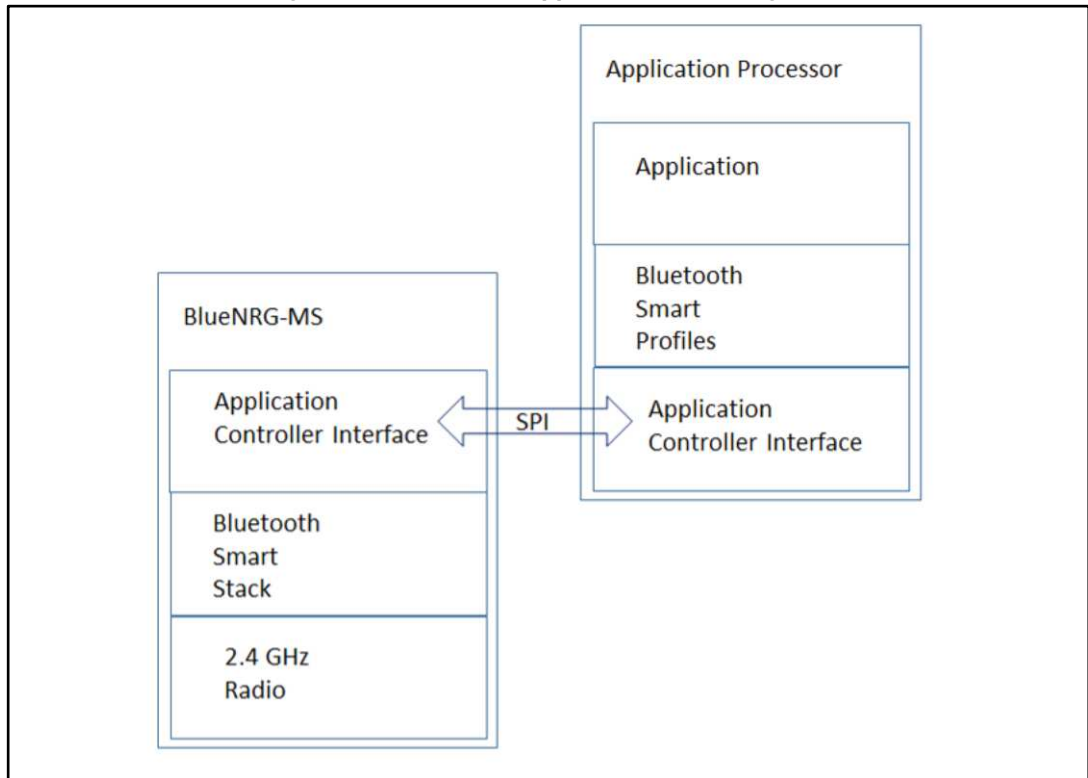

5 Hardware specifications

General conditions ($V_{IN} = 3.3\text{ V}$ and 25 °C)

Table 1: Absolute maximum ratings

Rating	Min.	Typ.	Max.	Unit
Storage temperature range	- 40		+ 85	°C
Supply voltage, V_{IN}	- 0.3		+ 3.9	V
I/O pin Voltage (V_{IO} five-volt tolerant pin)	- 0.3		+ 3.9	V
RF saturation input power		8		dBm

Table 2: Recommended operating conditions

Rating	Min.	Typ.	Max.	Unit
Operating temperature range	- 40		+ 85	°C
Supply voltage, V_{IN}	1.7	1.8	3.6	V
Signals & I/O pin voltage (according supply voltage)	1.7		3.6	V
RF Frequency	2402		2480	MHz

5.1 Current consumption

Measurement conditions: $V_{IN} = 3.0\text{ V}$, TX output power = +4 dBm, temperature = 25 °C , FW version = 7.1e

Table 3: Current consumption

Symbol	Parameter	Test conditions	Typ.	Peak	Unit
I_{DD}	Supply current	Shutdown / STANDBY	1.98	1.98	μA
		Peripheral in Advertising (Adv Int = 20 ms)	1.36	20.5	mA
		Peripheral in Advertising (Adv Int = 40 ms)	0.68	20.5	mA
		Peripheral in Advertising (Adv Int = 80 ms)	0.34	20.5	mA
		Peripheral in connection (Conn Int = 40 ms)	0.20	20.5	mA
		Central in Scan Mode (Scan Int = 1250 ms, Scan Window = 1250 ms)	14.49	14.49	mA
		Central in Scan Mode (Scan Int = 1250 ms, Scan Window = 625 ms)	7.24	14.49	mA
		Central in connection (Conn Int = 40 ms)	0.186	20.5	mA

To increase the SPBTLE-RF0 module power efficiency, it is suggested to use 1.7 V power supply.

For each calculated value refer to the following screenshots:

Figure 4: Configuration of the “BlueNRG current consumption estimation tool”

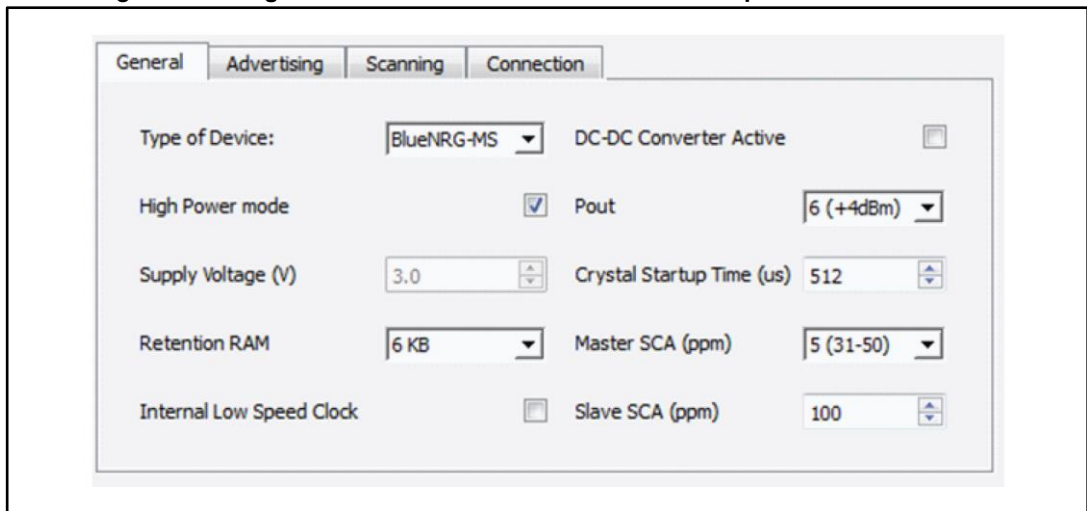

Figure 5: Peripheral in advertising (Adv Int = 20 ms)



Figure 6: Peripheral in advertising (Adv Int = 40 ms)

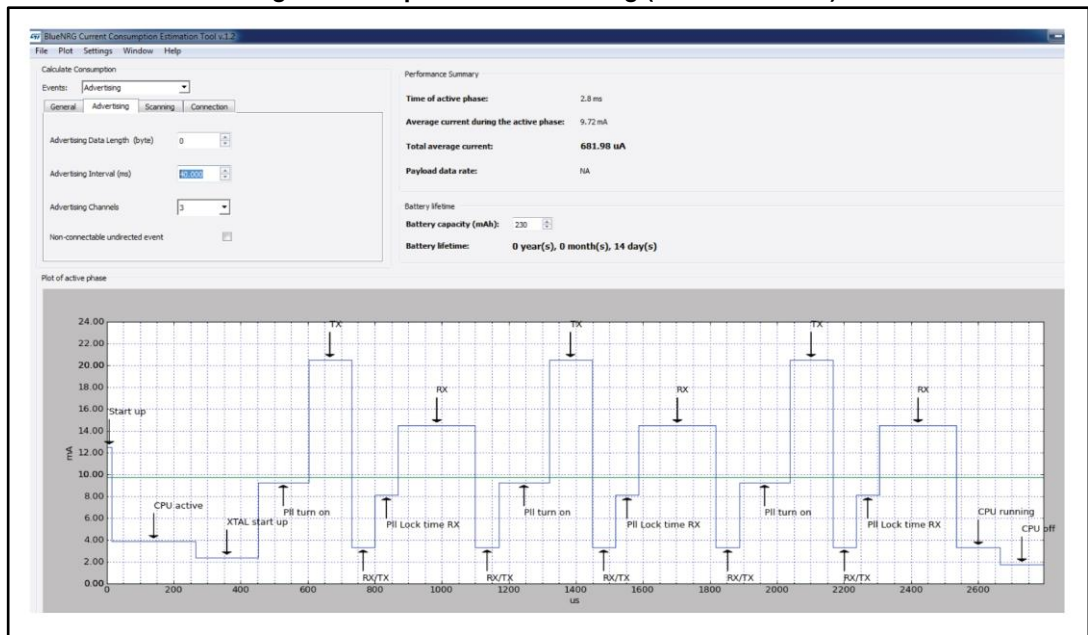

Figure 7: Peripheral in connection (Conn Int = 80 ms)

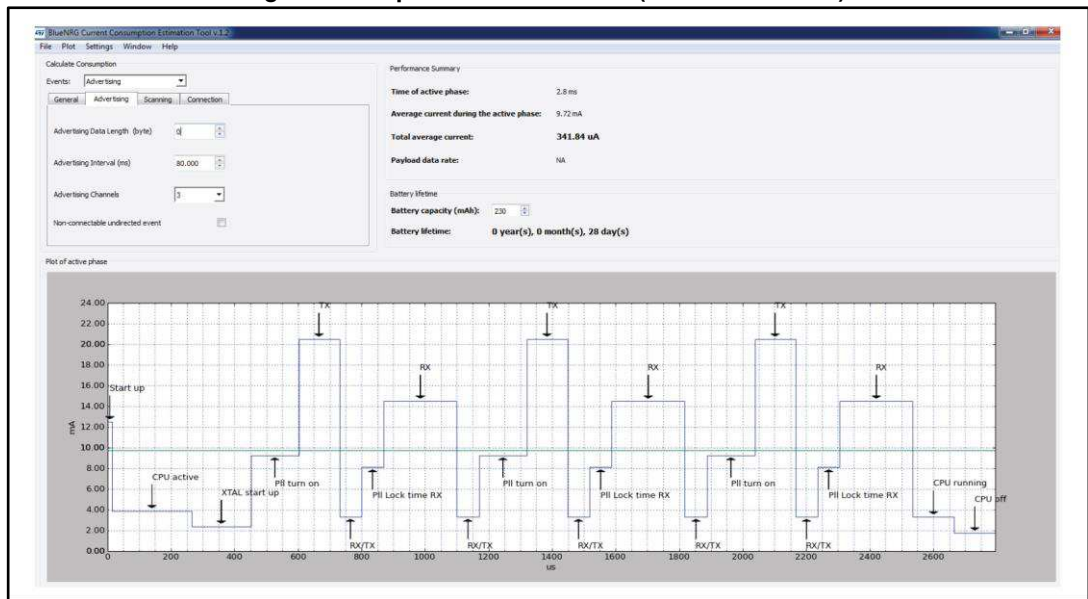

Figure 8: Peripheral in connection (Conn Int = 40 ms)

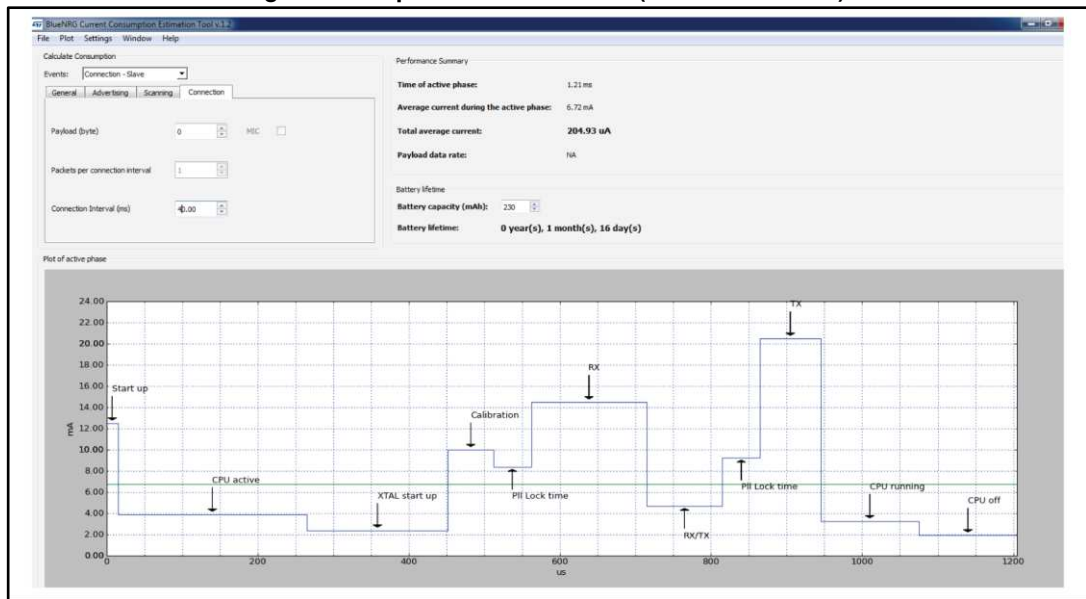

Figure 9: Central in scan mode (Scan Int = 1250 ms, Scan Window = 1250 ms)

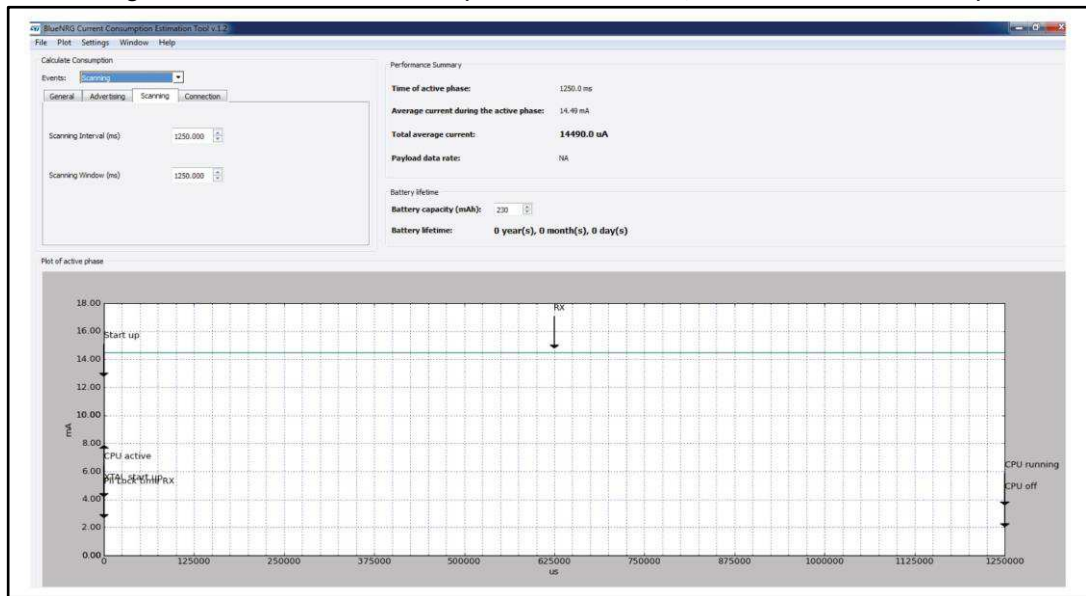

Figure 10: Central in scan mode (Scan Int = 1250 ms, Scan Window = 625 ms)

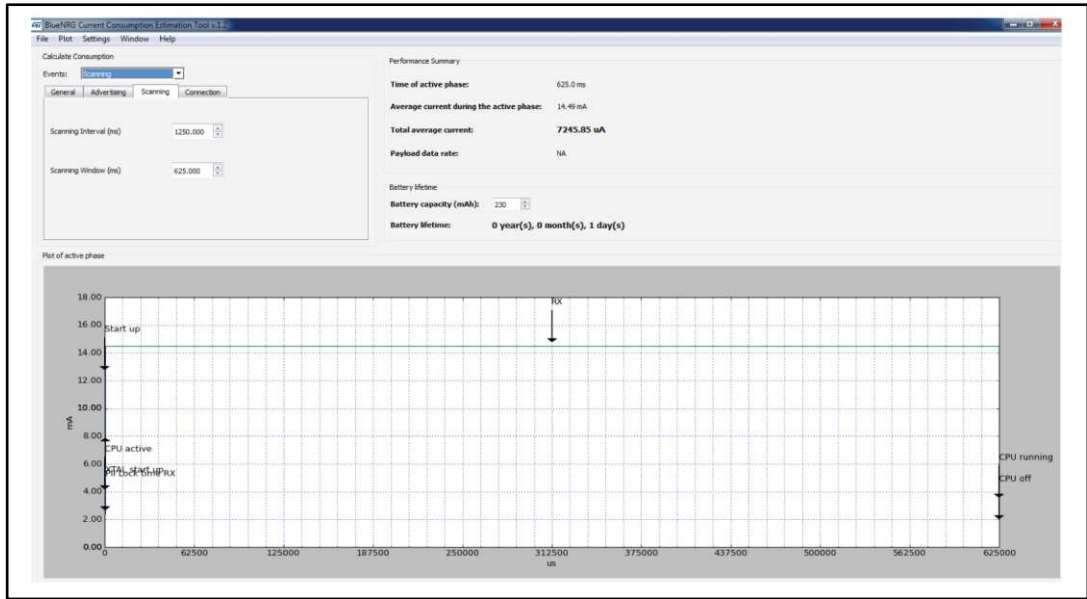
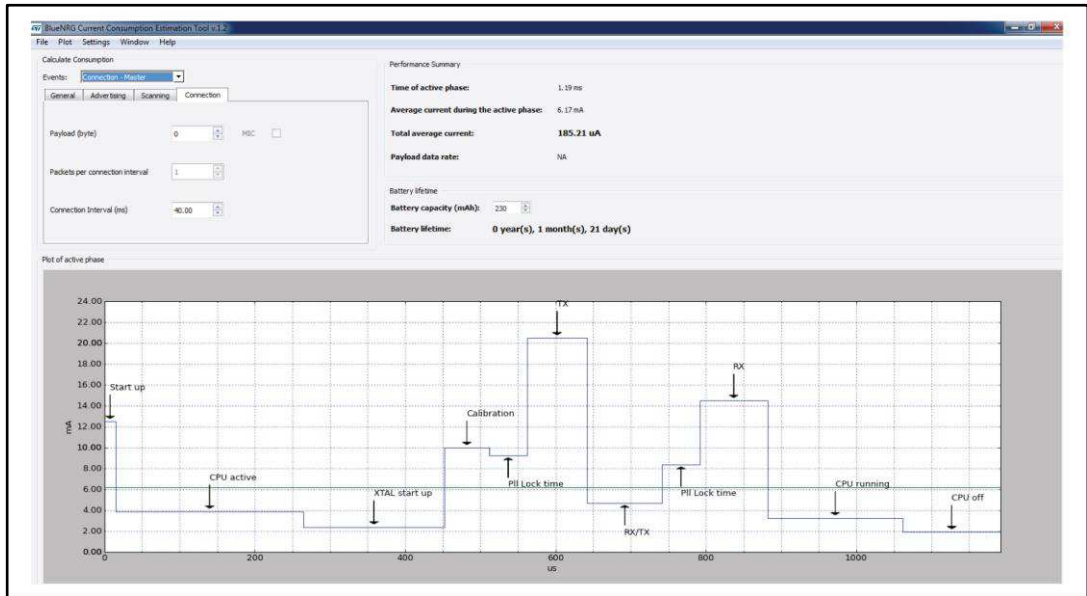

Figure 11: Central in connection (Conn Int = 40 ms)



5.2 Pin assignment

Figure 12: Pin assignment

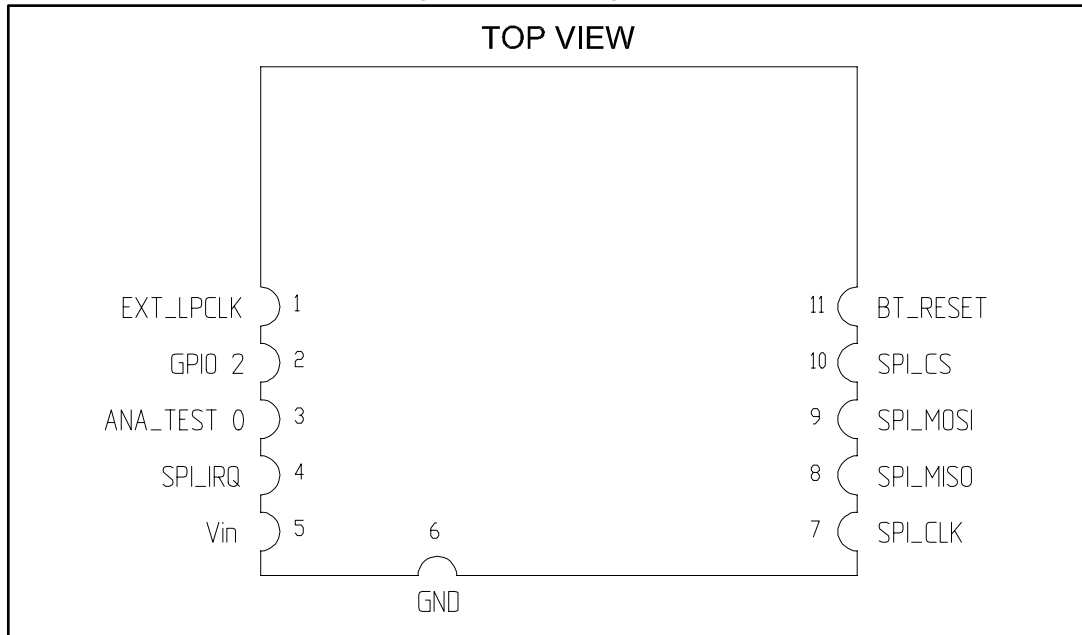

Table 4: Pin description

Name	Type	Pin n°	Description	V max. tolerant
SPI Interface				
SPI_IRQ	O	4	SPI IRQ (SLAVE has data for MASTER)	V _{in}
SPI_IRQSPI_CLK	I	7	SPI CLOCK (Max. 8 MHz)	V _{in}
SPI_MISO	O	8	SPI MISO (MASTER in / SLAVE out)	V _{in}
SPI_MOSI	I	9	SPI MOSI (MASTER out SLAVE in)	V _{in}
SPI_CS	I	10	SPI “Chip select” (SPI slave select)	V _{in}
Power and ground				
V _{in}		5	V _{in}	(1.7 V - 3.6 V max.)
GND		6	GND	
Reset				
BT_RESET	I	11	Reset input (active low < 0.35 V _{in})	(1.7 V - 3.6 V max.)
Not connected				
EXT_LPCLK	I	1	Not connected. Must be left floating.	
GPIO2	I/O	2	Not connected. Must be left floating.	
ANA TEST 0	I	3	Not connected. Must be left floating.	

5.3 Mechanical dimensions

Figure 13: SPBTLE-RF0 module mechanical dimensions

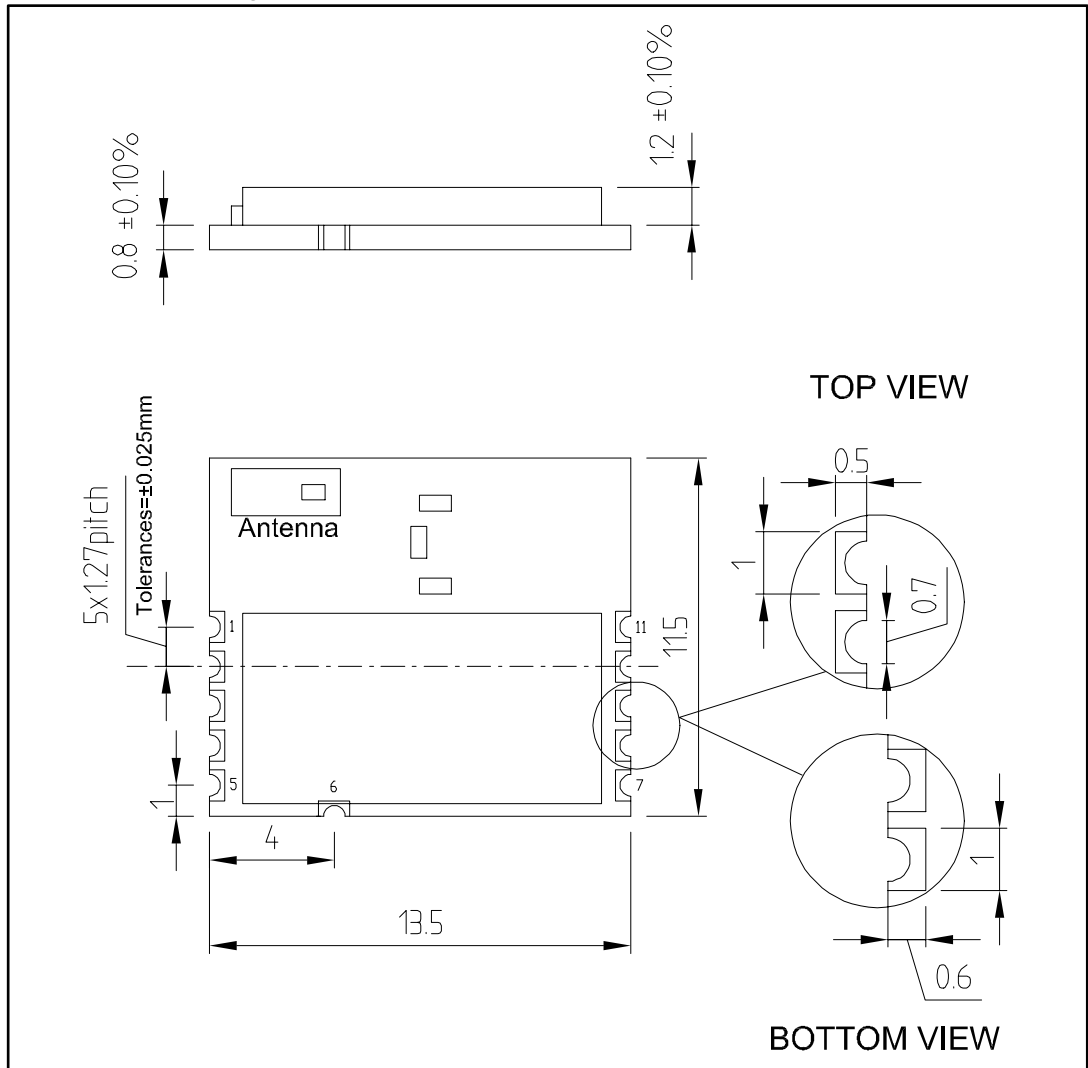
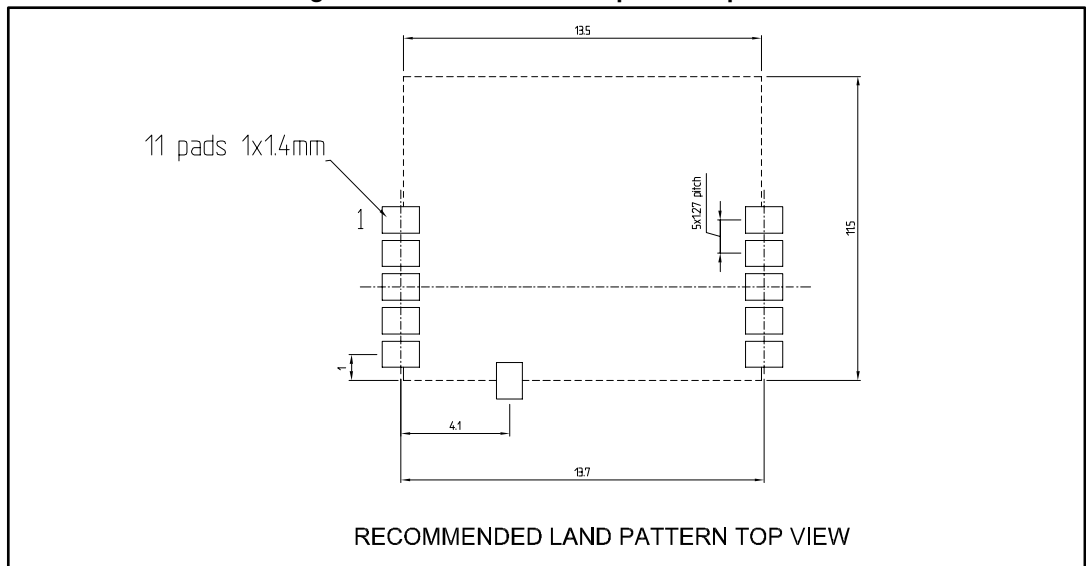

Figure 14: Recommend land pattern top view



6 Hardware design

SPBTLE-RF0 module supports SPI hardware interfaces.



- All unused pins should be left floating; do not ground
- All GND pins must be well grounded
- The area around the module should be free of any ground planes, power planes, trace routings, or metal for 6 mm from the module antenna position, in all directions.
- Traces should not be routed underneath the module
- Reset pin must be keep low until Vin is stable

6.1 Reflow soldering

The SPBTLE-RF0 is a high temperature strength surface mount Bluetooth® module supplied on an 11-pin, 4-layer PCB. The recommended final assembly reflow profiles are indicated below.

The soldering phase must be executed with care: pay special attention to the set up of the peak temperature to avoid undesired melting.

Below are some soldering profile recommendations.

Table 5: Soldering

Profile feature	Pb-free assembly
Average ramp up rate ($T_{S_{MAX}}$ to T_P)	3 °C / sec max
Preheat	
Temperature min (T_S min)	150 °C
Temperature max (T_S max)	200 °C
Time (t_s min to t_s max) (t_s)	60 - 100 sec
Time maintained above	
Temperature T_L	217 °C
Time t_L	60 - 70 sec
Peak temperature (T_P)	240 + 0 °C
Time within 5 °C of actual peak temperature (T_P)	10 - 20 sec
Ramp down rate	6 °C / sec
Time from 25 °C to peak temperature	8 minutes max

Figure 15: Soldering profiles

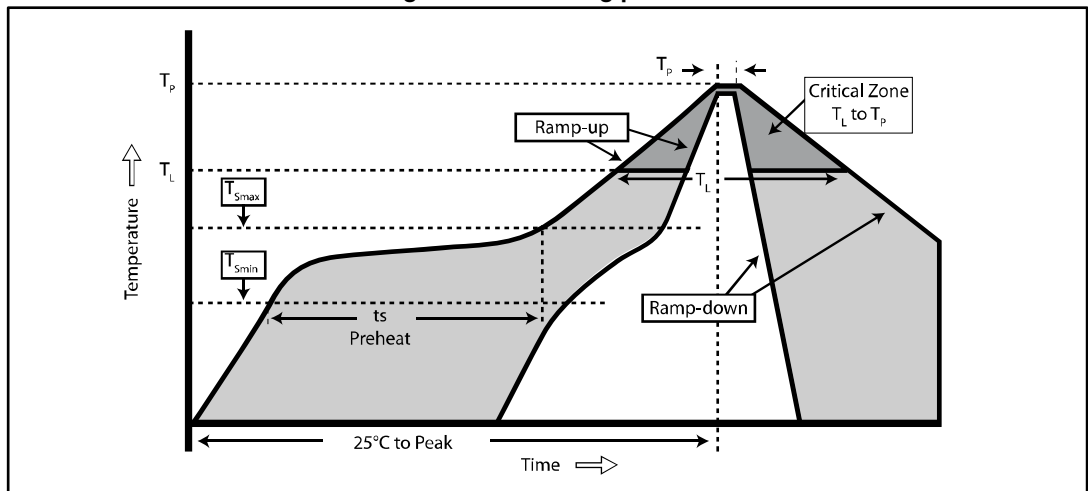

7 Regulatory compliance

7.1 FCC certification

This module has been tested and found to comply with the FCC part 15 rules. These limits are designed to provide reasonable protection against harmful interference in approved installations. This equipment generates, uses, and can radiate radio frequency energy and, if not installed and used in accordance with the instructions, may cause harmful interference to radio communications.

However, there is no guarantee that interference may not occur in a particular installation.

This device complies with part 15 of the FCC rules. Operation is subject to the following two conditions:

1. This device may not cause harmful interference, and
2. this device must accept any interference received, including interference that may cause undesired operation.

Modifications or changes to this equipment not expressly approved by STMicroelectronics may render void the user's authority to operate this equipment.

Modular approval

FCC ID: S9NSPBTLERF

In accordance with FCC part 15, the SPBTLE-RF0 is listed as a modular transmitter device.

This module is evaluated for stand-alone use only. Finished products incorporating multiple transmitters must comply with collocation and RF exposure requirements in accordance with FCC multi-transmitter product procedures. Collocated transmitters operating in portable RF Exposure conditions (e.g. < 20 cm from persons including but not limited to body worn and hand held devices) may require separate approval.

7.1.1 Labeling instructions

When integrating the SPBTLE-RF0 into the final product, the OEM must ensure that the FCC labeling requirements are satisfied. A statement must be included on the exterior of the final product which indicates the product includes a certified module. The label should state the following (or similar wording that conveys the same meaning):

Contains FCC ID: S9NSPBTLERF

OR

This product contains FCC ID: S9NSPBTLERF

The OEM must include the following statements on the exterior of the final product unless the product is too small (e.g. less than 4 x 4 inches):

This device complies with Part 15 of the FCC Rules. Operation is subject to the following two conditions:

- this device may not cause harmful interference, and
- this device must accept any interference received, including any interference that may cause undesired operation.

7.1.2 Product manual instructions

This section applies to OEM final products containing the SPBTLE-RF0 module, subject to FCC compliance. The final product manual must contain the following statement (or a similar statement that conveys the same meaning):



Changes or modifications not expressly approved by the party responsible for compliance could void the user's authority to operate the equipment. (Part. 15.21)

In the case where an OEM seeks Class B (residential) limits for the final product, the following statement must be included in the final product manual:



This equipment has been tested and found to comply with the limits for a Class B digital device, pursuant to part 15 of the FCC Rules. These limits are designed to provide reasonable protection against harmful interference in a residential installation. This equipment generates, uses and can radiate radio frequency energy and, if not installed and used in accordance with the instructions, may cause harmful interference to radio communications. However, there is no guarantee that interference will not occur in a particular installation. If this equipment does cause harmful interference to radio or television reception, which can be determined by turning the equipment off and on, the user is encouraged to try to correct the interference by one or more of the following measures:

- Reorient or relocate the receiving antenna
- Increase the separation between the equipment and receiver
- Connect the equipment into an outlet on a circuit different from that to which the receiver is connected
- Consult the dealer or an experienced radio/TV technician for help

In the case where an OEM seeks the lesser category of a Class A digital device for the final product, the following statement must be included in the final product manual:



This equipment has been tested and found to comply with the limits for a Class A digital device, pursuant to part 15 of the FCC Rules. These limits are designed to provide reasonable protection against harmful interference when the equipment is operated in a commercial environment. This equipment generates, uses, and can radiate radio frequency energy and, if not installed and used in accordance with the instruction manual, may cause harmful interference to radio communications. Operation of this equipment in a residential area is likely to cause harmful interference in which case the user will be required to correct the interference at his expense.

For more information refer to Test Report No. AR16-0006125-01 performed in accordance with:

- FCC Rules: Code of Federal Regulations (CFR) no. 47 Part 15 subpart C Section 15.247

7.2 IC certification

The SPBTLE-RF0 module has been tested and found compliant with the IC RSS-210 rules.

These limits are designed to provide reasonable protection against harmful interference in approved installations. This equipment generates, uses, and can radiate radio frequency energy and, if not installed and used in accordance with the instructions, may cause harmful interference to radio communications.

However, there is no guarantee that interference may not occur in a particular installation.

This device complies with RSS-210 of the IC rules. Operation is subject to the following two conditions:

- this device may not cause harmful interference and
- this device must accept any interference received, including interference that may cause undesired operation

Modifications or changes to this equipment not expressly approved by STMicroelectronics may render void the user's authority to operate this equipment.

Modular approval

IC: 8976C-SPBTLERF

In accordance with IC RSS-210, the SPBTLE-RF0 is listed as a modular transmitter device.

This module is evaluated for stand-alone use only. Finished products incorporating multiple transmitters must comply with collocation and RF exposure requirements in accordance with IC multi-transmitter product procedures. Collocated transmitters operating in portable RF Exposure conditions (e.g. < 20 cm from persons including but not limited to body worn and hand held devices) may require separate approval.

7.2.1 Labelling instructions

When integrating the SPBTLE-RF0 into the final product, the OEM must ensure that the IC labeling requirements are satisfied. A statement must be included on the exterior of the final product which indicates that the product includes a certified module. The label should state the following (or similar wording that conveys the same meaning):

Contains IC: 8976C-SPBTLERF

OR

This product contains IC: 8976C-SPBTLERF

The OEM must include the following statements on the exterior of the final product unless the product is too small (e.g. less than 4 x 4 inches):

This device complies with RSS-210 of the IC Rules. Operation is subject to the following two conditions:

- this device may not cause harmful interference and
- this device must accept any interference received, including any interference that may cause undesired operation

7.2.2 Product manual instructions

This section applies to OEM final products containing the SPBTLE-RF0 module, subject to IC compliance. The final product manual must contain the following statement (or a similar statement that conveys the same meaning):



Changes or modifications not expressly approved by the party responsible for compliance could void the user's authority to operate the equipment. (RSS-210)

In the case where an OEM seeks Class B (residential) limits for the final product, the following statement must be included in the final product manual:



This equipment has been tested and found to comply with the limits for a Class B digital device, pursuant to RSS-210 of the IC Rules. These limits are designed to provide reasonable protection against harmful interference in a residential installation. This equipment generates, uses and can radiate radio frequency energy and, if not installed and used in accordance with the instructions, may cause harmful interference to radio communications. However, there is no guarantee that interference will not occur in a particular installation. If this equipment does cause harmful interference to radio or television reception, which can be determined by turning the equipment off and on, the user is encouraged to try to correct the interference by one or more of the following measures:

- Reorient or relocate the receiving antenna
- Increase the separation between the equipment and receiver
- Connect the equipment into an outlet on a circuit different from that to which the receiver is connected
- Consult the dealer or an experienced radio/TV technician for help

In the case where an OEM seeks the lesser category of a Class A digital device for the final product, the following statement must be included in the final product manual:



This equipment has been tested and found to comply with the limits for a Class A digital device, pursuant to RSS-210 of the IC Rules. These limits are designed to provide reasonable protection against harmful interference when the equipment is operated in a commercial environment. This equipment generates, uses, and can radiate radio frequency energy and, if not installed and used in accordance with the instruction manual, may cause harmful interference to radio communications. Operation of this equipment in a residential area is likely to cause harmful interference in which case the user will be required to correct the interference at his expense.

For more information refer to Test Report No. AR16-0006125-02 performed in accordance with:

- INDUSTRY CANADA Spectrum Management and Telecommunications Radio Standards Specification
- RSS-210:210 Licence-exempt Radiocommunication Devices (All Frequency Bands): Category I Equipment
- RSS-247:2015 Digital Transmission Systems (DTSs), Frequency Hopping Systems (FHSs) and Licence-Exempt Local Area Network (LE-LAN) Devices

7.3 CE certification for SPBTLE-RF0 module

The SPBTLE-RF0 module has been certified according to the following standards:

- EN 60950-1:2006 + A11:2009 + A1:2010 + A12:2011 + A2:2013
- EN 62479:2010
- ETSI EN 301 489-1 V1.9.2:2011
- ETSI EN 301 489-1 V1.8.1
- ETSI EN 301 489-17 V3.1.1 (2017-02)
- ETSI EN 300 328 V2.1.1 (2016:11)

The module is CE certified:

Figure 16: CE certified



7.4 Bluetooth certification

The module with embedded stack and profile has been qualified in accordance with the Bluetooth Special Interest Group (BT SIG) qualification rules:

- Declaration ID: D028766
- Qualified design ID: 71984
- Product type: End Product
- Core spec version: 4.1
- Product description: Bluetooth Low Energy v4.1 module

SPBTLE-RF0 module listing information can be found at:

https://www.bluetooth.org/tpg/QLI_viewQDL.cfm?qid=28766

8 Ordering information

Table 6: Ordering information

Order code	Description	Packing	MOQ
SPBTLE-RF0	Bluetooth® V4.1 Low Energy module	JEDEC tray	2448 pcs
SPBTLE-RF0TR	Bluetooth® V4.1 Low Energy module	Tape and reel	1000 pcs