



Chipsmall Limited consists of a professional team with an average of over 10 year of expertise in the distribution of electronic components. Based in Hongkong, we have already established firm and mutual-benefit business relationships with customers from,Europe,America and south Asia,supplying obsolete and hard-to-find components to meet their specific needs.

With the principle of “Quality Parts,Customers Priority,Honest Operation,and Considerate Service”,our business mainly focus on the distribution of electronic components. Line cards we deal with include Microchip,ALPS,ROHM,Xilinx,Pulse,ON,Everlight and Freescale. Main products comprise IC,Modules,Potentiometer,IC Socket,Relay,Connector.Our parts cover such applications as commercial,industrial, and automotives areas.

We are looking forward to setting up business relationship with you and hope to provide you with the best service and solution. Let us make a better world for our industry!



Contact us

Tel: +86-755-8981 8866 Fax: +86-755-8427 6832

Email & Skype: info@chipsmall.com Web: www.chipsmall.com

Address: A1208, Overseas Decoration Building, #122 Zhenhua RD., Futian, Shenzhen, China



High Voltage LED Series Chip on Board

LC013D–Gen.2



High efficacy COB LED package
well-suited for use in spotlight applications

Features & Benefits

- Chip on Board (COB) solution makes it easy to design in
- Simple assembly reduces manufacturing cost
- Low thermal resistance
- InGaN/GaN MQW LED with long time reliability

Applications

- Spotlight / Downlight
- LED Retrofit Bulbs
- Outdoor Illumination



Table of Contents

1.	Characteristics	-----	3
2.	Product Code Information	-----	5
3.	Typical Characteristics Graphs	-----	8
4.	Outline Drawing & Dimension	-----	10
5.	Reliability Test Items & Conditions	-----	11
6.	Label Structure	-----	12
7.	Packing structure	-----	13
8.	Precautions in Handling & Use	-----	14

1. Characteristics

a) Absolute Maximum Rating

Item	Symbol	Rating	Unit	Condition
Ambient / Operating Temperature	T_a	-40 ~ +105	°C	-
Storage Temperature	T_{stg}	-40 ~ +120	°C	-
LED Junction Temperature	T_J	150	°C	-
Case Temperature	T_C	115	°C	-
Forward Current	I_F	920	mA	-
Power Dissipation	P_D	34.5	W	-
ESD (HBM)	-	±2	kV	-
ESD (MM)	-	±0.5	kV	-

b) Electro-optical Characteristics ($I_F = 360 \text{ mA}$, $T_J = 85 \text{ °C}$)

Item	Unit	Rank	Min.	Typ.	Max.
Forward Voltage (V_F)	V	YZ	31.8	34.6	37.5
Color Rendering Index (R_a)	-	3	70	-	-
		5	80	-	-
		7	90	-	-
Thermal Resistance (junction to case point)	°C/W		-	0.85	-
Beam Angle	°		-	115	-
Nominal Power	W			12.5	

Notes:

- 1) The COB is tested in pulsed condition at rated test current (10 ms pulse width) and rated temperature ($T_J = T_C = T_a = 85 \text{ °C}$)
- 2) Samsung maintains measurement tolerance of: forward voltage = $\pm 5 \%$, CRI = ± 1
- 3) Refer to the derating curve, '3. Typical Characteristics Graph'designed within the range.

c) Luminous Flux Characteristics (I_F = 360 mA)

CRI (R _a) Min.	Nominal CCT (K)	Flux Rank	Flux@ T _c = 85 °C (lm)		
			Min.	Typ.	Max.
70	3000	D2	1905	2006	-
	4000	D2	1966	2070	-
	5000	D2	1997	2102	-
80	2700	D2	1676	1764	-
	3000	D2	1764	1857	-
	3500	D2	1819	1915	-
	4000	D2	1852	1950	-
	5000	D2	1869	1967	-
	5700	D2	1869	1967	-
	6500	D2	1841	1938	-
90	2700	D2	1433	1509	-
	3000	D2	1501	1580	-
	3500	D2	1554	1635	-
	4000	D2	1587	1670	-
	5000	D2	1591	1674	-

Notes:

- 1) The COB is tested in pulsed operating condition at rated test current (10 ms pulse width) and rated temperature (T_J = T_C = 85 °C).
- 2) Samsung maintains measurement tolerance of: Luminous flux = ±7 %, CRI = ±1

2. Product Code Information

1	2	3	4	5	6	7	8	9	10	11	12	13	14	15	16	17	18
S	P	H	W	H	A	H	D	N	D	2	5	Y	Z	W	3	D	2

Digit	PKG Information	Code	Specification
1 2 3	Samsung Package High Power	SPH	
4 5	Color	WH	White
6	Product Version	A	
7 8	Form Factor	HD	COB
9	Lens Type	N	No lens
10	Wattage or Model	D	LC013D
11	Internal Code	2	
12	CRI & Sorting Temperature	3	Min. 70 (85°C)
		5	Min. 80 (85°C)
		7	Min. 90 (85°C)
13 14	Forward Voltage (V)	YZ	31.8~37.5
15	CCT (K)	W	2700K
		V	3000K
		U	3500K
		T	4000K
		R	5000K
		Q	5700K
		P	6500K
16	MacAdam Step	2	MacAdam 2-step
		3	MacAdam 3-step
17 18	Luminous Flux (Lm)	D2	COB D-series Gen.2 level

a) Binning Structure ($I_F = 360 \text{ mA}$, $T_J = 85 \text{ }^\circ\text{C}$)

CRI(R _a) Min.	Nominal CCT(K)	Product Code	V _F Rank	Color Rank	Flux Rank	Flux Range (Φ _v , lm)
70	3000	SPHWAHDND23YZV3D2	YZ	V3	D2	1905 ~
	4000	SPHWAHDND23YZT3D2	YZ	T3	D2	1966 ~
	5000	SPHWAHDND23YZR3D2	YZ	R3	D2	1997 ~
80	2700	SPHWAHDND25YZW2D2	YZ	W2	D2	1676 ~
		SPHWAHDND25YZW3D2		W3		
	3000	SPHWAHDND25YZV2D2	YZ	V2	D2	1764 ~
		SPHWAHDND25YZV3D2		V3		
	3500	SPHWAHDND25YZU2D2	YZ	U2	D2	1819 ~
		SPHWAHDND25YZU3D2		U3		
	4000	SPHWAHDND25YZT2D2	YZ	T2	D2	1852 ~
		SPHWAHDND25YZT3D2		T3		
	5000	SPHWAHDND25YZR3D2	YZ	R3	D2	1869 ~
	5700	SPHWAHDND25YZQ3D2	YZ	Q3	D2	1869 ~
	6500	SPHWAHDND25YZP3D2	YZ	P3	D2	1841 ~
	90	2700	SPHWAHDND27YZW2D2	YZ	W2	D2
SPHWAHDND27YZW3D2			W3			
3000		SPHWAHDND27YZV2D2	YZ	V2	D2	1501 ~
		SPHWAHDND27YZV3D2		V3		
3500		SPHWAHDND27YZU2D2	YZ	U2	D2	1554 ~
		SPHWAHDND27YZU3D2		U3		
4000		SPHWAHDND27YZT2D2	YZ	T2	D2	1587 ~
		SPHWAHDND27YZT3D2		T3		
5000		SPHWAHDND27YZR3D2	YZ	R3	D2	1591 ~

b) Chromaticity Region & Coordinates ($I_F = 360 \text{ mA}$, $T_J = 85 \text{ }^\circ\text{C}$)

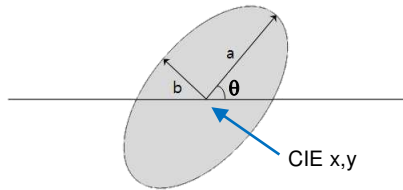
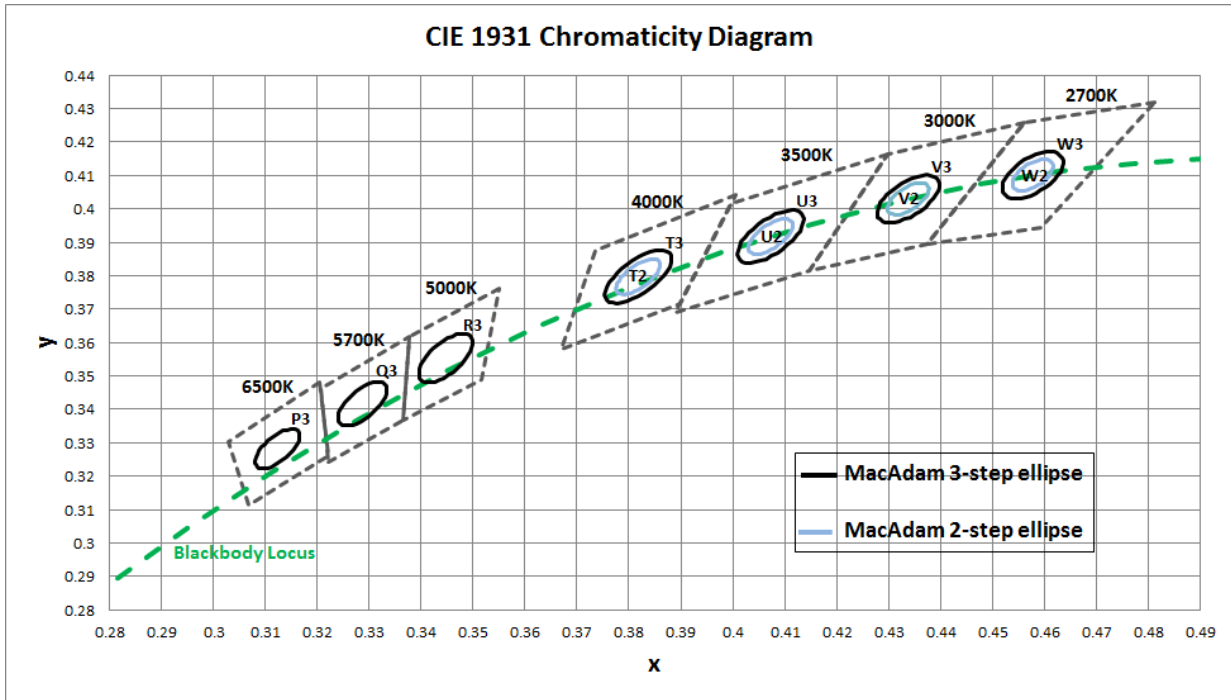

MacAdam Ellipse (W2, W3)					
Step	CIE x	CIE y	θ	a	b
2-step	0.4578	0.4101	53.70	0.0054	0.0028
3-step	0.4578	0.4101	53.70	0.0081	0.0042

MacAdam Ellipse (V2, V3)					
Step	CIE x	CIE y	θ	a	b
2-step	0.4338	0.403	53.22	0.0056	0.0027
3-step	0.4338	0.4030	53.22	0.0083	0.0041

MacAdam Ellipse (U2, U3)					
Step	CIE x	CIE y	θ	a	b
2-step	0.4073	0.3917	54.00	0.0062	0.0028
3-step	0.4073	0.3917	54.00	0.0093	0.0041

MacAdam Ellipse (T2, T3)					
Step	CIE x	CIE y	θ	a	b
2-step	0.3818	0.3797	53.72	0.0063	0.0027
3-step	0.3818	0.3797	53.72	0.0094	0.0040

MacAdam Ellipse (R3)					
Step	CIE x	CIE y	θ	a	b
3-step	0.3447	0.3553	59.62	0.0082	0.0035

MacAdam Ellipse (Q3)					
Step	CIE x	CIE y	θ	a	b
3-step	0.3287	0.3417	59.0950	0.0075	0.0032

MacAdam Ellipse (P3)					
Step	CIE x	CIE y	θ	a	b
3-step	0.3123	0.3282	58.5700	0.0067	0.0029

Note:

Samsung maintains measurement tolerance of: $C_x, C_y = \pm 0.005$

3. Typical Characteristics Graphs

a) Spectrum Distribution ($I_f = 360\text{mA}$, $T_J = 85^\circ\text{C}$)

CRI Ra 80+

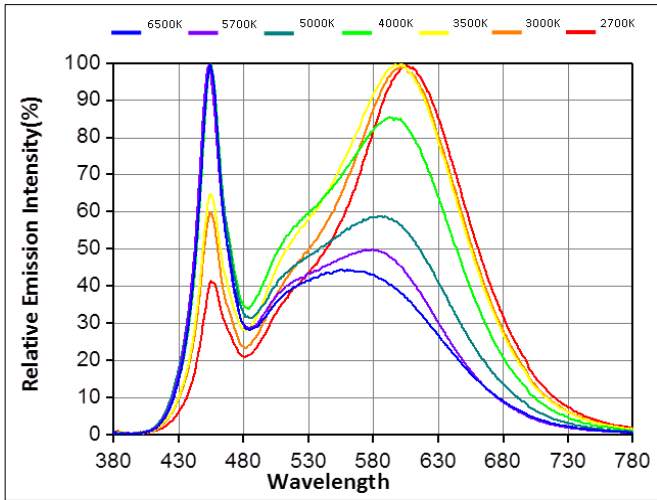

CRI Ra 90+

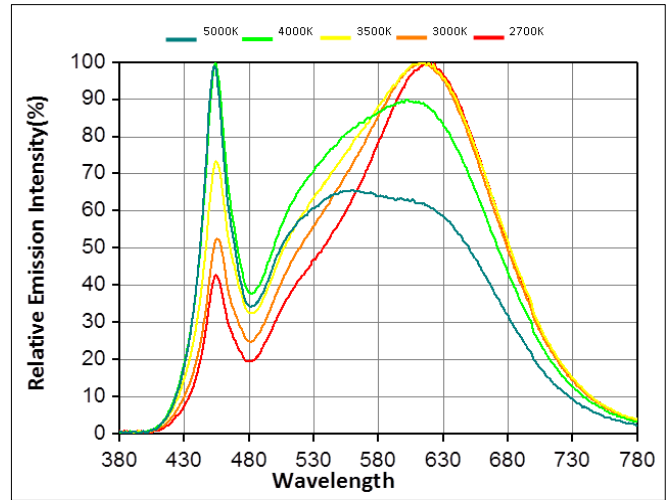

CRI Ra 70+

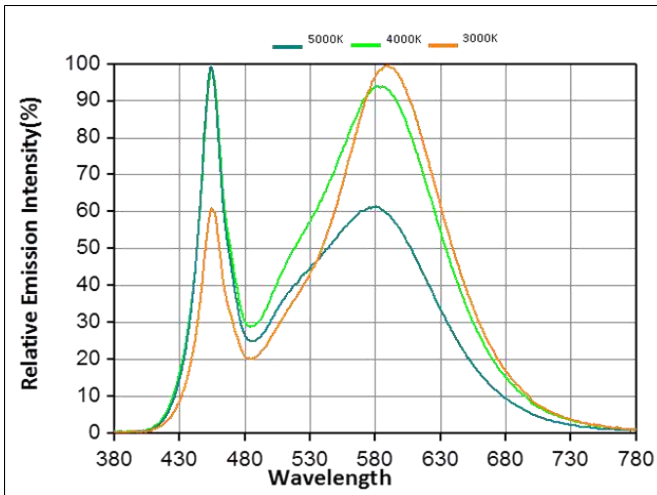

b) Forward Current Characteristics ($T_J = 85^\circ\text{C}$)

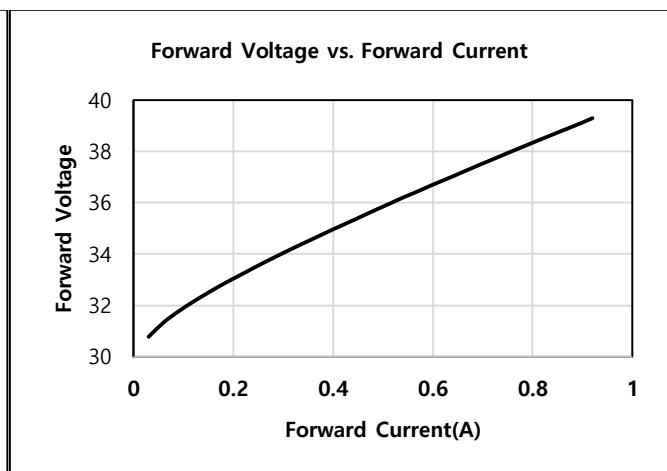
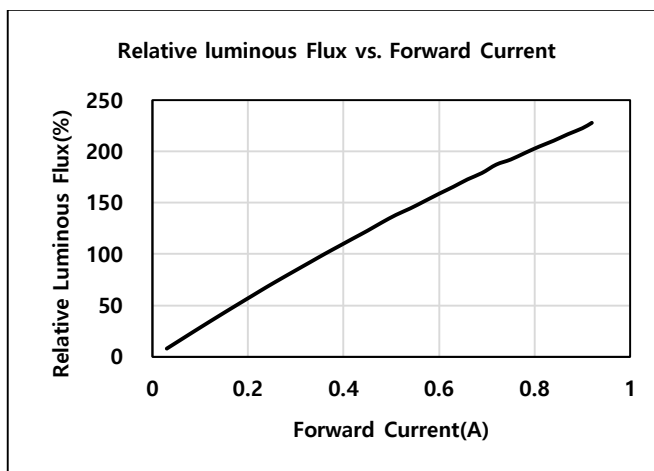

c) Temperature Characteristics ($I_f = 360\text{mA}$)

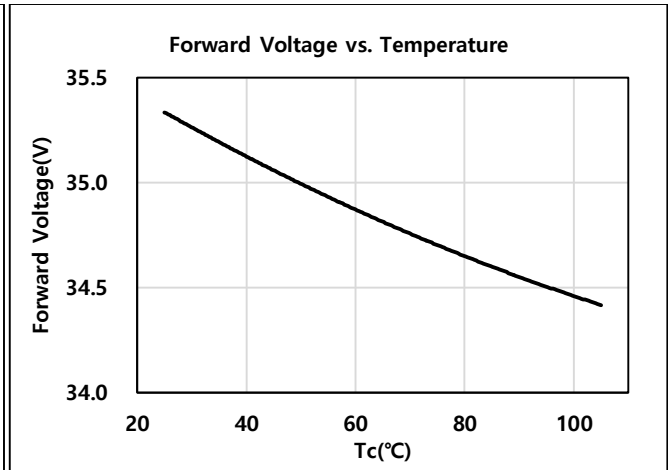
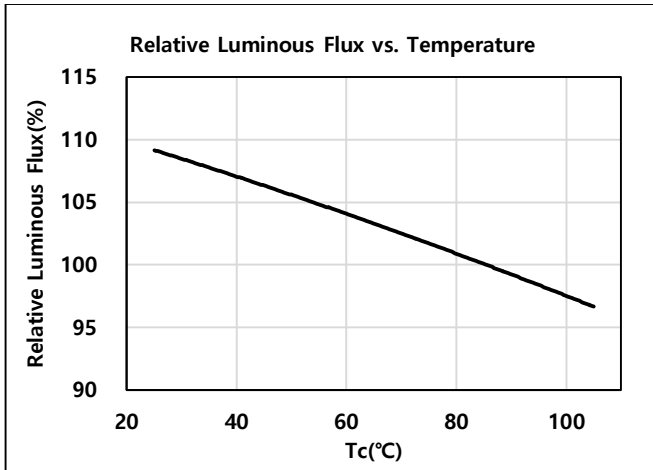

d) Color Shift Characteristics ($T_J = 85\text{ }^\circ\text{C}, I_f = 360\text{mA}, \text{CRI} = 80+$)

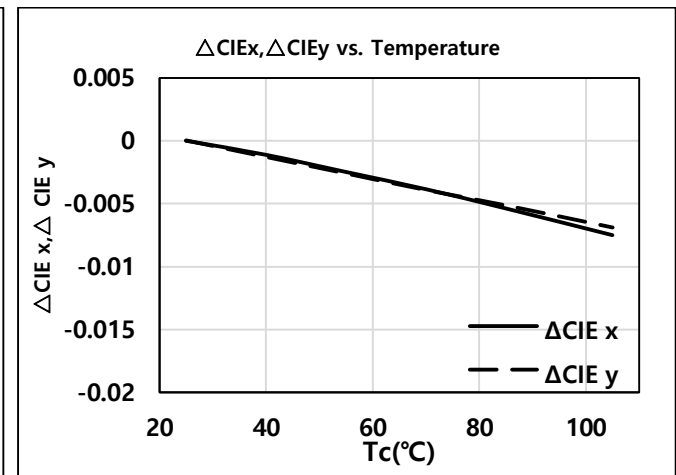
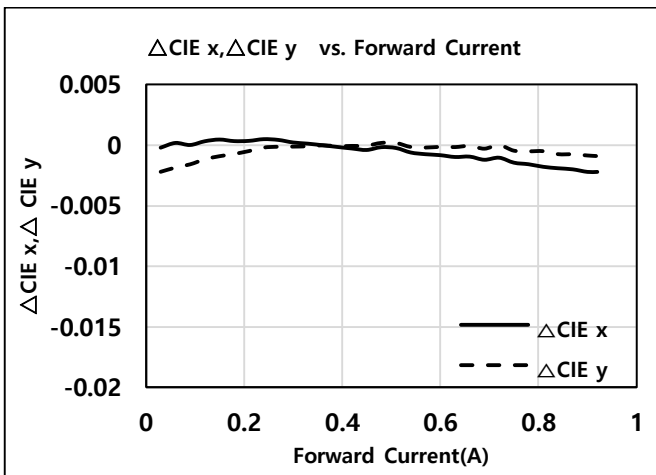

e) Beam Angle Characteristics ($I_f = 360\text{ mA}, T_J = 85\text{ }^\circ\text{C}$)

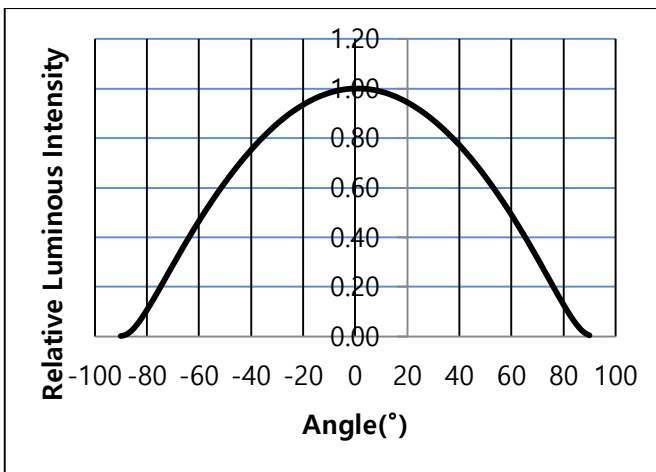

f) Derating Characteristics

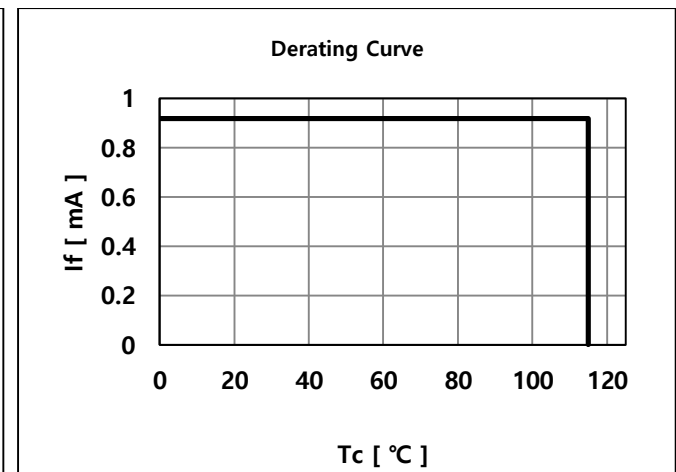

4. Outline Drawing & Dimension

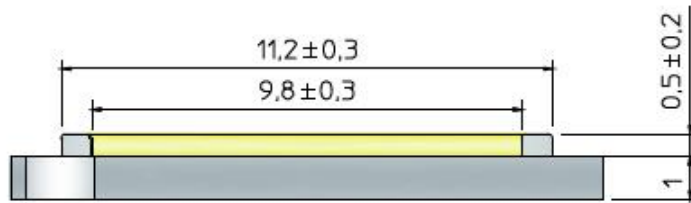
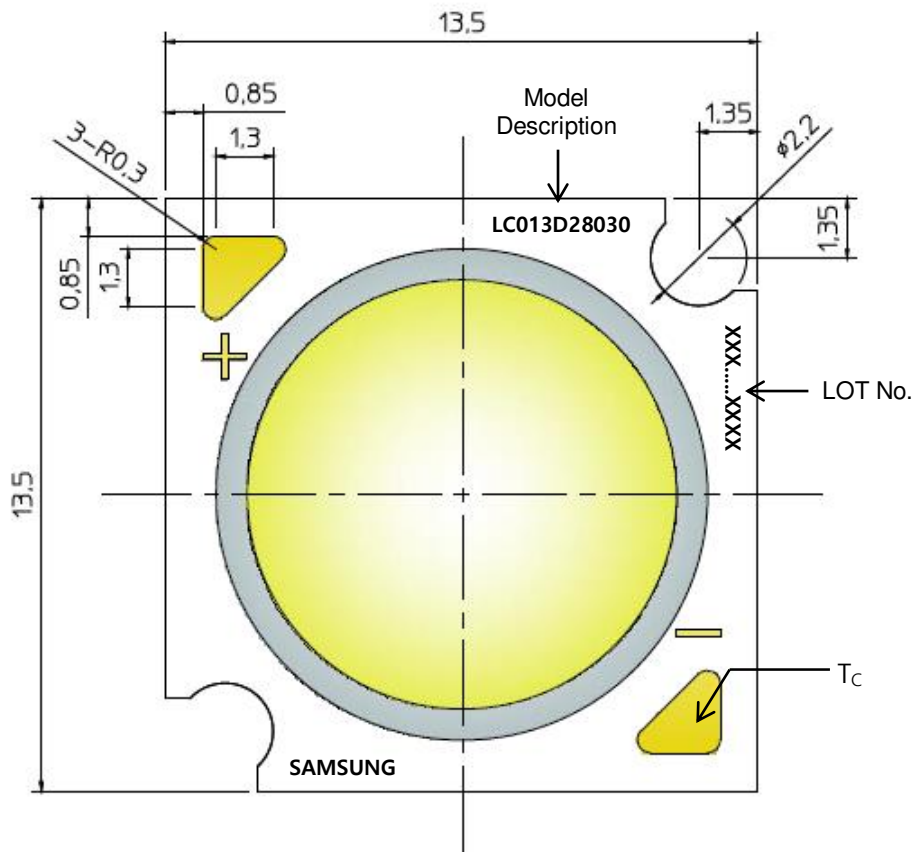

- 1. Unit: mm
- 2. Tolerance: ± 0.30 mm

Item	Dimension	Tolerance	Unit
Length	13.5	±0.30	mm
Width	13.5	±0.30	mm
Height	1.50	±0.20	mm
Light Emitting Surface (LES) Diameter	9.8	±0.30	mm

Note: Denoted product information above is only an example
 (LC013D28030 : LC013D, Gen2, CRI80+, 3000K)

5. Reliability Test Items & Conditions

a) Test Items

Test Item	Test Condition	Test Hour / Cycle
High Temperature Humidity Life Test	60 °C, 90 % RH., DC Derating, I _F	1000 h
High Temperature Life Test	85 °C, DC Derating, I _F	1000 h
Low Temperature Life Test	-40 °C, DC, Derating I _F	1000 h
High Temperature Storage	120 °C	1000 h
Low Temperature Storage	-40 °C	1000 h
Temperature Humidity Storage	60 °C, 90% RH	1000h
TemperatureCycle On/Off Test	-40 °C/ 85 °C each 20 min, 30 min transfer power on/off each 5 min, DC Derating, I _F = max	100 cycles
ESD (HBM)	R ₁ : 10 MΩ R ₂ : 1.5 kΩ C: 100 pF	5 times
ESD (MM)	R ₁ : 10 MΩ R ₂ : 0 kΩ C: 200 pF	5 times
Vibration Test	20~ 80 Hz (displacement: 0.06 inch, max. 20 g) 80 ~ 2 kHz (max. 20 g) min. frequency ↔ max. frequency 4 min transfer	4 times
Mechanical Shock Test	1500g, 0.5 ms each of the 6 surfaces (3 axis x 2 sides)	5 times
Sulfur Resistance	25 °C, 75%, H2S 15 ppm	504h

b) Criteria for Judging the Damage

Item	Symbol	Test Condition (T _c = 25 °C)	Limit	
			Min.	Max.
Forward Voltage	V _F	I _F = 360 mA	L.S.L. * 0.9	U.S.L. * 1.1
Luminous Flux	Φ _v	I _F = 360 mA	L.S.L. * 0.7	U.S.L. * 1.3

6. Label Structure

a) Label Structure

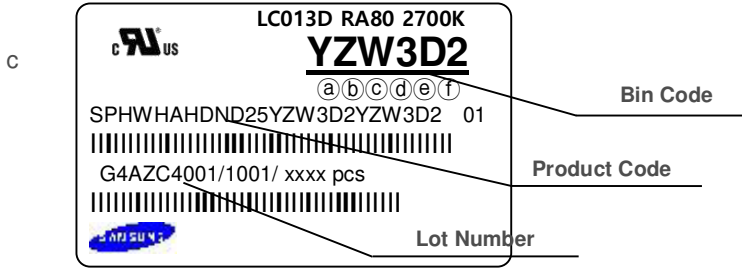

Note: Denoted bincode and product code above is only an example (see description on page 5)

Bin Code:

- ⒶⒷ: Forward Voltagebin (refer to page11)
- ⒸⒹ: Chromaticitybin (refer to page 9-10)
- ⒺⒻ: Luminous Fluxbin (refer to page 6)

b) Lot Number

The lot number is composed of the following characters:

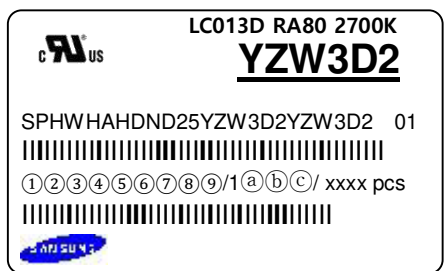

- ① ③④⑤⑥⑦⑧⑨ / 1ⒶⒷⒸ / xxxx pcs
- ① : Production site (S: Giheung, Korea, G: Tianjin, China)
- ② : 4(LED)
- ③ : Product state (A: Normal, B: Bulk, C: First Production, R: Reproduction, S: Sample)
- ④ : Year (Z: 2015, A: 2016, B: 2017...)
- ⑤ : Month (1~9, A, B, C)
- ⑥⑦⑧⑨ : Day (1~9, A, B~V)
- ⒶⒷⒸ : Product serial number (001 ~ 999)

7. Packing Structure

Packing material	Max. quantity in pcs of COB	Dimension(mm)			Tolerance
		Length	Width	Height	
Tray	50	200	200	8	1
Anti-Static Bag	250 (5 trays)	320	270	-	+/- 0.5
Outer Box (Small)	500 (2 bags)	225	225	65	5
Outer Box (Middle)	1000 (4 bags)	225	225	130	5

a) Packing Structure

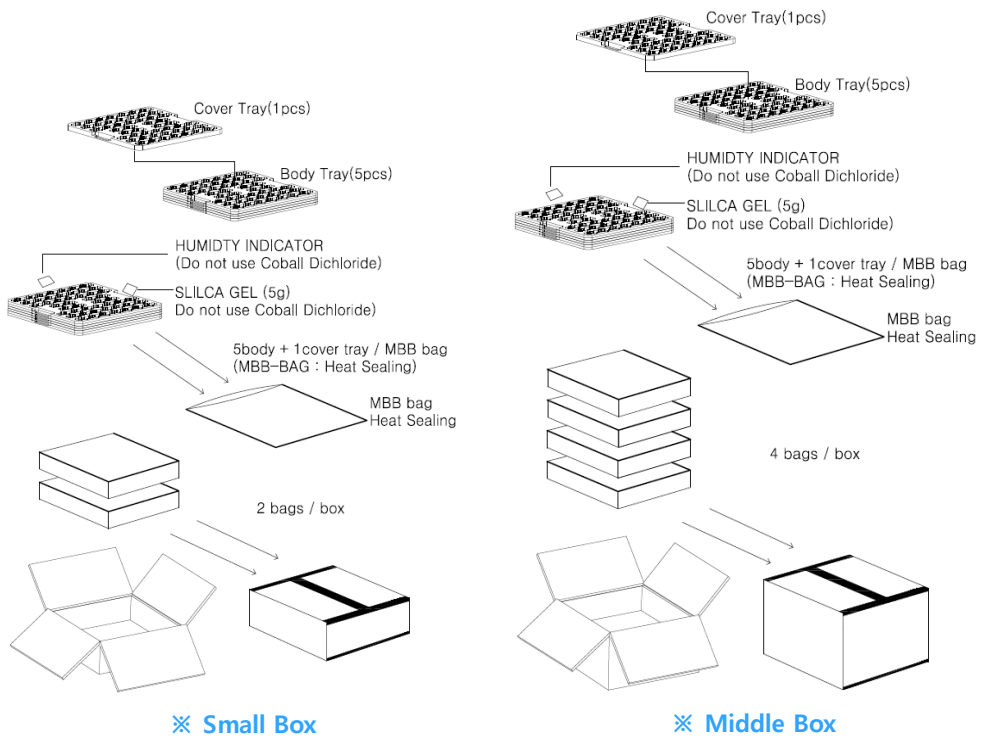

b) Tray

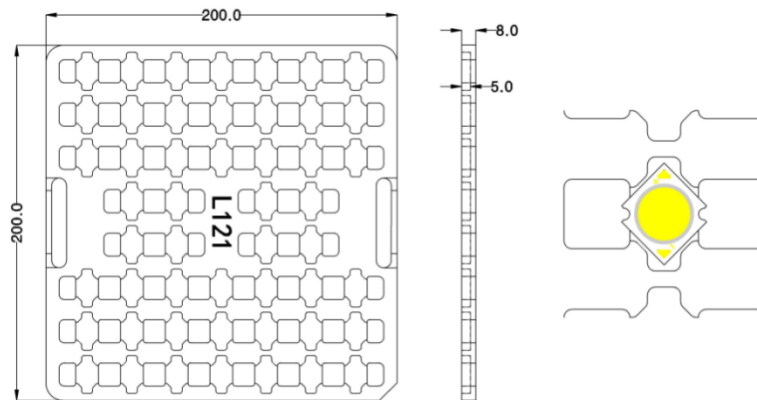

8. Precautions in Handling & Use

- 1) This device should not be used in any type of fluid such as water, oil, organic solvent, etc. When cleaning is required, IPA is recommended as the cleaning agent. Some solvent-based cleaning agent may damage the silicone resins used in the device.
- 2) LEDs must be stored in a clean environment. If the LEDs are to be stored for three months or more after being shipped from Samsung, they should be packed with a nitrogen-filled container (shelf life of sealed bags is 12 months at temperature 0~40 °C, 0~90 % RH).
- 3) After storage bag is opened, device subjected to soldering, solder reflow, or other high temperature processes must be:
 - a. Mounted within 672 hours (28 days) at an assembly line with a condition of no more than 30 °C / 60 % RH, or
 - b. Stored at <10 % RH
- 4) Repack unused products with anti-moisture packing, fold to close any opening and then store in a dry place.
- 5) Devices require baking before mounting, if humidity card reading is >60 % at 23 ± 5 °C.
- 6) Devices must be baked for 1 hour at 60 ± 5 °C, if baking is required.
- 7) The LEDs are sensitive to the static electricity and surge current. It is recommended to use a wrist band or anti-electrostatic glove when handling the LEDs. If voltage exceeding the absolute maximum rating is applied to LEDs, it may cause damage or even destruction to LED devices. Damaged LEDs may show some unusual characteristics such as increase in leakage current, lowered turn-on voltage, or abnormal lighting of LEDs at low current.
- 8) The thermal management is one of the most critical factors for the LED lighting system. Especially the LED junction temperature should not exceed the absolute maximum rating while operation of LED lighting system.
For more information, please refer to Application Note 'Mechanical & Thermal Guide for COB'.
- 9) In case of driving LEDs around the minimum current level (I_{f_min}), chips might exhibit different brightness due to the variation in I-V characteristics of each one. This is normal and does not adversely affect the performance of product.
- 10) VOCs (Volatile Organic Compounds) can be generated from adhesives, flux, hardener or organic additives used in luminaires (fixtures). Transparent LED silicone encapsulant is permeable to those chemicals and they may lead to a discoloration of encapsulant when they exposed to heat or light. This phenomenon can cause a significant loss of light emitted (output) from the luminaires. In order to prevent these problems, we recommend users to know the physical properties of materials used in luminaires and they must be carefully selected.
- 11) The resin area is very sensitive, please do not handle, press, touch, rub, clean, or pick by with tweezers on it. Instead, please pick at the handling area as indicated below.

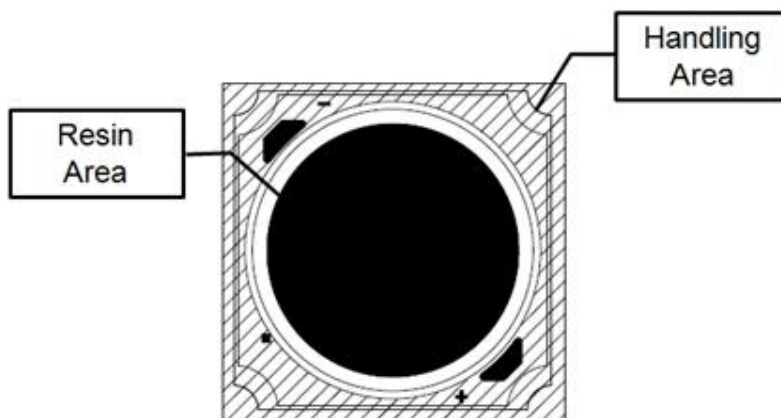

Legal and additional information.

[About Samsung Electronics Co., Ltd.](#)

Samsung Electronics Co., Ltd. inspires the world and shapes the future with transformative ideas and technologies, redefining the worlds of TVs, smartphones, wearable devices, tablets, cameras, digital appliances, printers, medical equipment, network systems and semiconductors.

We are also leading in the Internet of Things space through, among others, our Digital Health and Smart Home initiatives. We employ 307,000 people across 84 countries. To discover more, please visit our official website at www.samsung.com and our official blog at global.samsungtomorrow.com.

Copyright © 2015 Samsung Electronics Co., Ltd. All rights reserved.
Samsung is a registered trademark of Samsung Electronics Co., Ltd.
Specifications and designs are subject to change without notice. Non-metric weights and measurements are approximate. All data were deemed correct at time of creation. Samsung is not liable for errors or omissions. All brand, product, service names and logos are trademarks and/or registered trademarks of their respective owners and are hereby recognized and acknowledged.

Samsung Electronics Co., Ltd.
95, Samsung 2-ro
Giheung-gu
Yongin-si, Gyeonggi-do, 446-711
KOREA

www.samsungled.com

