



Chipsmall Limited consists of a professional team with an average of over 10 year of expertise in the distribution of electronic components. Based in Hongkong, we have already established firm and mutual-benefit business relationships with customers from,Europe,America and south Asia,supplying obsolete and hard-to-find components to meet their specific needs.

With the principle of “Quality Parts,Customers Priority,Honest Operation,and Considerate Service”,our business mainly focus on the distribution of electronic components. Line cards we deal with include Microchip,ALPS,ROHM,Xilinx,Pulse,ON,Everlight and Freescale. Main products comprise IC,Modules,Potentiometer,IC Socket,Relay,Connector.Our parts cover such applications as commercial,industrial, and automotives areas.

We are looking forward to setting up business relationship with you and hope to provide you with the best service and solution. Let us make a better world for our industry!



## Contact us

Tel: +86-755-8981 8866 Fax: +86-755-8427 6832

Email & Skype: info@chipsmall.com Web: www.chipsmall.com

Address: A1208, Overseas Decoration Building, #122 Zhenhua RD., Futian, Shenzhen, China



## High Power LED Series Chip on Board

# LC006B



High efficacy COB LED package,  
well-suited for use in spotlight applications

### Features & Benefits

- Chip on Board (COB) solution makes it easy to design in
- Simple assembly reduces manufacturing cost
- Low thermal resistance
- InGaN/GaN MQW LED with long time reliability
- Completed 6,000 hours of LM-80 Testing
- ENEC certified: Integral LED Module

### Applications

- Spotlight / Downlight
- LED Retrofit Bulbs
- Outdoor Illumination



## Table of Contents

1.	Characteristics	-----	3
2.	Product Code Information	-----	5
3.	Typical Characteristics Graphs	-----	10
4.	Outline Drawing & Dimension	-----	13
5.	Reliability Test Items & Conditions	-----	14
6.	Label Structure	-----	15
7.	Packing Structure	-----	17
8.	Precautions in Handling & Use	-----	20

## 1. Characteristics

### a) Absolute Maximum Rating

Item	Symbol	Rating	Unit	Condition
Ambient / Operating Temperature	$T_a$	-40 ~ +105	°C	-
Storage Temperature	$T_{stg}$	-40 ~ +120	°C	-
LED Junction Temperature	$T_j$	140	°C	-
Case Temperature	$T_c$	105	°C	*Note
Forward Current	$I_F$	320	mA	-
Power Dissipation	$P_D$	12.2	W	-
ESD (HBM)	-	±2	kV	-
ESD (MM)	-	±0.5	kV	-

### b) Electro-optical Characteristics ( $I_F = 180 \text{ mA}$ , $T_c = 25 \text{ °C}$ )

Item	Unit	Rank	Min.	Typ.	Max.
Forward Voltage ( $V_f$ )	V	YH	32.5	35.5	38.5
Color Rendering Index ( $R_a$ )	-	3	70	-	-
		5	80	-	-
		7	90	-	-
		8	95	-	-
Thermal Resistance (junction to chip point)	°C/W		-	2.4	-
Beam Angle	°		-	115	-
Working Voltage for Insulation	V				50
Nominal Power	W			6.4	
Eye Protection		Risk 1	-		-

#### Notes:

- 1) The COB is tested in pulsed condition at rated test current (10 ms pulse width) and rated temperature ( $T_j = T_c = T_a = 25 \text{ °C}$ )
- 2) Samsung maintains measurement tolerance of: forward voltage =  $\pm 5 \%$ , CRI =  $\pm 1$
- 3) Max  $T_c = 105 \text{ °C}$  (at max current) is for ENEC condition. Refer to the derating curve, '3. Typical Characteristics Graph' designed within the range.

**c) Luminous Flux Characteristics (I<sub>F</sub> = 180 mA, T<sub>c</sub> = 25 °C)**

CRI (R <sub>a</sub> ) Min.	Nominal CCT (K)	Flux Rank	Flux Bin	Sorting <sup>1)</sup> @ T <sub>c</sub> = 25 °C (lm)		Calculated Flux <sup>2)</sup> @ T <sub>c</sub> = 85 °C (lm)	
				Min.	Max.	Min.	Max.
70	3000	GE	G1	796	905	716	814
			G2	905	1013	814	912
	4000	GE	G1	836	950	752	855
			G2	950	1064	855	957
	5000	GE	G1	844	959	759	863
			G2	959	1074	863	967
80	2700	ED	E1	724	779	659	709
			E2	779	833	709	758
			E3	833	888	758	808
	3000	ED	E1	771	829	701	754
			E2	829	887	754	807
			E3	887	945	807	860
	3500	ED	E1	794	853	722	777
			E2	853	913	777	831
			E3	913	973	831	885
	4000	ED	E1	817	878	743	799
			E2	878	940	799	855
			E3	940	1001	855	911
	5000	ED	E1	825	887	750	807
			E2	887	949	807	863
			E3	949	1011	863	920
	5700	ED	E1	825	887	750	807
			E2	887	949	807	863
			E3	949	1011	863	920
90	2700	CF	C1	642	698	585	636
			C2	698	754	636	686
			C3	754	810	686	737
	3000	CF	C1	656	713	597	648
			C2	713	770	648	700
			C3	770	827	700	752
	3500	CF	C1	675	734	615	668
			C2	734	793	668	721
			C3	793	851	721	775
	4000	CF	C1	695	755	632	687
			C2	755	816	687	742
			C3	816	876	742	797
95	2700	CC	C1	566	629	515	572
			C2	629	691	572	629
	3000	CC	C1	583	648	531	590
			C2	648	713	590	649
	3500	CC	C1	601	667	547	607
			C2	667	734	607	668

**Notes:**

- 1) The COB is tested in pulsed condition at rated test current (10 ms pulse width) and rated temperature (T<sub>j</sub> = T<sub>c</sub> = T<sub>a</sub> = 25 °C)
- 2) Calculated flux values are for reference only
- 3) Samsung maintains measurement tolerance of: luminous flux = ±7 %, CRI = ±1



## 2. Product Code Information

1	2	3	4	5	6	7	8	9	10	11	12	13	14	15	16	17	18
S	P	H	C	W	1	H	D	N	8	2	5	Y	H	R	T	E	D

Digit	PKG Information	Code	Specification
1 2 3	Samsung Package High Power	<b>SPH</b>	
4 5	Color	<b>WW</b> <b>CW</b>	Warm White (T/U/V/W Ranks) Cool White (Q/R Ranks)
6	Product Version	<b>1</b>	
7 8	Form Factor	<b>HD</b>	COB
9	Lens Type	<b>N</b>	No lens
10	Internal Code	<b>8</b>	LC006
11	Chip Type	<b>2</b>	
12	CRI & Sorting Temperature	<b>3</b> <b>5</b> <b>7</b> <b>8</b>	Min. 70 Min. 80 Min. 90 Min 95 25 °C
13 14	Forward Voltage (V)	<b>YH</b>	32.5~38.5
15	CCT (K)	<b>W</b> <b>V</b> <b>U</b> <b>T</b> <b>R</b> <b>Q</b>	2700 K 3000 K 3500 K 4000 K 5000 K 5700 K WA, WB (MacAdam Ellipse) VA, VB (MacAdam Ellipse) UA, UB (MacAdam Ellipse) TA, TB (MacAdam Ellipse) RA (MacAdam Ellipse) Bin Code: VW, VX, VY, VZ (ANSI bin) TW, TX, TY, TZ (ANSI bin) RW, RX, RY, RZ (ANSI bin) QW, QX, QY, QZ (ANSI bin)
16	MacAdam / ANSI	<b>2</b> <b>3</b> <b>T</b>	MacAdam 2-step MacAdam 3-step ANSI bin
17 18	Luminous Flux	<b>GE</b> <b>ED</b> <b>CF</b> <b>CC</b>	G1, G2 (70 CRI) Bin Code: E1, E2, E3 (80 CRI) C2, C3, E1 (90 CRI) C1, C2 (95 CRI)

a) Binning Structure ( $I_F = 180 \text{ mA}$ ,  $T_c = 25 \text{ }^\circ\text{C}$ )

CRI (R <sub>a</sub> ) Min.	Nominal CCT (K)	Product Code	V <sub>f</sub> Rank	Color Rank	Chrom. Bin	Flux Rank	Flux Bin	Flux Range (Φ <sub>v</sub> , lm)
70	3000	SPHWW1HDN823YHVTGE	YH	VT	VW, VX VY, VZ	GE	G1	796 ~ 905
							G2	905 ~ 1013
	4000	SPHWW1HDN823YHTTGE	YH	TT	TW, TX TY, TZ	GE	G1	836 ~ 950
							G2	950 ~ 1064
	5000	SPHCW1HDN823YHRTGE	YH	RT	RW, RX RY, RZ	GE	G1	844 ~ 959
							G2	959 ~ 1074
80	2700	SPHWW1HDN825YHW2ED	YH	W2	WB	ED	E1	724 ~ 779
							E2	779 ~ 833
							E3	833 ~ 888
	3000	SPHWW1HDN825YHW3ED	YH	W3	WA, WB	ED	E1	724 ~ 779
							E2	779 ~ 833
							E3	833 ~ 888
	3500	SPHWW1HDN825YHV2ED	YH	V2	VB	ED	E1	771 ~ 829
							E2	829 ~ 887
							E3	887 ~ 945
	4000	SPHWW1HDN825YHV3ED	YH	V3	VA, VB	ED	E1	771 ~ 829
							E2	829 ~ 887
							E3	887 ~ 945
	4500	SPHWW1HDN825YHU2ED	YH	U2	UB	ED	E1	794 ~ 853
							E2	853 ~ 913
							E3	913 ~ 973
	5000	SPHWW1HDN825YHU3ED	YH	U3	UA, UB	ED	E1	794 ~ 853
							E2	853 ~ 913
							E3	913 ~ 973
	5500	SPHWW1HDN825YHT2ED	YH	T2	TB	ED	E1	817 ~ 878
							E2	878 ~ 940
							E3	940 ~ 1001
	6000	SPHWW1HDN825YHT3ED	YH	T3	TA, TB	ED	E1	817 ~ 878
							E2	878 ~ 940
							E3	940 ~ 1001
	6500	SPHCW1HDN825YHR3ED	YH	R3	RA	ED	E1	825 ~ 887
							E2	887 ~ 949
							E3	949 ~ 1011
	7000	SPHCW1HDN825YHRTED	YH	RT	RW, RX, RY, RZ	ED	E1	825 ~ 887
							E2	887 ~ 949
							E3	949 ~ 1011
7500	SPHCW1HDN825YHQTED	YH	QT	QW, QX, QY, QZ	ED	E1	825 ~ 887	
						E2	887 ~ 949	
						E3	949 ~ 1011	

a) Binning Structure ( $I_F = 180 \text{ mA}$ ,  $T_c = 25 \text{ }^\circ\text{C}$ )

CRI (R <sub>a</sub> ) Min.	Nominal CCT (K)	Product Code	V <sub>F</sub> Rank	Color Rank	Chrom. Bin	Flux Rank	Flux Bin	Flux Range (Φ <sub>v</sub> , lm)
90	2700	SPHWW1HDN827YHW2CF	YH	W2	WB	CF	C1	642 ~ 698
							C2	698 ~ 754
							C3	754 ~ 810
		SPHWW1HDN827YHW3CF	YH	W3	WA, WB	CF	C1	642 ~ 698
							C2	698 ~ 754
							C3	754 ~ 810
	3000	SPHWW1HDN827YHV2CF	YH	V2	VB	CF	C1	656 ~ 713
							C2	713 ~ 770
							C3	770 ~ 827
		SPHWW1HDN827YHV3CF	YH	V3	VA, VB	CF	C1	656 ~ 713
							C2	713 ~ 770
							C3	770 ~ 827
	3500	SPHWW1HDN827YHU2CF	YH	U2	UB	CF	C1	675 ~ 734
							C2	734 ~ 793
							C3	793 ~ 851
		SPHWW1HDN827YHU3CF	YH	U3	UA, UB	CF	C1	675 ~ 734
							C2	734 ~ 793
							C3	793 ~ 851
	4000	SPHWW1HDN827YHT2CF	YH	T2	TB	CF	C1	695 ~ 755
							C2	755 ~ 816
							C3	816 ~ 876
		SPHWW1HDN827YHT3CF	YH	T3	TA, TB	CF	C1	695 ~ 755
							C2	755 ~ 816
							C3	816 ~ 876
95	2700	SPHWW1HDN828YHW2CC	YH	W2	WB	CC	C1	566 ~ 629
							C2	629 ~ 691
		SPHWW1HDN828YHW3CC	YH	W3	WA, WB	CC	C1	566 ~ 629
							C2	629 ~ 691
	3000	SPHWW1HDN828YHV2CC	YH	V2	VB	CC	C1	583 ~ 648
							C2	648 ~ 713
		SPHWW1HDN828YHV3CC	YH	V3	VA, VB	CC	C1	583 ~ 648
							C2	648 ~ 713
	3500	SPHWW1HDN828YHU2CC	YH	U2	UB	CC	C1	601 ~ 667
							C2	667 ~ 734
		SPHWW1HDN828YHU3CC	YH	U3	UA, UB	CC	C1	601 ~ 667
							C2	667 ~ 734



b) Chromaticity Region & Coordinates ( $I_F = 180 \text{ mA}$ ,  $T_a = 25 \text{ }^\circ\text{C}$ )

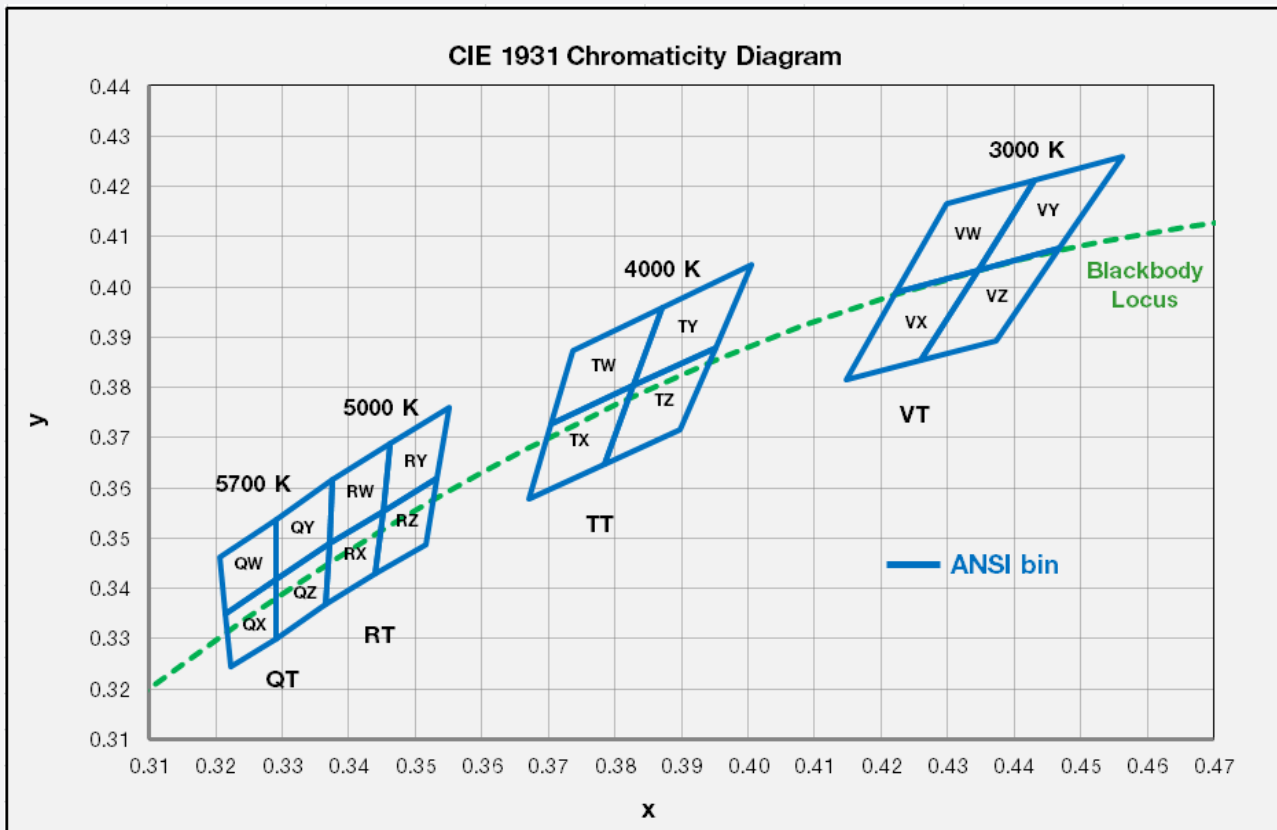

Region	CIE x	CIE y	Region	CIE x	CIE y
<b>V rank (3000 K)</b>					
VW	0.4223	0.399	VY	0.4345	0.4033
	0.4345	0.4033		0.4468	0.4077
	0.4431	0.4213		0.4562	0.4260
	0.4299	0.4165		0.4431	0.4213
VX	0.4223	0.399	VZ	0.4260	0.3854
	0.4147	0.3814		0.4373	0.3893
	0.4260	0.3854		0.4468	0.4077
	0.4345	0.4033		0.4345	0.4033
<b>R rank (5000 K)</b>					
RW	0.3376	0.3616	RY	0.3463	0.3687
	0.3463	0.3687		0.3551	0.3760
	0.3451	0.3554		0.3533	0.3620
	0.3371	0.3490		0.3451	0.3554
RX	0.3371	0.3490	RZ	0.3451	0.3554
	0.3451	0.3554		0.3533	0.3620
	0.3440	0.3428		0.3515	0.3487
	0.3366	0.3369		0.3440	0.3428

Region	CIE x	CIE y	Region	CIE x	CIE y
<b>T rank (4000 K)</b>					
TW	0.3736	0.3874	TY	0.3871	0.3959
	0.3871	0.3959		0.4006	0.4044
	0.3828	0.3803		0.3952	0.388
	0.3703	0.3726		0.3828	0.3803
TX	0.3703	0.3726	TZ	0.3828	0.3803
	0.3828	0.3803		0.3952	0.388
	0.3784	0.3647		0.3898	0.3716
	0.367	0.3578		0.3784	0.3647
<b>Q rank (5700 K)</b>					
QW	0.3207	0.3462	QY	0.3290	0.3538
	0.3290	0.3538		0.3376	0.3616
	0.3290	0.3417		0.3371	0.3490
	0.3215	0.3350		0.3290	0.3417
QX	0.3215	0.3350	QZ	0.3290	0.3417
	0.3290	0.3417		0.3371	0.3490
	0.3290	0.3300		0.3366	0.3369
	0.3222	0.3243		0.3290	0.3300

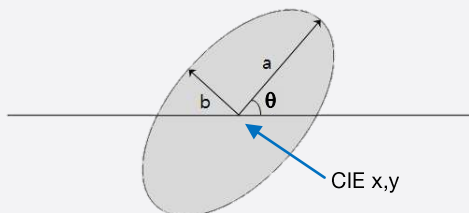
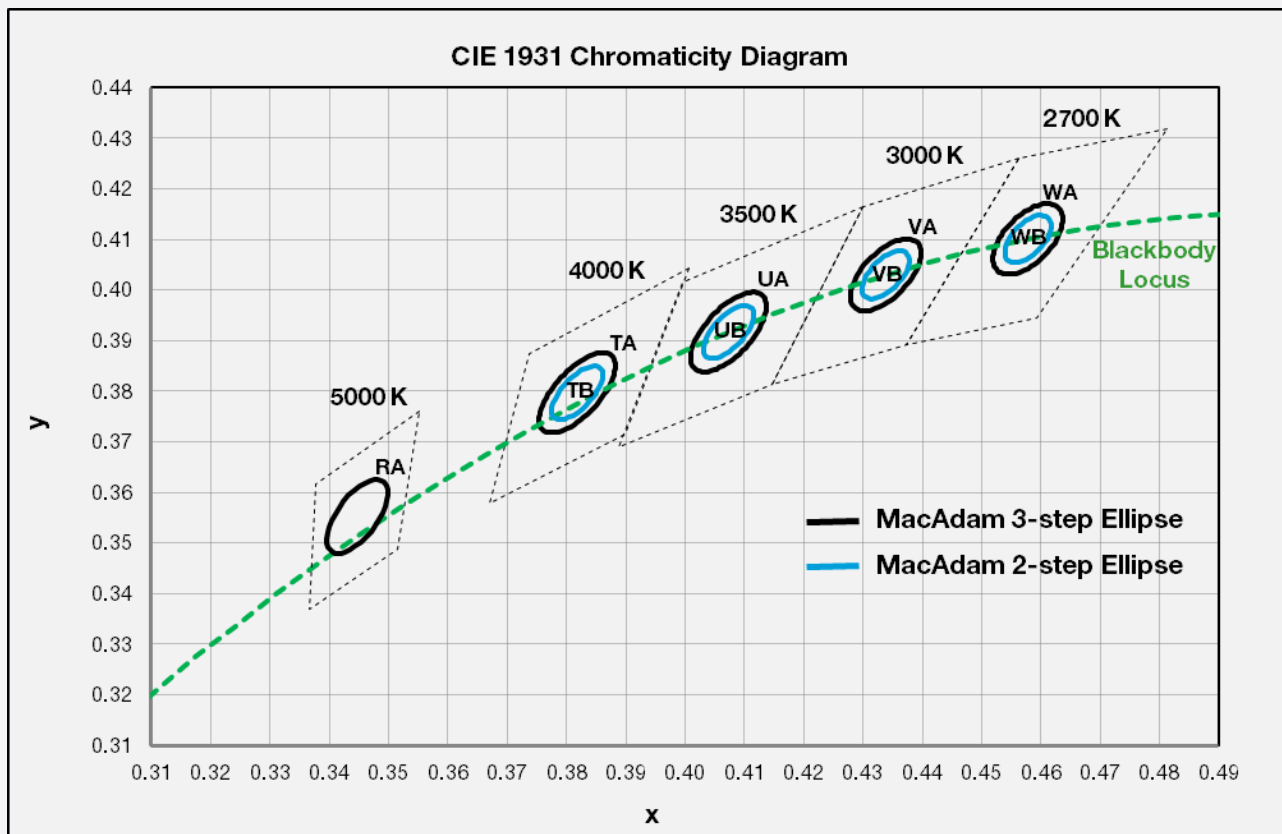
**b) Chromaticity Region & Coordinates ( $I_F = 180 \text{ mA}$ ,  $T_a = 25^\circ\text{C}$ )**

MacAdam Ellipse (WA, WB)					
Step	CIE x	CIE y	$\theta$	a	b
2-step	0.4578	0.4101	53.70	0.0054	0.0028
3-step	0.4578	0.4101	53.70	0.0081	0.0042

MacAdam Ellipse (VA, VB)					
Step	CIE x	CIE y	$\theta$	a	b
2-step	0.4338	0.403	53.22	0.0056	0.0027
3-step	0.4338	0.4030	53.22	0.0083	0.0041

MacAdam Ellipse (UA, UB)					
Step	CIE x	CIE y	$\theta$	a	b
2-step	0.4073	0.3917	54.00	0.0062	0.0028
3-step	0.4073	0.3917	54.00	0.0093	0.0041

MacAdam Ellipse (TA, TB)					
Step	CIE x	CIE y	$\theta$	a	b
2-step	0.3818	0.3797	53.72	0.0063	0.0027
3-step	0.3818	0.3797	53.72	0.0094	0.0040

MacAdam Ellipse (RA)					
Step	CIE x	CIE y	$\theta$	a	b
3-step	0.3447	0.3553	59.62	0.0082	0.0035

**Note:**

Samsung maintains measurement tolerance of:  $C_x, C_y = \pm 0.005$

### 3. Typical Characteristics Graphs

#### a) Spectrum Distribution ( $I_f = 180 \text{ mA}$ , $T_c = 25 \text{ }^\circ\text{C}$ )

CCT: 2700 K

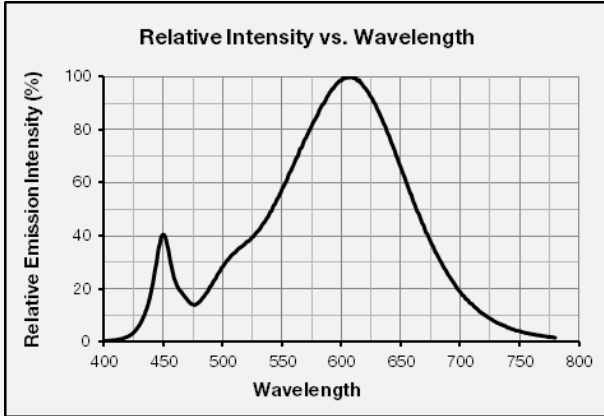

CCT: 3000 K

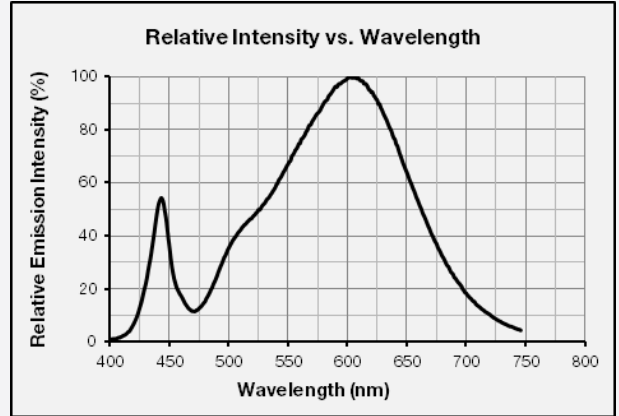

CCT: 3500 K

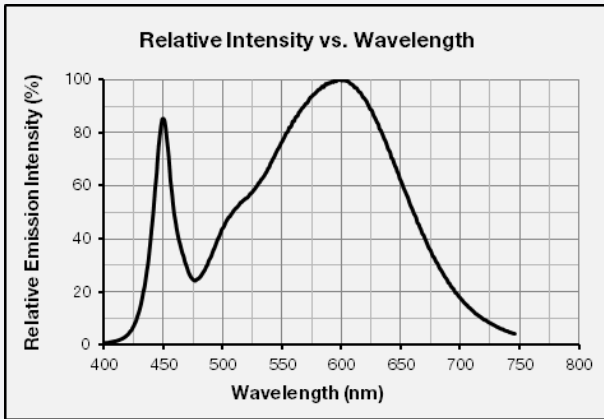

CCT: 4000 K

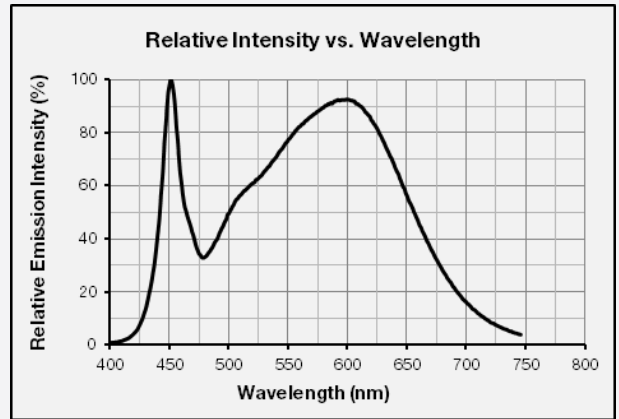

CCT: 5000 K

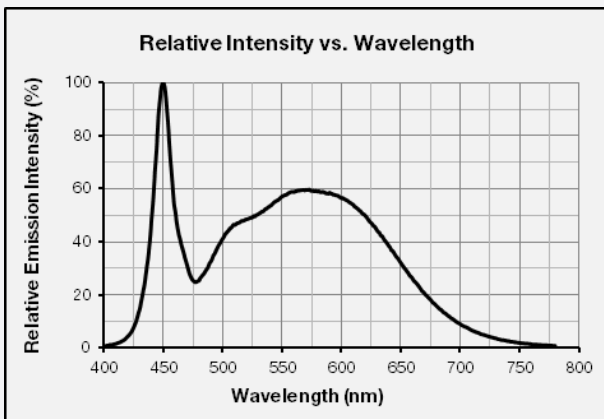

CCT: 5700 K

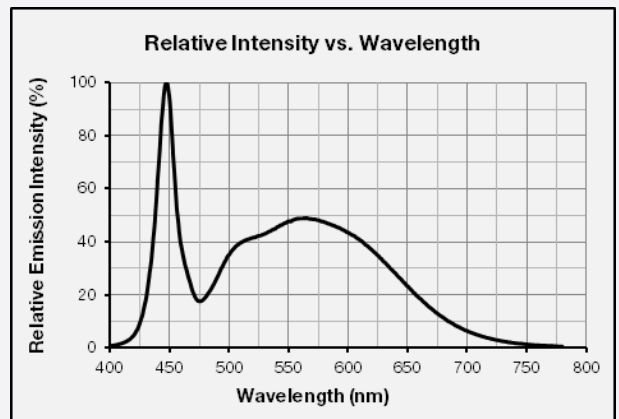

**b) Forward Current Characteristics ( $T_c = 25^\circ\text{C}$ )**

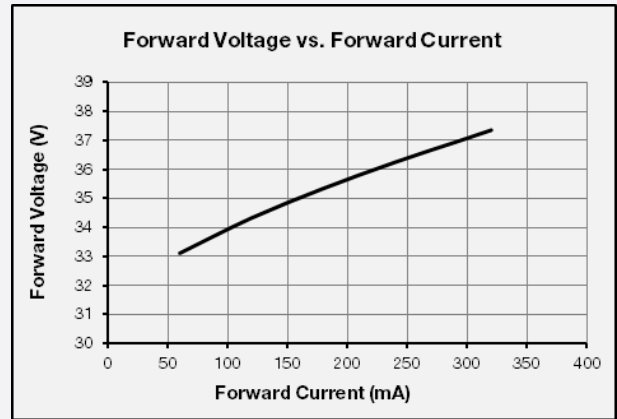
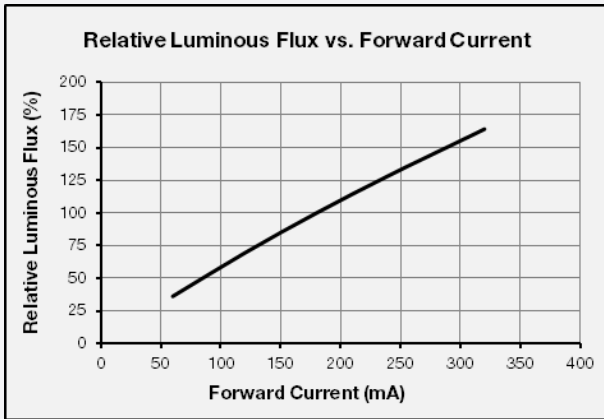

**c) Temperature Characteristics ( $I_f = 180\text{ mA}$ )**

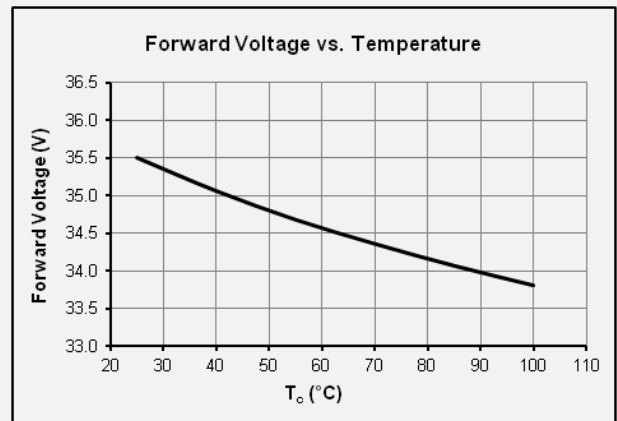
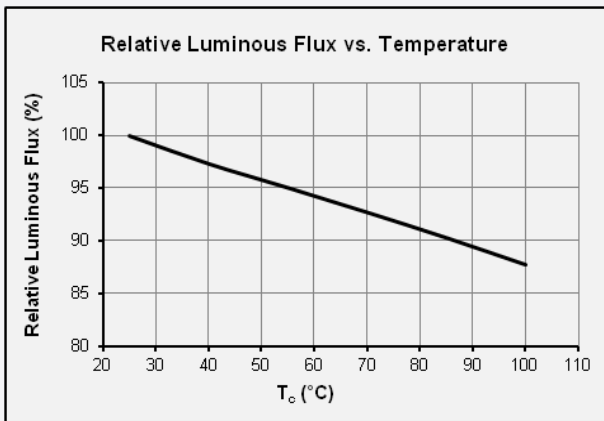

**d) Color Shift Characteristics  $T_c = 25^\circ\text{C}$**

$I_f = 180\text{ mA}$

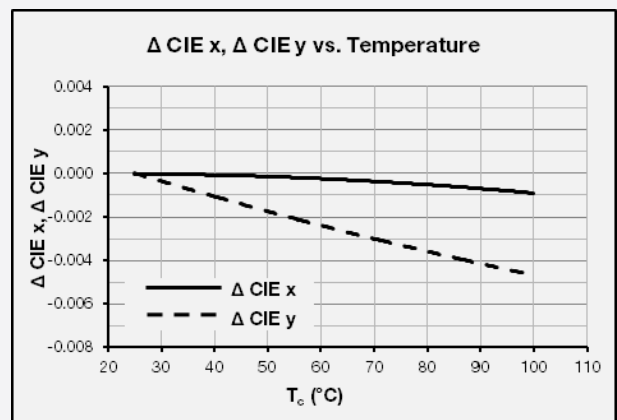
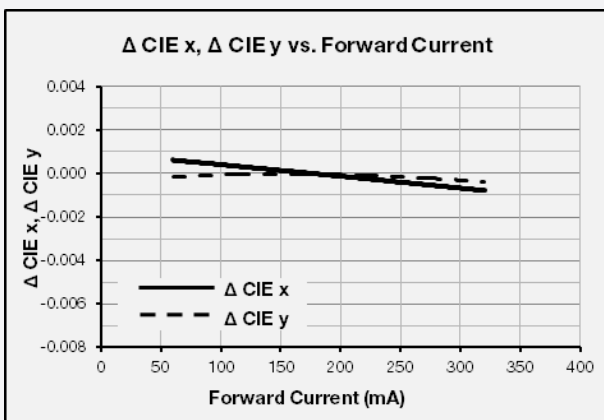

## e) Derating Curve

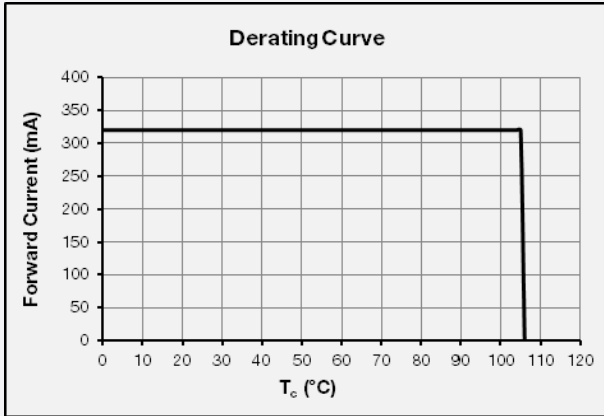
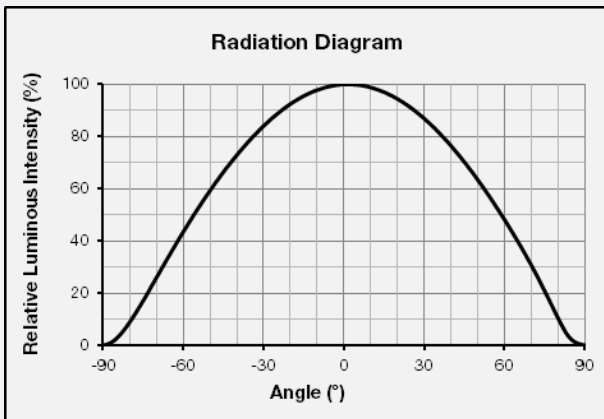
f) Beam Angle Characteristics ( $I_F = 180$  mA,  $T_c = 25$  °C)

#### 4. Outline Drawing & Dimension

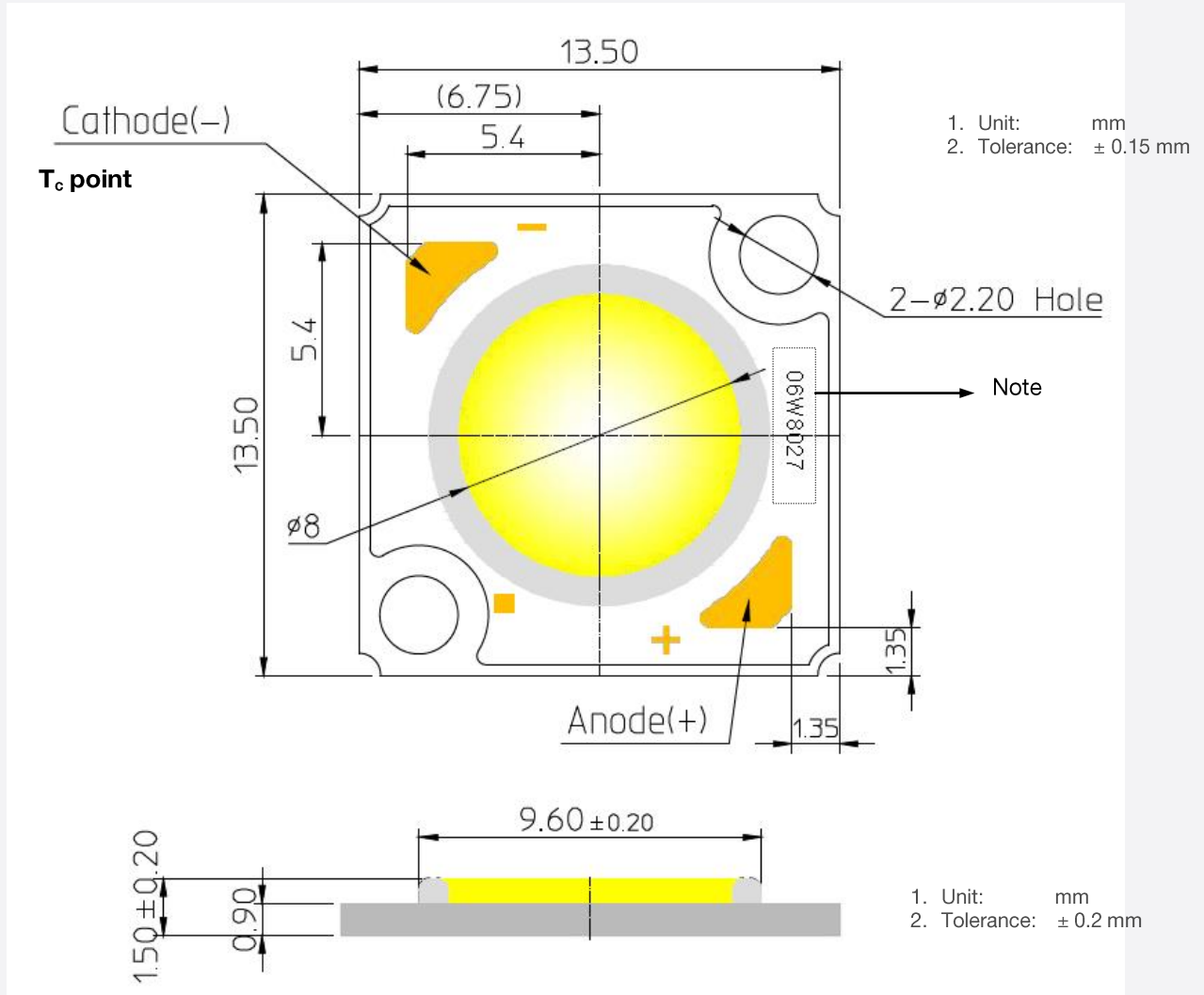

Item	Dimension	Tolerance	Unit
Length	13.50	$\pm 0.15$	mm
Width	13.50	$\pm 0.15$	mm
Height	1.50	$\pm 0.20$	mm
Light Emitting Surface (LES) Diameter	8	$\pm 0.15$	mm
Screw Hole Size	2.2	$\pm 0.15$	mm

Note: Denoted product information above is only an example  
( 06W8027 : 6.4W, CRI80+, 2700K )



## 5. Reliability Test Items & Conditions

### a) Test Items

Test Item	Test Condition	Test Hour / Cycle
Room Temperature Life Test	25 °C, $I_F = \text{max}$	1000 h
High Temperature Humidity Life Test	60 °C, 90 % RH, DC Derating, $I_F = \text{max}$	1000 h
High Temperature Life Test	105 °C, DC Derating, $I_F = \text{max}$	1000 h
Low Temperature Life Test	-40 °C, DC 320 mA	1000 h
High Temperature Storage	120 °C	1000 h
Low Temperature Storage	-40 °C	1000 h
Thermal Shock	-45 °C / 15 min ↔ 125 °C / 15 min temperature change in 5 min	200 cycles
Temperature Cycle On/Off Test	-40 °C / 85 °C each 20 min, 100 min transfer power on/off each 5 min, DC 180 mA	100 cycles
Temperature Humidity Storage Test	-10 °C ↔ 25 °C, 95 % RH ↔ 85 °C, 95 % RH (24 h / cycle)	100 cycles
ESD (HBM)	$R_1$ : 10 M $\Omega$ $R_2$ : 1.5 k $\Omega$ C: 100 pF V: $\pm 2$ kV	5 times
ESD (MM)	$R_1$ : 10 M $\Omega$ $R_2$ : 0 k $\Omega$ C: 200 pF V: $\pm 0.5$ kV	5 times
Vibration Test	20 ~ 80 Hz (displacement: 0.06 inch, max. 20 g) 80 ~ 2 kHz (max. 20 g) min. frequency ↔ max. frequency 4 min transfer	4 times
Mechanical Shock Test	1500 g, 0.5 ms each of the 6 surfaces (3 axis x 2 sides)	5 times
Salt Spray Test	35 °C, 5 % salt water 8 h spray, 16 h dwell	2 cycles

### b) Criteria for Judging the Damage

Item	Symbol	Test Condition ( $T_c = 25$ °C)	Limit	
			Min.	Max.
Forward Voltage	$V_F$	$I_F = 180$ mA	L.S.L. * 0.9	U.S.L. * 1.1
Luminous Flux	$\Phi_v$	$I_F = 180$ mA	L.S.L. * 0.7	U.S.L. * 1.3

## 6. Label Structure

### a) Label Structure

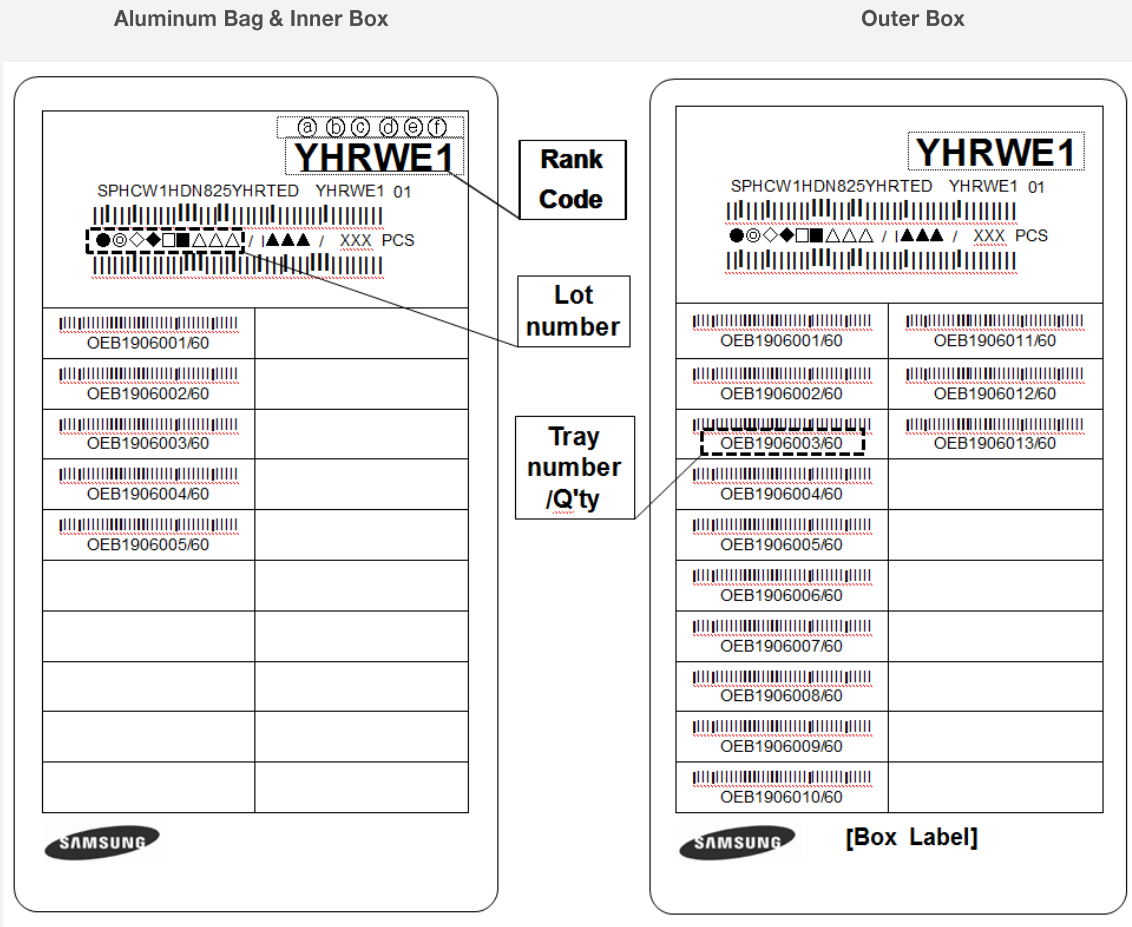

Note: Denoted rank code and product code above is only an example (see description on page 5)

Rank Code:

- ⒶⒷ: Forward Voltage rank (refer to page 6-7)
- ⒸⒹ: Chromaticity bin (refer to page 8-9)
- ⒺⒻ: Luminous Flux bin (refer to page 6-7)

## b) Lot Number

The lot number is composed of the following characters:

●◎◇◆□■△△△ / 1▲▲▲ / xxx PCS

- : Production site (S: Giheung, Korea, G: Tianjin, China)
- ◎ : L (LED)
- ◇ : Product state (A: Normal, B: Bulk, C: First Production, R: Reproduction, S: Sample)
- ◆ : Year (Y: 2014, Z: 2015, A: 2016, ...)
- : Month (1~9, A, B, C)
- : Day (1~9, A, B~V)
- △△△ : Product serial number (001 ~ 009)
- ▲▲▲ : Tray number (001 ~ 999)

## 7. Packing Structure

Packing material	Max. quantity in pcs of COB	Dimension (mm)			
		Length	Width	Height	Tolerance
Tray	144	322.6	135.9	11	0.25
Aluminum Bag	720 (5 trays)	450	230	-	10
PE Foam Pad	-	280	130	10	2
Inner Box	720 (1 aluminum bag)	338	143	55	2
Outer Box	2880 (4 inner boxes)	346	303	120	5
Pallet	161,280 (56 outer boxes)	1000	1000	970	10

### a) Packing Structure for 5 trays inside Aluminum Bag

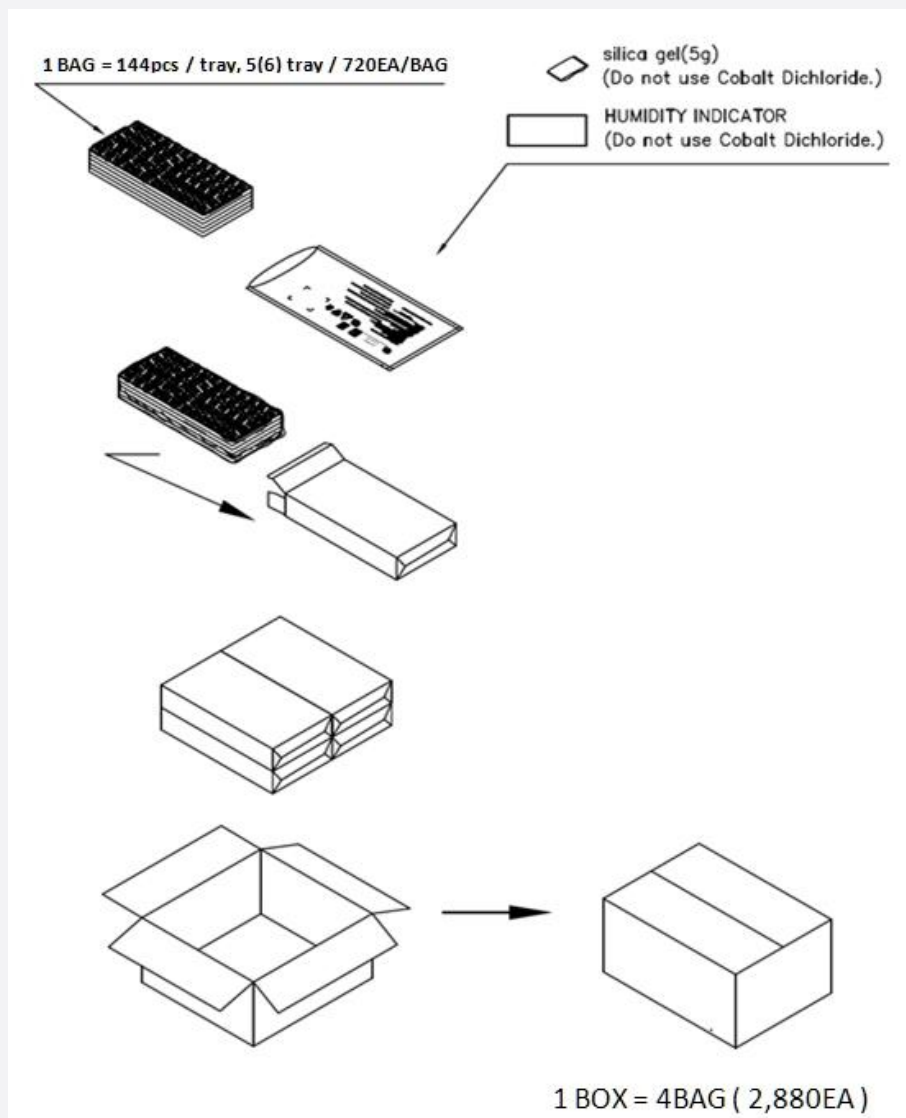



d) Aluminum Vinyl Packing Bag

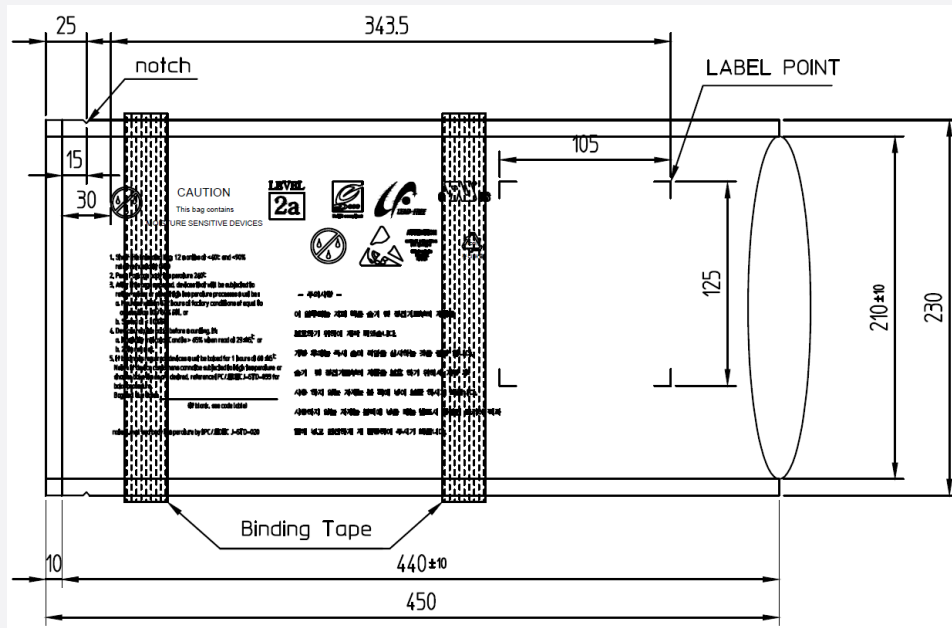

e) Silica Gel & Humidity Indicator Card inside Aluminum Vinyl Packing Bag

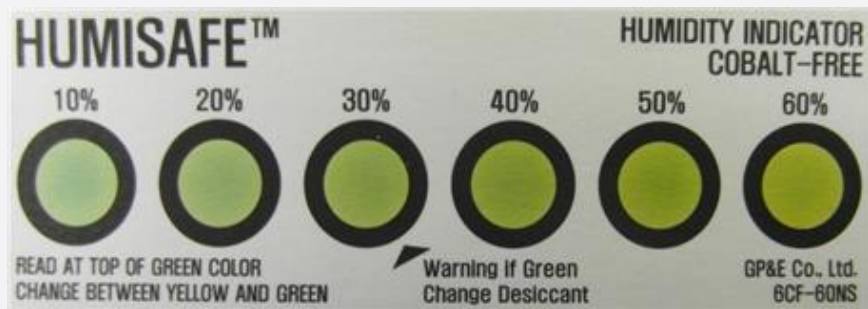



## 8. Precautions in Handling & Use

- 1) This device should not be used in any type of fluid such as water, oil, organic solvent, etc. When cleaning is required, IPA is recommended as the cleaning agent. Some solvent-based cleaning agent may damage the silicone resins used in the device.
- 2) LEDs must be stored in a clean environment. If the LEDs are to be stored for three months or more after being shipped from Samsung, they should be packed with a nitrogen-filled container (shelf life of sealed bags is 12 months at temperature 0~40 °C, 0~90 % RH).
- 3) After storage bag is opened, device subjected to soldering, solder reflow, or other high temperature processes must be:
  - a. Mounted within 672 hours (28 days) at an assembly line with a condition of no more than 30 °C / 60 % RH, or
  - b. Stored at <10 % RH
- 4) Repack unused products with anti-moisture packing, fold to close any opening and then store in a dry place.
- 5) Devices require baking before mounting, if humidity card reading is >60 % at 23 ± 5 °C.
- 6) Devices must be baked for 1 hour at 60 ± 5 °C, if baking is required.
- 7) The LEDs are sensitive to the static electricity and surge current. It is recommended to use a wrist band or anti-electrostatic glove when handling the LEDs. If voltage exceeding the absolute maximum rating is applied to LEDs, it may cause damage or even destruction to LED devices. Damaged LEDs may show some unusual characteristics such as increase in leakage current, lowered turn-on voltage, or abnormal lighting of LEDs at low current.
- 8) VOCs (Volatile Organic Compounds) can be generated from adhesives, flux, hardener or organic additives used in luminaires (fixtures). Transparent LED silicone encapsulant is permeable to those chemicals and they may lead to a discoloration of encapsulant when they exposed to heat or light. This phenomenon can cause a significant loss of light emitted (output) from the luminaires. In order to prevent these problems, we recommend users to know the physical properties of materials used in luminaires and they must be carefully selected.
- 9) The resin area is very sensitive, please do not handle, press, touch, rub, clean, or pick by with tweezers on it. Instead, please pick at the handling area as indicated below.

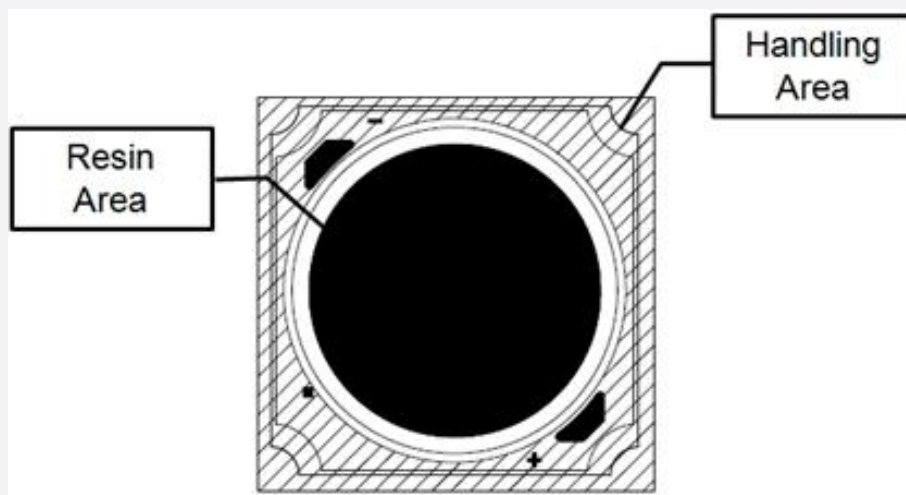

# Legal and additional information.

## [About Samsung Electronics Co., Ltd.](#)

Samsung Electronics Co., Ltd. inspires the world and shapes the future with transformative ideas and technologies, redefining the worlds of TVs, smartphones, wearable devices, tablets, cameras, digital appliances, printers, medical equipment, network systems and semiconductors.

We are also leading in the Internet of Things space through, among others, our Digital Health and Smart Home initiatives. We employ 307,000 people across 84 countries. To discover more, please visit our official website at [www.samsung.com](http://www.samsung.com) and our official blog at [global.samsungtomorrow.com](http://global.samsungtomorrow.com).

Copyright © 2015 Samsung Electronics Co., Ltd. All rights reserved.

Samsung is a registered trademark of Samsung Electronics Co., Ltd.

Specifications and designs are subject to change without notice. Non-metric weights and measurements are approximate. All data were deemed correct at time of creation. Samsung is not liable for errors or omissions. All brand, product, service names and logos are trademarks and/or registered trademarks of their respective owners and are hereby recognized and acknowledged.

Samsung Electronics Co., Ltd.

95, Samsung 2-ro

Giheung-gu

Yongin-si, Gyeonggi-do, 446-711

KOREA

[www.samsungled.com](http://www.samsungled.com)

