



Chipsmall Limited consists of a professional team with an average of over 10 year of expertise in the distribution of electronic components. Based in Hongkong, we have already established firm and mutual-benefit business relationships with customers from,Europe,America and south Asia,supplying obsolete and hard-to-find components to meet their specific needs.

With the principle of “Quality Parts,Customers Priority,Honest Operation,and Considerate Service”,our business mainly focus on the distribution of electronic components. Line cards we deal with include Microchip,ALPS,ROHM,Xilinx,Pulse,ON,Everlight and Freescale. Main products comprise IC,Modules,Potentiometer,IC Socket,Relay,Connector.Our parts cover such applications as commercial,industrial, and automotives areas.

We are looking forward to setting up business relationship with you and hope to provide you with the best service and solution. Let us make a better world for our industry!



## Contact us

Tel: +86-755-8981 8866 Fax: +86-755-8427 6832

Email & Skype: info@chipsmall.com Web: www.chipsmall.com

Address: A1208, Overseas Decoration Building, #122 Zhenhua RD., Futian, Shenzhen, China



## High Power LED Series Chip on Board

# LC008B



High efficacy COB LED package,  
well-suited for use in spotlight applications

### Features & Benefits

- Chip on Board (COB) solution makes it easy to design in
- Simple assembly reduces manufacturing cost
- Low thermal resistance
- InGaN/GaN MQW LED with long time reliability
- Completed 6,000 hours of LM-80 Testing
- ENEC certified: Integral LED Module

### Applications

- Spotlight / Downlight
- LED Retrofit Bulbs
- Outdoor Illumination



## Table of Contents

1.	Characteristics	-----	3
2.	Product Code Information	-----	6
3.	Typical Characteristics Graphs	-----	12
4.	Outline Drawing & Dimension	-----	15
5.	Reliability Test Items & Conditions	-----	16
6.	Label Structure	-----	17
7.	Packing Structure	-----	19
8.	Precautions in Handling & Use	-----	22

## 1. Characteristics

### a) Absolute Maximum Rating

Item	Symbol	Rating	Unit	Condition
Ambient / Operating Temperature	$T_a$	-40 ~ +105	°C	-
Storage Temperature	$T_{stg}$	-40 ~ +120	°C	-
LED Junction Temperature	$T_j$	140	°C	-
Case Temperature	$T_c$	105	°C	*Note
Forward Current	$I_F$	430	mA	-
Power Dissipation	$P_D$	15.8	W	-
ESD (HBM)	-	±2	kV	-
ESD (MM)	-	±0.5	kV	-

### b) Electro-optical Characteristics ( $I_F = 240 \text{ mA}$ , $T_a = 25 \text{ °C}$ )

Item	Unit	Rank	Min.	Typ.	Max.
Forward Voltage ( $V_f$ )	V	YH	33.5	36.5	39.5
Color Rendering Index ( $R_a$ )	-	3	70	-	-
		5	80	-	-
		7	90	-	-
		8	95	-	-
Thermal Resistance (junction to chip point)	°C/W		-	2.0	-
Beam Angle	°		-	115	-
Working Voltage for Insulation	V				50
Nominal Power	W			8.8	
Eye Protection		Risk 1	-		-

#### Notes:

- 1) The COB is tested in pulsed condition at rated test current (10 ms pulse width) and rated temperature ( $T_j = T_c = T_a = 25 \text{ °C}$ )
- 2) Samsung maintains measurement tolerance of: forward voltage = ±5 %, CRI = ±1
- 3) Max  $T_c=105\text{°C}$  (at max current) is for ENEC condition. Refer to the derating curve, '3. Typical Characteristics Graph' designed within the range.

c) Luminous Flux Characteristics ( $I_F = 240 \text{ mA}$ ,  $T_a = 25 \text{ }^\circ\text{C}$ )

CRI ( $R_a$ ) Min.	Nominal CCT (K)	Flux Rank	Flux Bin	Sorting <sup>1)</sup> @ $T_c = 25 \text{ }^\circ\text{C}$ (lm)		Calculated Flux <sup>2)</sup> @ $T_c = 85 \text{ }^\circ\text{C}$ (lm)		
				Min.	Max.	Min.	Max.	
70	3000	MG	M1	1064	1209	958	1088	
			M2	1209	1354	1088	1219	
	4000	MG	M1	1117	1270	1006	1143	
			M2	1270	1422	1143	1280	
	5000	MG	M1	1128	1282	1015	1154	
			M2	1282	1436	1154	1292	
	80	2700	KE	K2	968	1041	881	947
				K3	1041	1114	947	1014
K4				1114	1187	1014	1080	
KG			K3	1041	1114	947	1014	
		K4	1114	1187	1014	1080		
3000		KE	K2	1030	1108	937	1008	
			K3	1108	1185	1008	1078	
			K4	1185	1263	1078	1149	
		KG	K3	1108	1185	1008	1078	
K4			1185	1263	1078	1149		
3500		KE	K2	1061	1141	965	1038	
			K3	1141	1221	1038	1111	
			K4	1221	1300	1111	1183	
		KG	K3	1141	1221	1038	1111	
K4			1221	1300	1111	1183		
4000		KE	K2	1092	1174	994	1068	
	K3		1174	1256	1068	1143		
	K4		1256	1338	1143	1218		
	KG	K3	1174	1256	1068	1143		
K4		1256	1338	1143	1218			
5000	KE	K2	1102	1185	1003	1078		
		K3	1185	1268	1078	1154		
		K4	1268	1351	1154	1229		
	KG	K3	1185	1268	1078	1154		
K4		1268	1351	1154	1229			
5700	KE	K2	1102	1185	1003	1078		
		K3	1185	1268	1078	1154		
		K4	1268	1351	1154	1229		
	KG	K3	1185	1268	1078	1154		
K4		1268	1351	1154	1229			

**c) Luminous Flux Characteristics (I<sub>F</sub> = 240 mA, T<sub>a</sub> = 25 °C)**

CRI (R <sub>a</sub> ) Min.	Nominal CCT (K)	Flux Rank	Flux Bin	Sorting <sup>1)</sup> @ T <sub>c</sub> = 25 °C (lm)		Calculated Flux <sup>2)</sup> @ T <sub>c</sub> = 85 °C (lm)	
				Min.	Max.	Min.	Max.
90	2700	FG	F2	859	933	781	849
			F3	933	1008	849	917
			F4	1008	1083	917	985
	3000	FG	F2	876	952	797	867
			F3	952	1029	867	936
			F4	1029	1105	936	1005
	3500	FG	F2	903	981	821	893
			F3	981	1060	893	964
			F4	1060	1138	964	1036
	4000	FG	F2	929	1010	845	919
			F3	1010	1090	919	992
			F4	1090	1171	992	1066
95	2700	EC	E1	756	840	688	764
			E2	840	924	764	841
	3000	EC	E1	779	866	709	788
			E2	866	953	788	867
	3500	EC	E1	803	892	731	812
			E2	892	981	812	893

**Notes:**

- 1) The COB is tested in pulsed condition at rated test current (10 ms pulse width) and rated temperature (T<sub>j</sub> = T<sub>c</sub> = T<sub>a</sub> = 25 °C)
- 2) Calculated flux values are for reference only
- 3) Samsung maintains measurement tolerance of: luminous flux = ±7 %, CRI = ±1

## 2. Product Code Information

1	2	3	4	5	6	7	8	9	10	11	12	13	14	15	16	17	18
S	P	H	C	W	1	H	D	N	9	4	5	Y	H	R	T	K	E

Digit	PKG Information	Code	Specification
1 2 3	Samsung Package High Power	<b>SPH</b>	
4 5	Color	<b>WW</b> <b>CW</b>	Warm White (T/U/V/W Ranks) Cool White (Q/R Ranks)
6	Product Version	<b>1</b>	
7 8	Form Factor	<b>HD</b>	COB
9	Lens Type	<b>N</b>	No lens
10	Internal Code	<b>9</b>	LC008
11	Chip Type	<b>4</b>	
12	CRI & Sorting Temperature	<b>3</b> <b>5</b> <b>7</b> <b>8</b>	Min. 70 Min. 80 25 °C Min. 90 Min 95
13 14	Forward Voltage (V)	<b>YH</b>	33.5~39.5
15	CCT (K)	<b>W</b> <b>V</b> <b>U</b> <b>T</b> <b>R</b> <b>Q</b>	2700 K WA, WB (MacAdam Ellipse) 3000 K VA, VB (MacAdam Ellipse) VW, VX, VY, VZ (ANSI bin) 3500 K UA, UB (MacAdam Ellipse) 4000 K TA, TB (MacAdam Ellipse) TW, TX, TY, TZ (ANSI bin) 5000 K RA (MacAdam Ellipse) RW, RX, RY, RZ (ANSI bin) 5700 K QW, QX, QY, QZ (ANSI bin)
16	MacAdam / ANSI	<b>2</b> <b>3</b> <b>T</b>	MacAdam 2-step MacAdam 3-step ANSI bin
17 18	Luminous Flux	<b>MG</b> <b>KE</b> <b>KG</b> <b>FG</b> <b>EC</b>	M1, M2 (70 CRI) K2, K3, K4 (80 CRI) Bin Code: K3, K4 (80 CRI) F2, F3, F4 (90 CRI) E1, E2 (95 CRI)

a) Binning Structure ( $I_F = 240 \text{ mA}$ ,  $T_a = 25 \text{ }^\circ\text{C}$ )

CRI (R <sub>a</sub> ) Min.	Nominal CCT (K)	Product Code	V <sub>f</sub> Rank	Color Rank	Chrom. Bin	Flux Rank	Flux Bin	Flux Range (Φ <sub>v</sub> , lm)	
70	3000	SPHWW1HDN943YHVTMG	YH	VT	VV, VX VY, VZ	MG	M1	1064 ~ 1209	
							M2	1209 ~ 1354	
	4000	SPHWW1HDN943YHTTMG	YH	TT	TW, TX TY, TZ	MG	M1	1117 ~ 1270	
							M2	1270 ~ 1422	
	5000	SPHCW1HDN943YHRTMG	YH	RT	RW, RX RY, RZ	MG	M1	1128 ~ 1282	
							M2	1282 ~ 1436	
80	2700	SPHWW1HDN945YHW2KE	YH	W2	WB	KE	K2	968 ~ 1041	
							K3	1041 ~ 1114	
							K4	1114 ~ 1187	
		SPHWW1HDN945YHW3KE	YH	W3	WA, WB	KE	KE	K2	968 ~ 1041
								K3	1041 ~ 1114
								K4	1114 ~ 1187
		SPHWW1HDN945YHW2KG	YH	W2	WB	KG	KG	K3	1041 ~ 1114
								K4	1114 ~ 1187
								K3	1041 ~ 1114
		SPHWW1HDN945YHW3KG	YH	W3	WA, WB	KG	KG	K4	1114 ~ 1187
								K2	1030 ~ 1108
								K3	1108 ~ 1185
	3000	SPHWW1HDN945YHV2KE	YH	V2	VB	KE	KE	K4	1185 ~ 1263
								K2	1030 ~ 1108
								K3	1108 ~ 1185
		SPHWW1HDN945YHV3KE	YH	V3	VA, VB	KE	KE	K4	1185 ~ 1263
								K3	1108 ~ 1185
								K4	1185 ~ 1263
		SPHWW1HDN945YHV2KG	YH	V2	VB	KG	KG	K3	1108 ~ 1185
								K4	1185 ~ 1263
								K3	1108 ~ 1185
		SPHWW1HDN945YHV3KG	YH	V3	VA, VB	KG	KG	K4	1185 ~ 1263
								K2	1061 ~ 1141
								K3	1141 ~ 1221
3500	SPHWW1HDN945YHU2KE	YH	U2	UB	KE	KE	K4	1221 ~ 1300	
							K2	1061 ~ 1141	
							K3	1141 ~ 1221	
	SPHWW1HDN945YHU3KE	YH	U3	UA, UB	KE	KE	K4	1221 ~ 1300	
							K3	1141 ~ 1221	
							K4	1221 ~ 1300	
SPHWW1HDN945YHU2KG	YH	U2	UB	KG	KG	K3	1141 ~ 1221		
						K4	1221 ~ 1300		
						K3	1141 ~ 1221		
SPHWW1HDN945YHU3KG	YH	U3	UA, UB	KG	KG	K4	1221 ~ 1300		



a) Binning Structure ( $I_F = 240 \text{ mA}$ ,  $T_a = 25 \text{ }^\circ\text{C}$ )

CRI (R <sub>a</sub> ) Min.	Nominal CCT (K)	Product Code	V <sub>F</sub> Rank	Color Rank	Chrom. Bin	Flux Rank	Flux Bin	Flux Range (Φ <sub>v</sub> , lm)
80	4000	SPHWW1HDN945YHT2KE	YH	T2	TB	KE	K2	1092 ~ 1174
							K3	1174 ~ 1256
							K4	1256 ~ 1338
		SPHWW1HDN945YHT3KE	YH	T3	TA, TB	KE	K2	1092 ~ 1174
							K3	1174 ~ 1256
							K4	1256 ~ 1338
	SPHWW1HDN945YHT2KG	YH	T2	TB	KG	K3	1174 ~ 1256	
						K4	1256 ~ 1338	
						K3	1174 ~ 1256	
	5000	SPHWW1HDN945YHT3KG	YH	T3	TA, TB	KG	K4	1256 ~ 1338
							K3	1174 ~ 1256
							K2	1102 ~ 1185
SPHCW1HDN945YHR3KE		YH	R3	RA	KE	K3	1185 ~ 1268	
						K4	1268 ~ 1351	
						K2	1102 ~ 1185	
SPHCW1HDN945YHRTKE	YH	RT	RW, RX, RY, RZ	KE	K3	1185 ~ 1268		
					K4	1268 ~ 1351		
					K3	1185 ~ 1268		
5700	SPHWW1HDN945YHR3KG	YH	R3	RA	KG	K4	1268 ~ 1351	
						K3	1185 ~ 1268	
						K2	1102 ~ 1185	
	SPHWW1HDN945YHRTKG	YH	RT	RW, RX, RY, RZ	KG	K3	1185 ~ 1268	
						K4	1268 ~ 1351	
						K2	1102 ~ 1185	
SPHCW1HDN945YHQTKG	YH	QT	QW, QX, QY, QZ	KE	K3	1185 ~ 1268		
					K4	1268 ~ 1351		
					K3	1185 ~ 1268		
SPHWW1HDN945YHQTKG	YH	QT	QW, QX, QY, QZ	KG	K4	1268 ~ 1351		
					K3	1185 ~ 1268		
					K4	1268 ~ 1351		

a) Binning Structure ( $I_F = 240 \text{ mA}$ ,  $T_a = 25 \text{ }^\circ\text{C}$ )

CRI (R <sub>a</sub> ) Min.	Nominal CCT (K)	Product Code	V <sub>f</sub> Rank	Color Rank	Chrom. Bin	Flux Rank	Flux Bin	Flux Range (Φ <sub>v</sub> , lm)
90	2700	SPHWW1HDN947YHW2FG	YH	W2	WB	FG	F2	859 ~ 933
							F3	933 ~ 1008
							F4	1008 ~ 1083
		SPHWW1HDN947YHW3FG	YH	W3	WA, WB	FG	F2	859 ~ 933
							F3	933 ~ 1008
							F4	1008 ~ 1083
	3000	SPHWW1HDN947YHV2FG	YH	V2	VB	FG	F2	876 ~ 952
							F3	952 ~ 1029
							F4	1029 ~ 1105
		SPHWW1HDN947YHV3FG	YH	V3	VA, VB	FG	F2	876 ~ 952
							F3	952 ~ 1029
							F4	1029 ~ 1105
	3500	SPHWW1HDN947YHU2FG	YH	U2	UB	FG	F2	903 ~ 981
							F3	981 ~ 1060
							F4	1060 ~ 1138
		SPHWW1HDN947YHU3FG	YH	U3	UA, UB	FG	F2	903 ~ 981
							F3	981 ~ 1060
							F4	1060 ~ 1138
	4000	SPHWW1HDN947YHT2FG	YH	T2	TB	FG	F2	929 ~ 1010
							F3	1010 ~ 1090
							F4	1090 ~ 1171
		SPHWW1HDN947YHT3FG	YH	T3	TA, TB	FG	F2	929 ~ 1010
							F3	1010 ~ 1090
							F4	1090 ~ 1171
95	2700	SPHWW1HDN948YHW2EC	YH	W2	WB	EC	E1	756 ~ 840
							E2	840 ~ 924
		SPHWW1HDN948YHW3EC	YH	W3	WA, WB	EC	E1	756 ~ 840
							E2	840 ~ 924
	3000	SPHWW1HDN948YHV2EC	YH	V2	VB	EC	E1	779 ~ 866
							E2	866 ~ 953
		SPHWW1HDN948YHV3EC	YH	V3	VA, VB	EC	E1	779 ~ 866
							E2	866 ~ 953
	3500	SPHWW1HDN948YHU2EC	YH	U2	UB	EC	E1	803 ~ 892
							E2	892 ~ 981
		SPHWW1HDN948YHU3EC	YH	U3	UA, UB	EC	E1	803 ~ 892
							E2	892 ~ 981

b) Chromaticity Region & Coordinates ( $I_F = 240 \text{ mA}$ ,  $T_a = 25^\circ\text{C}$ )

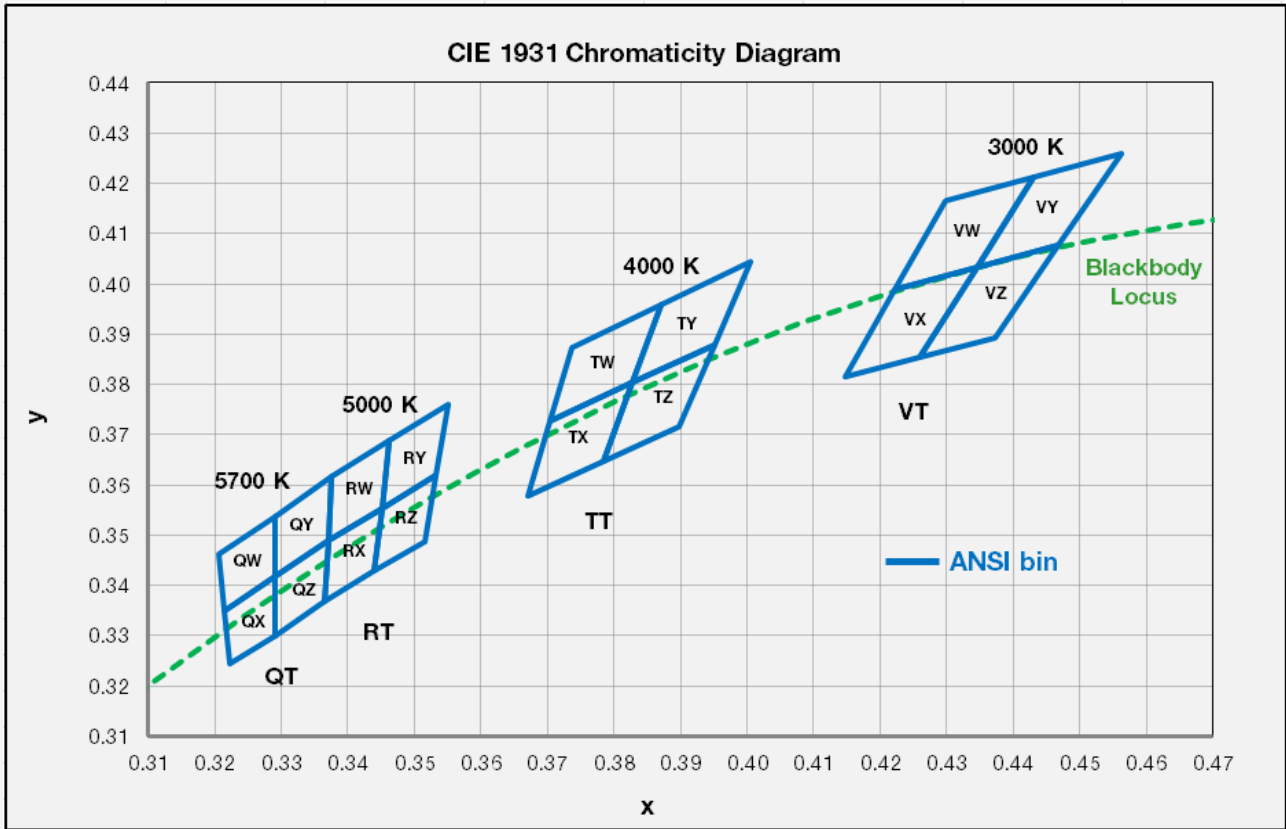

Region	CIE x	CIE y	Region	CIE x	CIE y
<b>V rank (3000 K)</b>					
VW	0.4223	0.399	VY	0.4345	0.4033
	0.4345	0.4033		0.4468	0.4077
	0.4431	0.4213		0.4562	0.4260
	0.4299	0.4165		0.4431	0.4213
VX	0.4223	0.399	VZ	0.4260	0.3854
	0.4147	0.3814		0.4373	0.3893
	0.4260	0.3854		0.4468	0.4077
	0.4345	0.4033		0.4345	0.4033
<b>R rank (5000 K)</b>					
RW	0.3376	0.3616	RY	0.3463	0.3687
	0.3463	0.3687		0.3551	0.3760
	0.3451	0.3554		0.3533	0.3620
	0.3371	0.3490		0.3451	0.3554
RX	0.3371	0.3490	RZ	0.3451	0.3554
	0.3451	0.3554		0.3533	0.3620
	0.3440	0.3428		0.3515	0.3487
	0.3366	0.3369		0.3440	0.3428

Region	CIE x	CIE y	Region	CIE x	CIE y
<b>T rank (4000 K)</b>					
TW	0.3736	0.3874	TY	0.3871	0.3959
	0.3871	0.3959		0.4006	0.4044
	0.3828	0.3803		0.3952	0.388
	0.3703	0.3726		0.3828	0.3803
TX	0.3703	0.3726	TZ	0.3828	0.3803
	0.3828	0.3803		0.3952	0.388
	0.3784	0.3647		0.3898	0.3716
	0.367	0.3578		0.3784	0.3647
<b>Q rank (5700 K)</b>					
QW	0.3207	0.3462	QY	0.3290	0.3538
	0.3290	0.3538		0.3376	0.3616
	0.3290	0.3417		0.3371	0.3490
	0.3215	0.3350		0.3290	0.3417
QX	0.3215	0.3350	QZ	0.3290	0.3417
	0.3290	0.3417		0.3371	0.3490
	0.3290	0.3300		0.3366	0.3369
	0.3222	0.3243		0.3290	0.3300

b) Chromaticity Region & Coordinates ( $I_F = 240 \text{ mA}$ ,  $T_a = 25 \text{ }^\circ\text{C}$ )

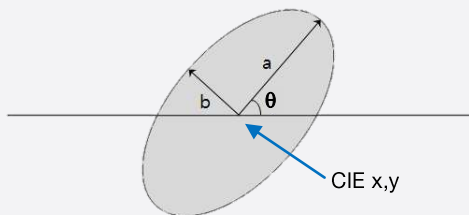
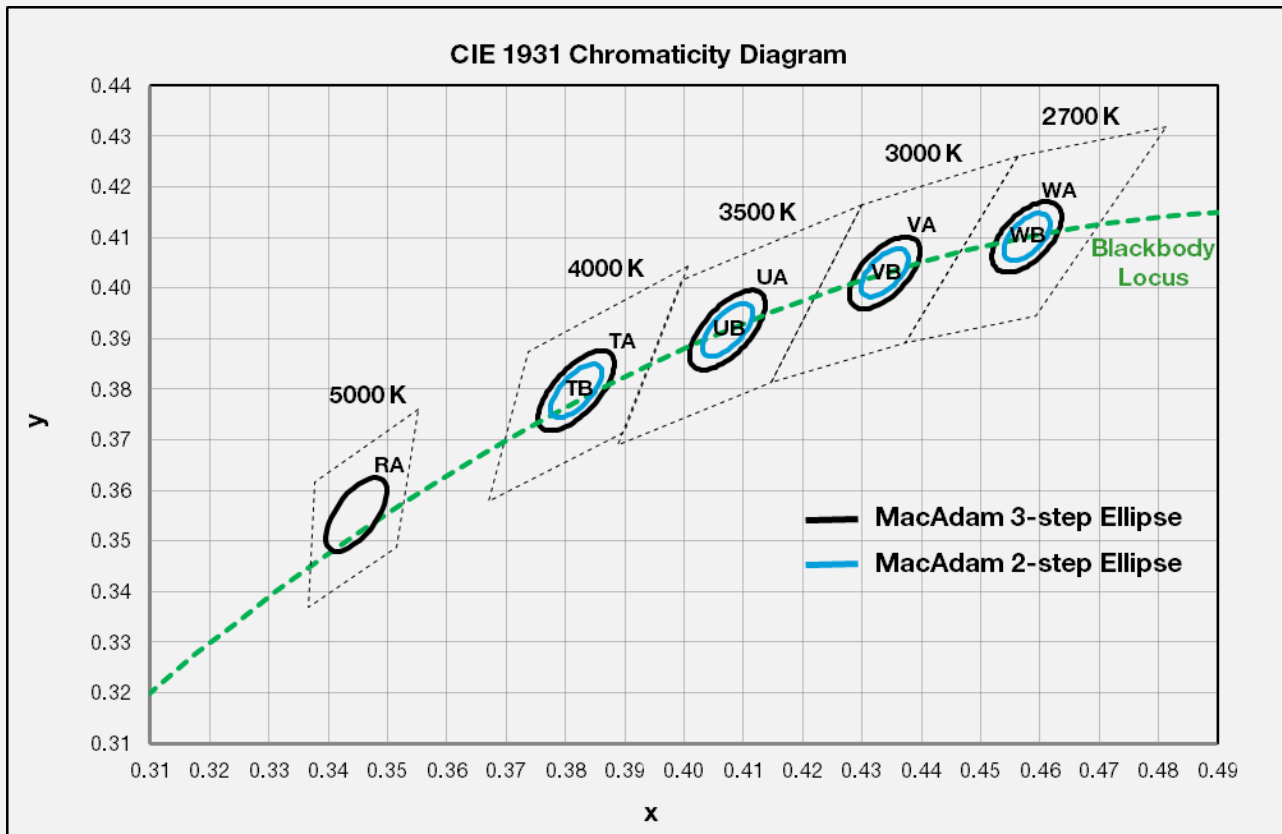

MacAdam Ellipse (WA, WB)					
Step	CIE x	CIE y	$\theta$	a	b
2-step	0.4578	0.4101	53.70	0.0054	0.0028
3-step	0.4578	0.4101	53.70	0.0081	0.0042

MacAdam Ellipse (VA, VB)					
Step	CIE x	CIE y	$\theta$	a	b
2-step	0.4338	0.403	53.22	0.0056	0.0027
3-step	0.4338	0.4030	53.22	0.0083	0.0041

MacAdam Ellipse (UA, UB)					
Step	CIE x	CIE y	$\theta$	a	b
2-step	0.4073	0.3917	54.00	0.0062	0.0028
3-step	0.4073	0.3917	54.00	0.0093	0.0041

MacAdam Ellipse (TA, TB)					
Step	CIE x	CIE y	$\theta$	a	b
2-step	0.3818	0.3797	53.72	0.0063	0.0027
3-step	0.3818	0.3797	53.72	0.0094	0.0040

MacAdam Ellipse (RA)					
Step	CIE x	CIE y	$\theta$	a	b
3-step	0.3447	0.3553	59.62	0.0082	0.0035

**Note:**

Samsung maintains measurement tolerance of:  $C_x, C_y = \pm 0.005$



### 3. Typical Characteristics Graphs

#### a) Spectrum Distribution ( $I_f = 240 \text{ mA}$ , $T_a = 25 \text{ }^\circ\text{C}$ )

CCT: 2700 K

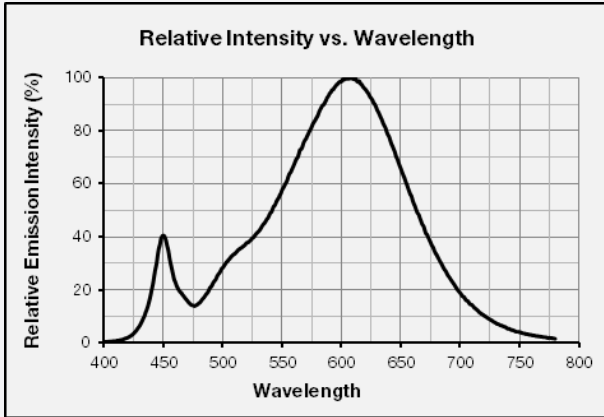

CCT: 3000 K

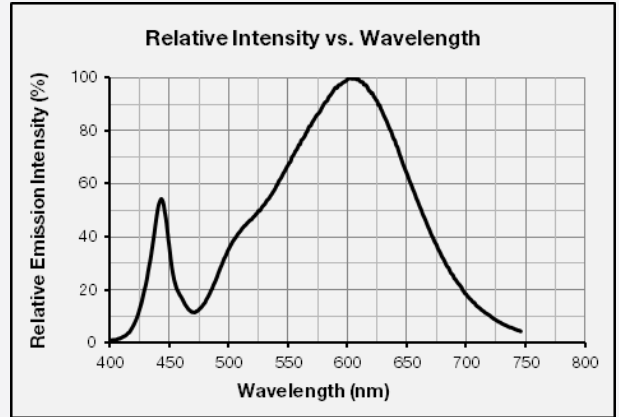

CCT: 3500 K

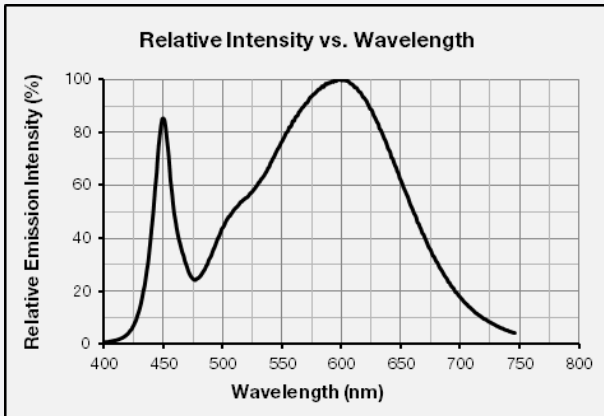

CCT: 4000 K

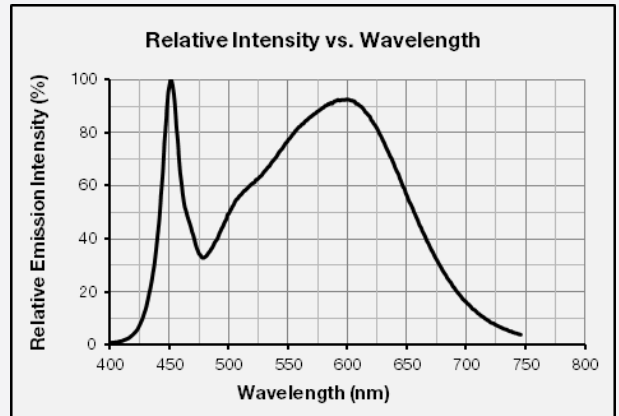

CCT: 5000 K

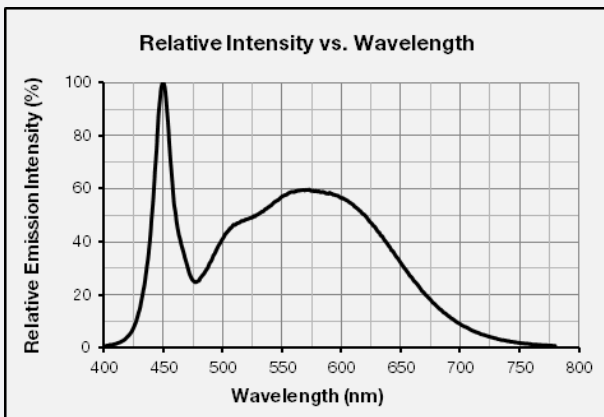

CCT: 5700 K

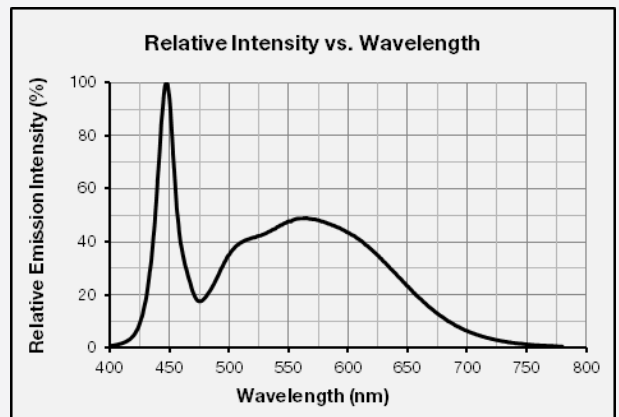

**b) Forward Current Characteristics ( $T_a = 25\text{ }^\circ\text{C}$ )**

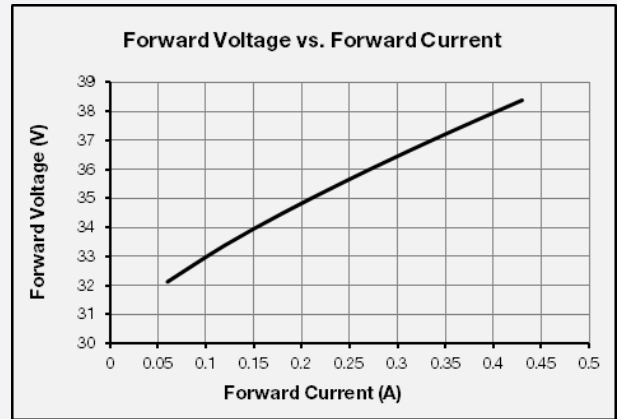
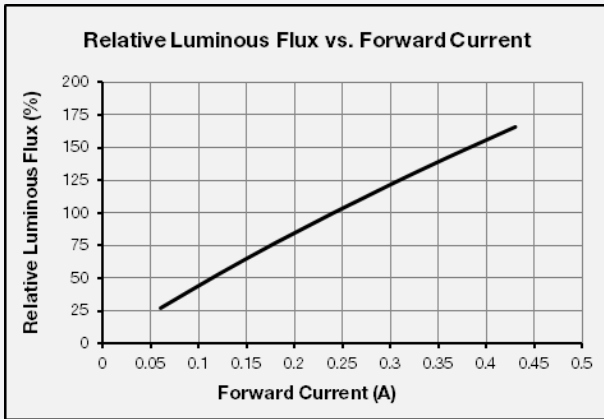

**c) Temperature Characteristics ( $I_f = 240\text{ mA}$ )**

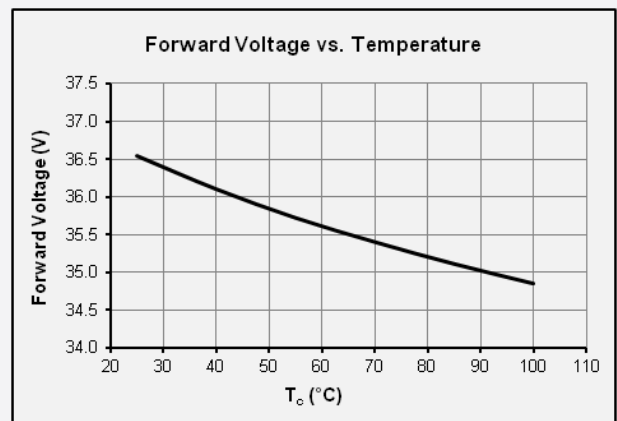
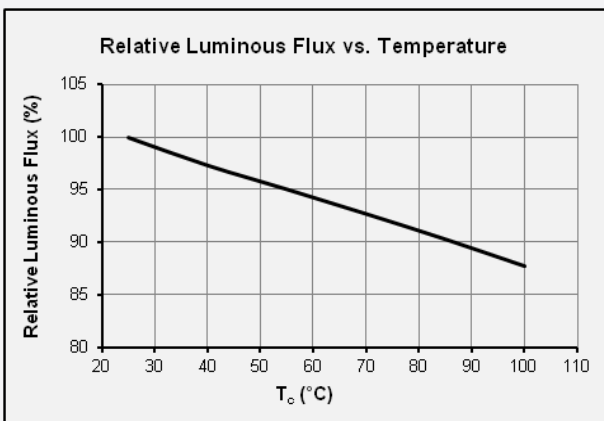

**d) Color Shift Characteristics  $T_a = 25\text{ }^\circ\text{C}$**

$I_f = 240\text{ mA}$

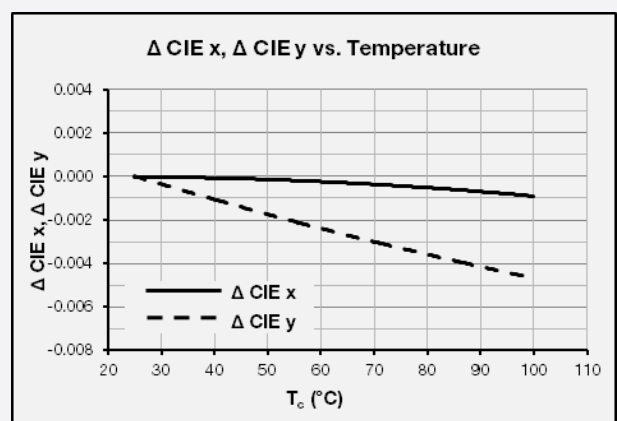
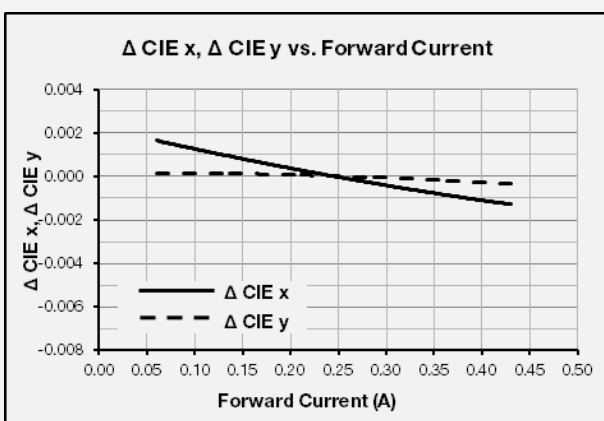

## e) Derating Curve

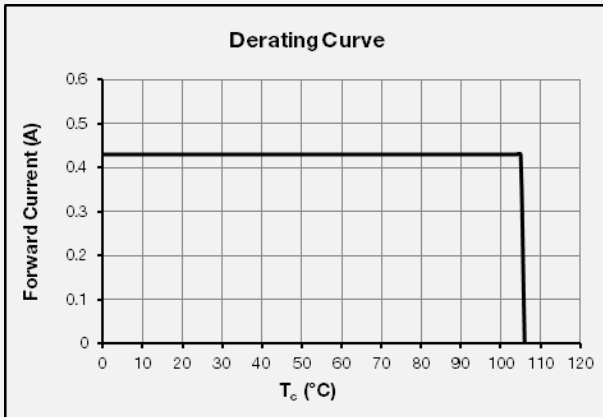
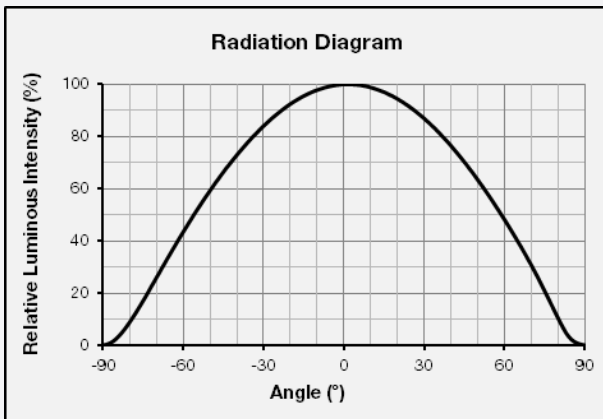
f) Beam Angle Characteristics ( $I_F = 240$  mA,  $T_a = 25$  °C)

#### 4. Outline Drawing & Dimension

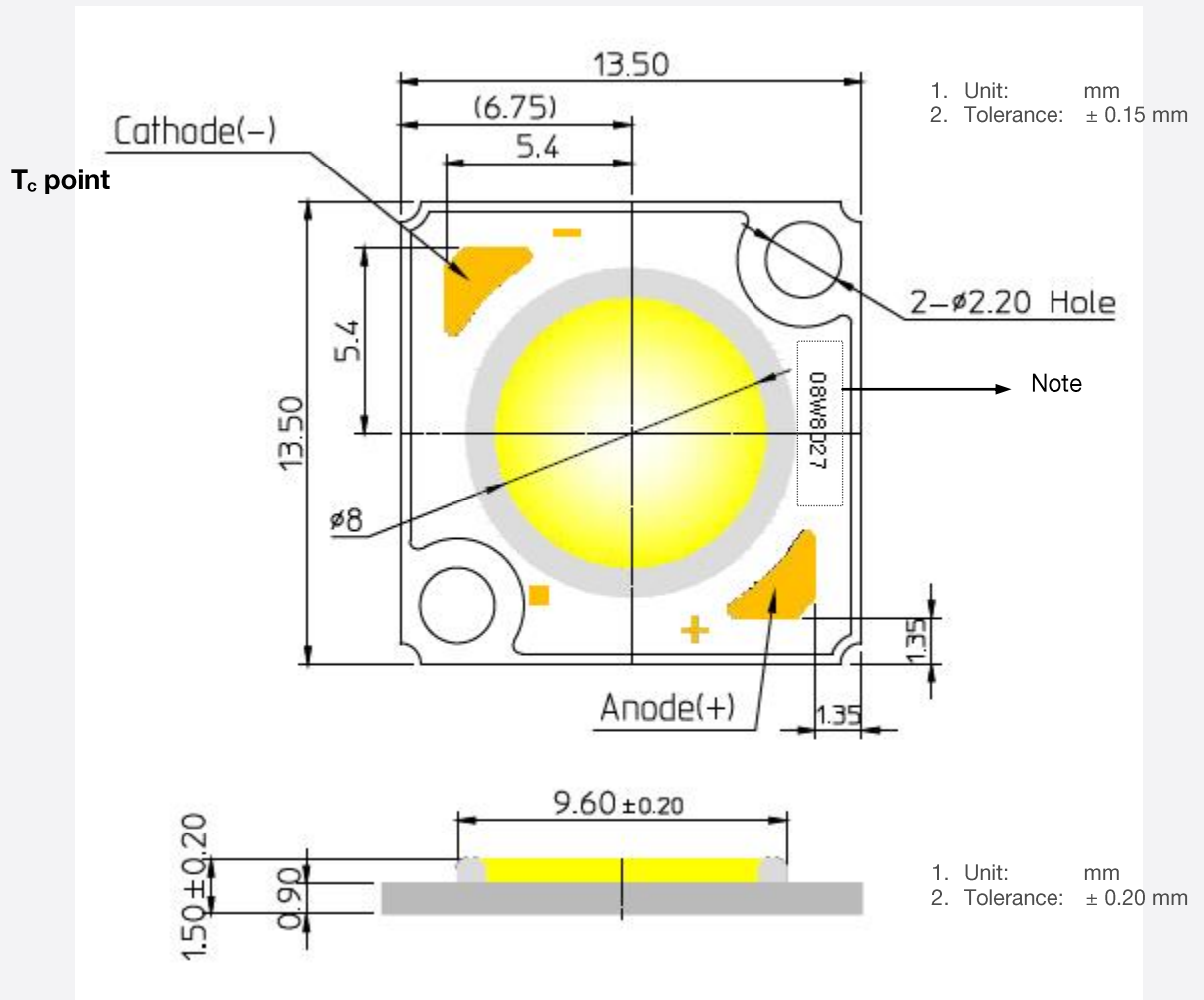

Item	Dimension	Tolerance	Unit
Length	13.50	±0.15	mm
Width	13.50	±0.15	mm
Height	1.50	±0.20	mm
Light Emitting Surface (LES) Diameter	8	±0.15	mm
Screw Hole Size	2.2	±0.15	mm

Note: Denoted product information above is only an example  
( 08W8027 : 8.6W, CRI80+, 2700K )



## 5. Reliability Test Items & Conditions

### a) Test Items

Test Item	Test Condition	Test Hour / Cycle
Room Temperature Life Test	25 °C, $I_F = \text{max}$	1000 h
High Temperature Humidity Life Test	60 °C, 90 % RH, DC Derating, $I_F = \text{max}$	1000 h
High Temperature Life Test	105 °C, DC Derating, $I_F = \text{max}$	1000 h
Low Temperature Life Test	-40 °C, DC 430 mA	1000 h
High Temperature Storage	120 °C	1000 h
Low Temperature Storage	-40 °C	1000 h
Thermal Shock	-45 °C / 15 min ↔ 125 °C / 15 min temperature change in 5 min	200 cycles
Temperature Cycle On/Off Test	-40 °C / 85 °C each 20 min, 100 min transfer power on/off each 5 min, DC 240 mA	100 cycles
ESD (HBM)	$R_1$ : 10 M $\Omega$ $R_2$ : 1.5 k $\Omega$ C: 100 pF V: $\pm 2$ kV	5 times
ESD (MM)	$R_1$ : 10 M $\Omega$ $R_2$ : 0 k $\Omega$ C: 200 pF V: $\pm 0.5$ kV	5 times
Vibration Test	20 ~ 80 Hz (displacement: 0.06 inch, max. 20 g) 80 ~ 2 kHz (max. 20 g) min. frequency ↔ max. frequency 4 min transfer	4 times
Mechanical Shock Test	1500 g, 0.5 ms each of the 6 surfaces (3 axis x 2 sides)	5 times
Salt Spray Test	35 °C, 5 % salt water 8 h spray, 16 h dwell	2 cycles

### b) Criteria for Judging the Damage

Item	Symbol	Test Condition ( $T_c = 25$ °C)	Limit	
			Min.	Max.
Forward Voltage	$V_F$	$I_F = 240$ mA	L.S.L. * 0.9	U.S.L. * 1.1
Luminous Flux	$\Phi_v$	$I_F = 240$ mA	L.S.L * 0.7	U.S.L * 1.3

## 6. Label Structure

### a) Label Structure

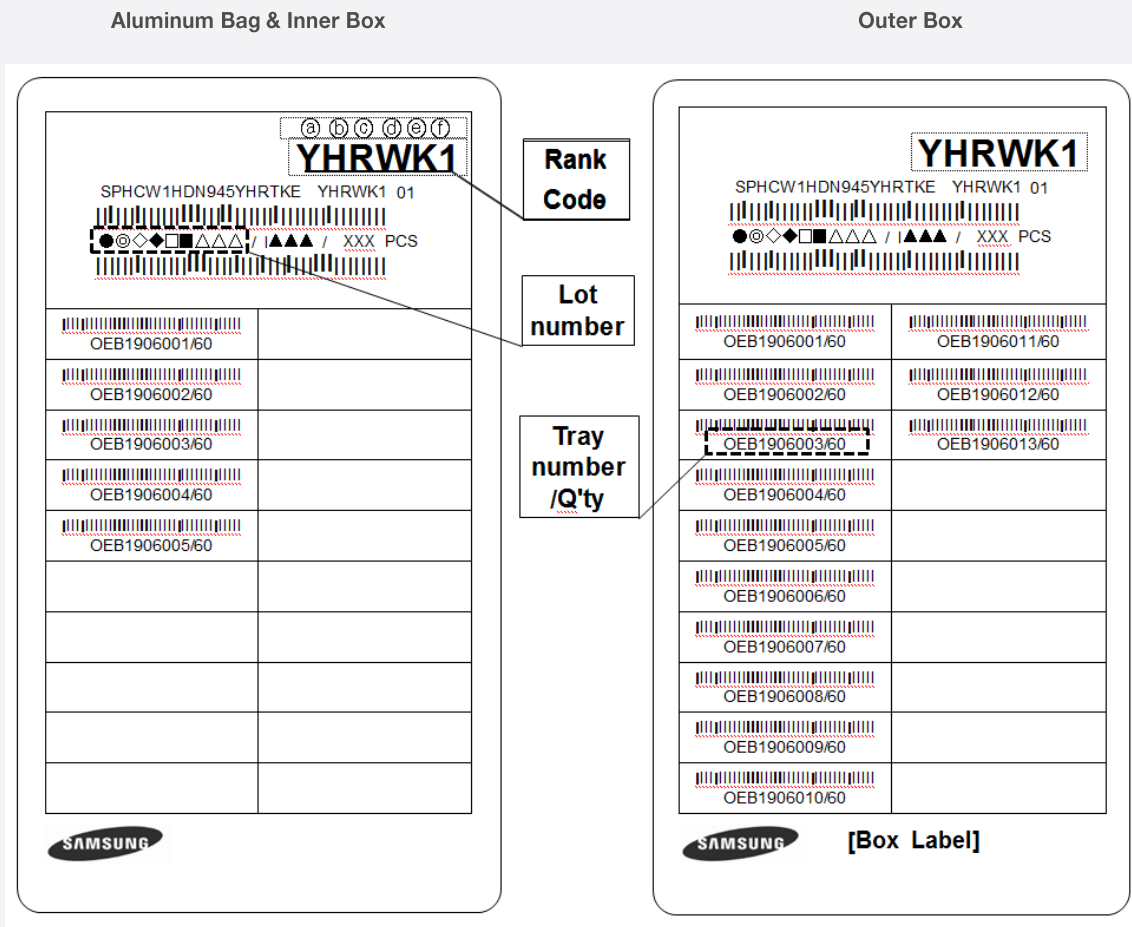

Note: Denoted rank code and product code above is only an example (see description on page 5)

Rank Code:

①②: Forward Voltage rank (refer to page 6-7)

③④: Chromaticity bin (refer to page 8-9)

⑤⑥: Luminous Flux bin (refer to page 6-7)

## b) Lot Number

The lot number is composed of the following characters:

●◎◇◆□■△△△ / 1▲▲▲ / xxx PCS

- : Production site (S: Giheung, Korea, G: Tianjin, China)
- ◎ : L (LED)
- ◇ : Product state (A: Normal, B: Bulk, C: First Production, R: Reproduction, S: Sample)
- ◆ : Year (Y: 2014, Z: 2015, A: 2016, ...)
- : Month (1~9, A, B, C)
- : Day (1~9, A, B~V)
- △△△ : Product serial number (001 ~ 009)
- ▲▲▲ : Tray number (001 ~ 999)

## 7. Packing Structure

Packing material	Max. quantity in pcs of COB	Dimension (mm)			
		Length	Width	Height	Tolerance
Tray	144	322.6	135.9	11	0.25
Aluminum Bag	720 (5 trays)	450	230	-	10
PE Foam Pad	-	280	130	10	2
Inner Box	720 (1 aluminum bag)	338	143	55	2
Outer Box	2880 (4 inner boxes)	346	303	120	5
Pallet	161,280 (56 outer boxes)	1000	1000	970	10

### a) Packing Structure for 5 trays inside Aluminum Bag

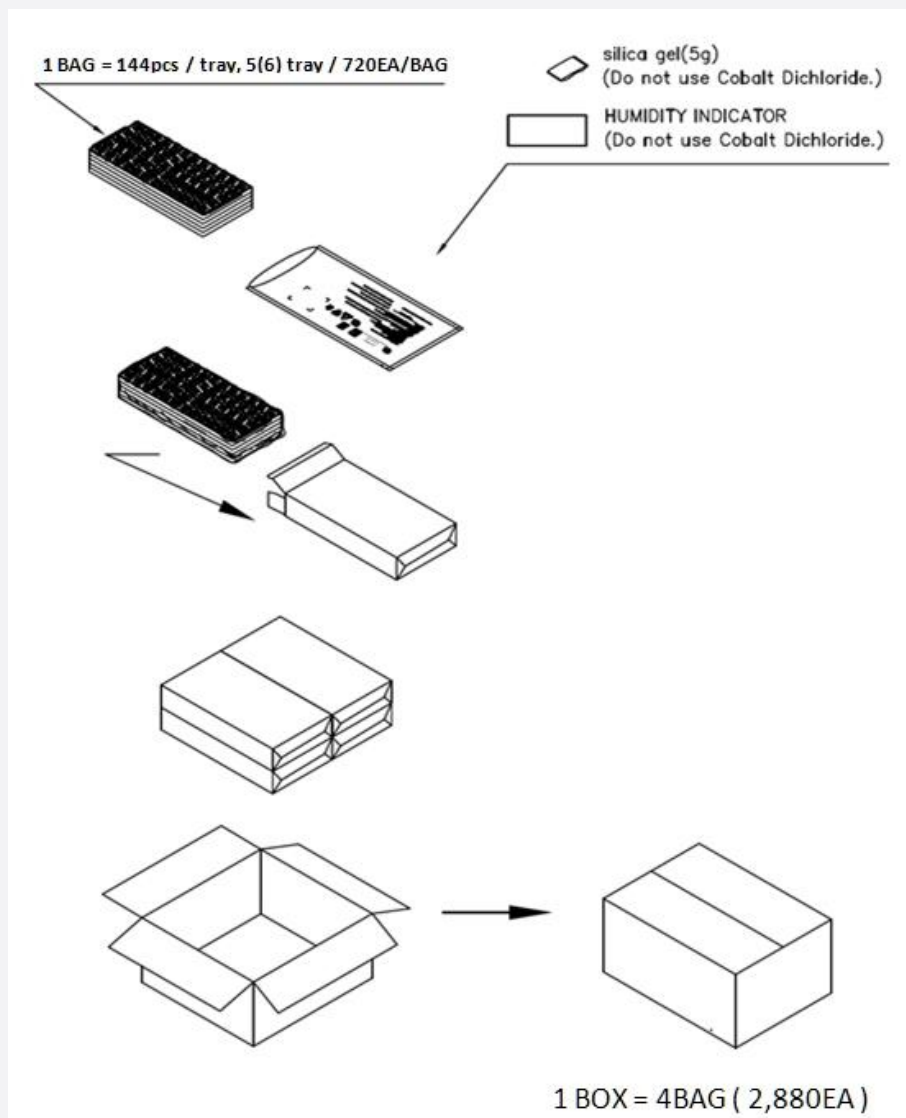

b) Packing Structure for <5 trays inside Aluminum Bag

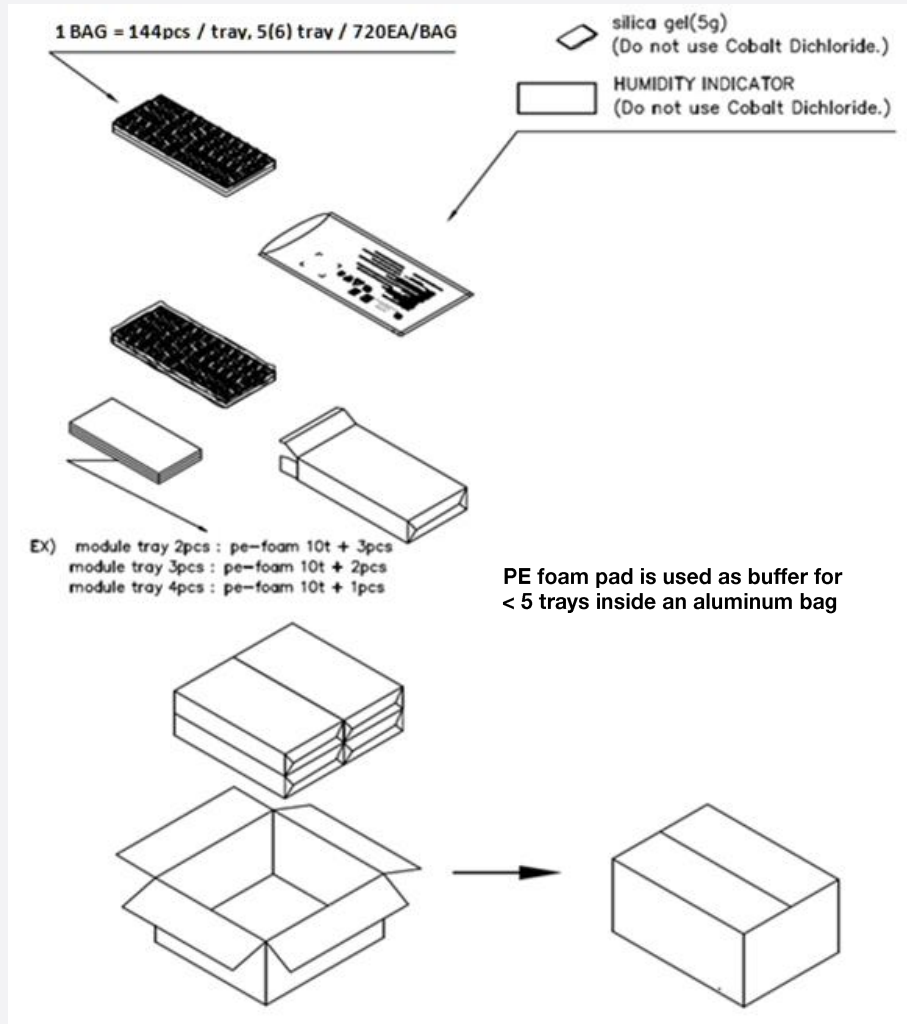

c) Tray

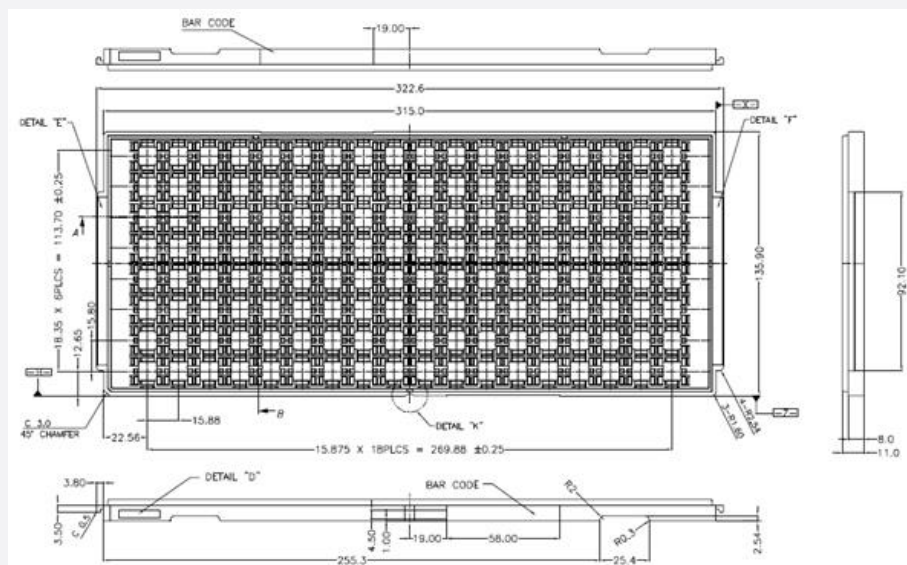

d) Aluminum Vinyl Packing Bag

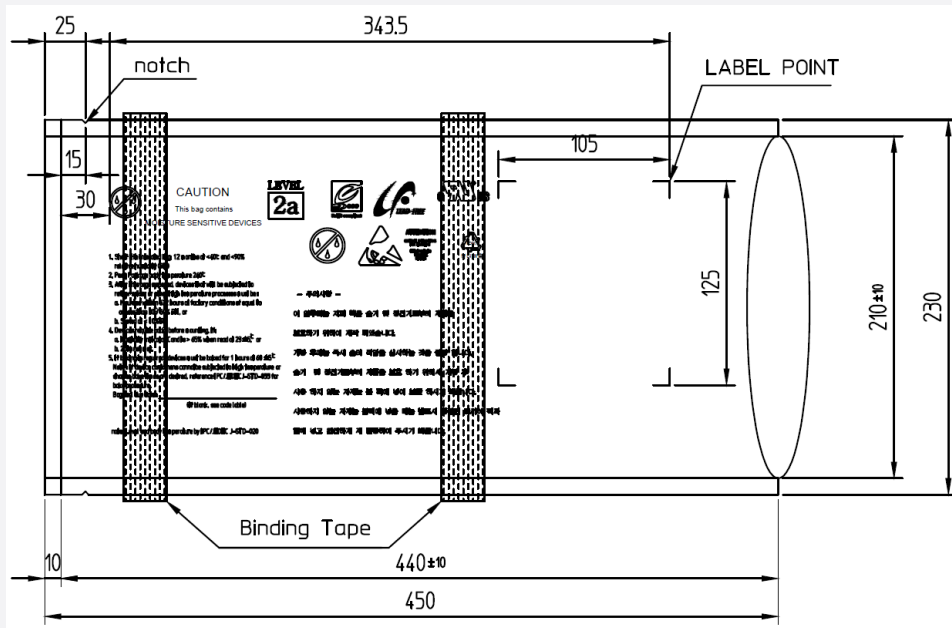

e) Silica Gel & Humidity Indicator Card inside Aluminum Vinyl Packing Bag

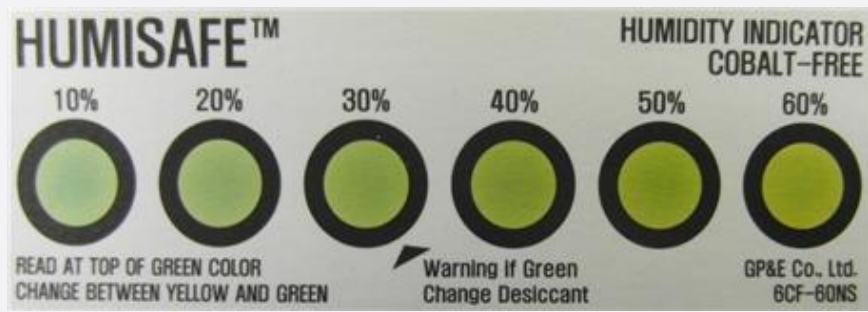

## 8. Precautions in Handling & Use

- 1) This device should not be used in any type of fluid such as water, oil, organic solvent, etc. When cleaning is required, IPA is recommended as the cleaning agent. Some solvent-based cleaning agent may damage the silicone resins used in the device.
- 2) LEDs must be stored in a clean environment. If the LEDs are to be stored for three months or more after being shipped from Samsung, they should be packed with a nitrogen-filled container (shelf life of sealed bags is 12 months at temperature 0~40 °C, 0~90 % RH).
- 3) After storage bag is opened, device subjected to soldering, solder reflow, or other high temperature processes must be:
  - a. Mounted within 672 hours (28 days) at an assembly line with a condition of no more than 30 °C / 60 % RH, or
  - b. Stored at <10 % RH
- 4) Repack unused products with anti-moisture packing, fold to close any opening and then store in a dry place.
- 5) Devices require baking before mounting, if humidity card reading is >60 % at 23 ± 5 °C.
- 6) Devices must be baked for 1 hour at 60 ± 5 °C, if baking is required.
- 7) The LEDs are sensitive to the static electricity and surge current. It is recommended to use a wrist band or anti-electrostatic glove when handling the LEDs. If voltage exceeding the absolute maximum rating is applied to LEDs, it may cause damage or even destruction to LED devices. Damaged LEDs may show some unusual characteristics such as increase in leakage current, lowered turn-on voltage, or abnormal lighting of LEDs at low current.
- 8) VOCs (Volatile Organic Compounds) can be generated from adhesives, flux, hardener or organic additives used in luminaires (fixtures). Transparent LED silicone encapsulant is permeable to those chemicals and they may lead to a discoloration of encapsulant when they exposed to heat or light. This phenomenon can cause a significant loss of light emitted (output) from the luminaires. In order to prevent these problems, we recommend users to know the physical properties of materials used in luminaires and they must be carefully selected.
- 9) The resin area is very sensitive, please do not handle, press, touch, rub, clean, or pick by with tweezers on it. Instead, please pick at the handling area as indicated below.

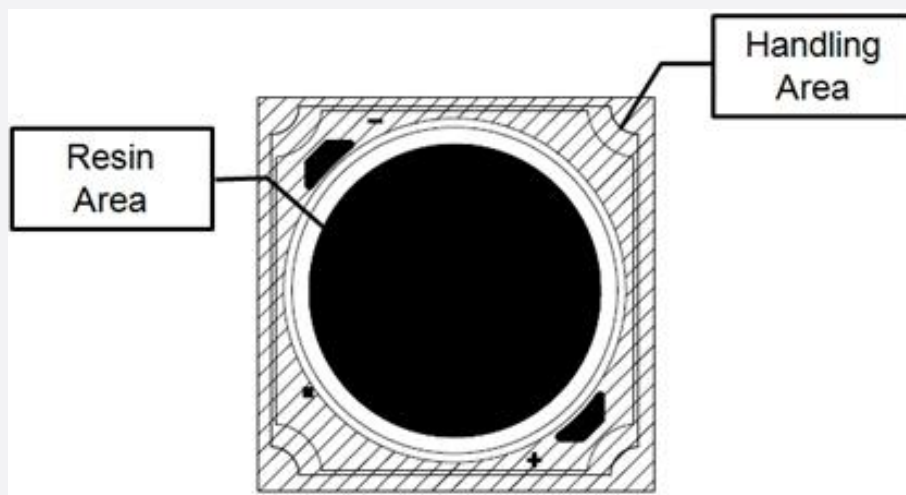

# Legal and additional information.

## [About Samsung Electronics Co., Ltd.](#)

Samsung Electronics Co., Ltd. inspires the world and shapes the future with transformative ideas and technologies, redefining the worlds of TVs, smartphones, wearable devices, tablets, cameras, digital appliances, printers, medical equipment, network systems and semiconductors.

We are also leading in the Internet of Things space through, among others, our Digital Health and Smart Home initiatives. We employ 307,000 people across 84 countries. To discover more, please visit our official website at [www.samsung.com](http://www.samsung.com) and our official blog at [global.samsungtomorrow.com](http://global.samsungtomorrow.com).

Copyright © 2015 Samsung Electronics Co., Ltd. All rights reserved.

Samsung is a registered trademark of Samsung Electronics Co., Ltd.

Specifications and designs are subject to change without notice. Non-metric weights and measurements are approximate. All data were deemed correct at time of creation. Samsung is not liable for errors or omissions. All brand, product, service names and logos are trademarks and/or registered trademarks of their respective owners and are hereby recognized and acknowledged.

Samsung Electronics Co., Ltd.

95, Samsung 2-ro

Giheung-gu

Yongin-si, Gyeonggi-do, 446-711

KOREA

[www.samsungled.com](http://www.samsungled.com)

