



Chipsmall Limited consists of a professional team with an average of over 10 year of expertise in the distribution of electronic components. Based in Hongkong, we have already established firm and mutual-benefit business relationships with customers from,Europe,America and south Asia,supplying obsolete and hard-to-find components to meet their specific needs.

With the principle of “Quality Parts,Customers Priority,Honest Operation,and Considerate Service”,our business mainly focus on the distribution of electronic components. Line cards we deal with include Microchip,ALPS,ROHM,Xilinx,Pulse,ON,Everlight and Freescale. Main products comprise IC,Modules,Potentiometer,IC Socket,Relay,Connector.Our parts cover such applications as commercial,industrial, and automotives areas.

We are looking forward to setting up business relationship with you and hope to provide you with the best service and solution. Let us make a better world for our industry!



Contact us

Tel: +86-755-8981 8866 Fax: +86-755-8427 6832

Email & Skype: info@chipsmall.com Web: www.chipsmall.com

Address: A1208, Overseas Decoration Building, #122 Zhenhua RD., Futian, Shenzhen, China



High Power LED Series
Chip on Board

Vivid Color COB



High efficacy COB LED package,
well-suited for use in spotlight applications

Features & Benefits

- Chip on Board (COB) solution makes it easy to design in
- Simple assembly reduces manufacturing cost
- Low thermal resistance
- InGaN/GaN MQW LED with long time reliability

Applications

- Spotlight / Downlight
- LED Retrofit Bulbs
- Outdoor Illumination



Table of Contents

1.	Characteristics	-----	3
2.	Product Code Information	-----	7
3.	Typical Characteristics Graphs	-----	10
4.	Outline Drawing & Dimension	-----	20
5.	Reliability Test Items & Conditions	-----	24
6.	Label Structure	-----	25
7.	Packing Structure	-----	27
8.	Precautions in Handling & Use	-----	32

1. Characteristics

a) Absolute Maximum Rating

Item	Symbol	Model	Rating	Unit	Condition
Ambient / Operating Temperature	T_a	-	-40 ~ +105	°C	-
Storage Temperature	T_{stg}	-	-40 ~ +120	°C	-
LED Junction Temperature	T_j	-	140	°C	-
Case Temperature	T_c	-	105	°C	*Note
Forward Current	I_F	LC006B	320	mA	-
		LC008B	430		
		LC013B	660		
		LC019B	980		
		LC026B	1300		
		LC033B	1620		
		LC040B	1900		
		Power Dissipation	P_D		
LC008B	15.8				
LC013B	24.4				
LC019B	36.3				
LC026B	48.1				
LC033B	59.9				
LC040B	70.3				
ESD (HBM)	-			-	±2
ESD (MM)	-	-	±0.5	kV	-

b) Electro-optical Characteristics

Item	Unit	Model	Rank	Min.	Typ.	Max.
Forward Voltage (V _F)	V	LC006B	YH	32.5	35.5	38.5
		LC008B	YH	33.5	36.5	39.5
		LC013B	YH	32.5	35.5	38.5
		LC019B	YH	32.5	35.5	38.5
		LC026B	YH	32.5	35.5	38.5
		LC033B	YH	32.5	35.5	38.5
		LC040B	YH	32.5	35.5	38.5
Thermal Resistance (junction to chip point)	°C/W	LC006B	-	-	2.4	-
		LC008B	-	-	2.0	-
		LC013B	-	-	1.6	-
		LC019B	-	-	1.5	-
		LC026B	-	-	0.9	-
		LC033B	-	-	0.9	-
		LC040B	-	-	0.8	-
Beam Angle	°			-	115	-
Nominal Power	W	LC006B	-	-	6.4	-
		LC008B	-	-	8.6	-
		LC013B	-	-	12.8	-
		LC019B	-	-	19.2	-
		LC026B	-	-	25.6	-
		LC033B	-	-	32.0	-
		LC040B	-	-	38.3	-

Notes:

- 1) The COB is tested in pulsed condition at rated test current (10 ms pulse width) and rated temperature ($T_j = T_c = T_a = 25\text{ °C}$)
- 2) Samsung maintains measurement tolerance of: forward voltage = $\pm 5\%$, CRI = ± 1
- 3) Max $T_c=105\text{ °C}$ is for ENEC condition. Refer to the derating curve, '3. Typical Characteristics Graph' designed within the range.

c) Luminous Flux Characteristics

Model	Nominal CCT (K)	Flux Rank	Flux Bin	Sorting ¹⁾ @ T _c = 25 °C (lm)		Calculated Flux ²⁾ @ T _c = 85 °C (lm)	
				Min.	Max.	Min.	Max.
LC006B	3000	CF	C1	663	754	604	686
			C2	754	844	686	768
	3500	CF	C1	683	776	622	706
			C2	776	869	706	791
	4000	CF	C1	703	799	640	727
			C2	799	895	727	814
LC008B	3000	FG	F1	887	1007	807	917
			F2	1007	1128	917	1027
	3500	FG	F1	913	1038	831	944
			F2	1038	1162	944	1058
	4000	FG	F1	940	1068	855	972
			F2	1068	1196	972	1088
LC013B	3000	1F	11	1347	1531	1226	1393
			12	1531	1715	1393	1560
	3500	1F	11	1374	1562	1250	1421
			12	1562	1749	1421	1592
	4000	1F	11	1415	1608	1288	1464
			12	1608	1801	1464	1639
LC019B	3000	2F	21	1980	2250	1802	2048
			22	2250	2521	2048	2294
	3500	2F	21	2020	2295	1838	2089
			22	2295	2571	2089	2340
	4000	2F	21	2040	2318	1856	2109
			22	2318	2596	2109	2362
LC026B	3000	2J	21	2694	3062	2452	2786
			22	3062	3429	2786	3121
	3500	2J	21	2748	3123	2501	2842
			22	3123	3498	2842	3183
	4000	2J	21	2775	3154	2526	2870
			22	3154	3532	2870	3214
LC033B	3000	3P	31	3301	3751	3004	3413
			32	3751	4201	3413	3823
	3500	3P	31	3367	3826	3064	3481
			32	3826	4285	3481	3899
	4000	3P	31	3400	3863	3094	3516
			32	3863	4327	3516	3937

LC040B	3000	4J	41	3880	4409	3531	4012
			42	4409	4938	4012	4494
	3500	4J	41	3958	4497	3601	4093
			42	4497	5037	4093	4584
	4000	4J	41	3996	4541	3637	4133
			42	4541	5086	4133	4629

Notes:

- 1) The COB is tested in pulsed condition at rated test current (10 ms pulse width) and rated temperature ($T_j = T_c = T_a = 25\text{ }^\circ\text{C}$)
- 2) Calculated flux values are for reference only
- 3) Samsung maintains measurement tolerance of: luminous flux = $\pm 7\%$, CRI = ± 1

2. Product Code Information

1	2	3	4	5	6	7	8	9	10	11	12	13	14	15	16	17	18
S	P	H	W	W	1	H	D	N	A	2	V	Y	H	V	3	1	F

Digit	PKG Information	Code	Specification
1 2 3	Samsung Package High Power	SPH	
4 5	Color	WW	Warm White (T/U/V/W Ranks)
6	Product Version	1	
7 8	Form Factor	HD	COB
9	Lens Type	N	No lens
10	Internal Code	8	LC006
		9	LC008
		A	LC013
		B	LC019
		C	LC026
		D	LC033
		E	LC040
11	Chip Type	2	
		4	
12	CRI & Sorting Temperature	V	VIVID 25 °C
13 14	Forward Voltage (V)	YH	32.5~38.5
			33.5~39.5
15	CCT (K)	V	3000 K V3
		U	3500 K <small>Bin Code</small> U3
		T	4000 K T3
16	MacAdam	3	MacAdam3-step
17 18	Luminous Flux	CF	C1, C2
		FG	F1, F2
		1F	11, 12
		2F	<small>Bin Code:</small> 21, 22
		2J	21, 22
		3P	31, 32
		4J	41, 42

a) Binning Structure ($T_a = 25\text{ }^\circ\text{C}$)

Model	Nominal CCT (K)	Product Code	V_F Rank	Color Rank	Chrom. Bin	Flux Rank	Flux Bin	Flux Range (Φ_v , lm)
LC006B	3000	SPHWW1HDN82VYHV3CF	YH	V3	V3	CF	C1	663 ~ 754
							C2	754 ~ 844
	3500	SPHWW1HDN82VYHU3CF	YH	U3	U3	CF	C1	683 ~ 776
							C2	776 ~ 869
	4000	SPHWW1HDN82VYHT3CF	YH	T3	T3	CF	C1	703 ~ 799
							C2	799 ~ 895
LC008B	3000	SPHWW1HDN94VYHV3FG	YH	V3	V3	FG	F1	887 ~ 1007
							F2	1007 ~ 1128
	3500	SPHWW1HDN94VYHU3FG	YH	U3	U3	FG	F1	913 ~ 1038
							F2	1038 ~ 1162
	4000	SPHWW1HDN94VYHT3FG	YH	T3	T3	FG	F1	940 ~ 1068
							F2	1068 ~ 1801
LC013B	3000	SPHWW1HDNA2VYHV31F	YH	V3	V3	1F	11	1347 ~ 1531
							12	1531 ~ 1715
	3500	SPHWW1HDNA2VYHU31F	YH	U3	U3	1F	11	1374 ~ 1562
							12	1562 ~ 1749
	4000	SPHWW1HDNA2VYHT31F	YH	T3	T3	1F	11	1415 ~ 1608
							12	1608 ~ 1801
LC019B	3000	SPHWW1HDNB2VYHV32F	YH	V3	V3	2F	21	1980 ~ 2250
							22	2250 ~ 2521
	3500	SPHWW1HDNB2VYHU32F	YH	U3	U3	2F	21	2020 ~ 2295
							22	2295 ~ 2571
	4000	SPHWW1HDNB2VYHT32F	YH	T3	T3	2F	21	2040 ~ 2318
							22	2318 ~ 2596
LC026B	3000	SPHWW1HDNC2VYHV32J	YH	V3	V3	2J	21	2694 ~ 3062
							22	3062 ~ 3429
	3500	SPHWW1HDNC2VYHU32J	YH	U3	U3	2J	21	2748 ~ 3123
							22	3123 ~ 3498
	4000	SPHWW1HDNC2VYHT32J	YH	T3	T3	2J	21	2775 ~ 3154
							22	3154 ~ 3532
LC033B	3000	SPHWW1HDND2VYHV33P	YH	V3	V3	3P	31	3301 ~ 3751
							32	3751 ~ 4201
	3500	SPHWW1HDND2VYHU33P	YH	U3	U3	3P	31	3367 ~ 3826
							32	3826 ~ 4285
	4000	SPHWW1HDND2VYHT33P	YH	T3	T3	3P	31	3400 ~ 3863
							32	3863 ~ 4327
LC040B	3000	SPHWW1HDNE2VYHV34J	YH	V3	V3	4J	41	3880 ~ 4409
							42	4409 ~ 4938
	3500	SPHWW1HDNE2VYHU34J	YH	U3	U3	4J	41	3958 ~ 4497
							42	4497 ~ 5037
	4000	SPHWW1HDNE2VYHT34J	YH	T3	T3	4J	41	3996 ~ 4541
							42	4541 ~ 5086

b) Chromaticity Region & Coordinates ($T_a = 25\text{ }^\circ\text{C}$)

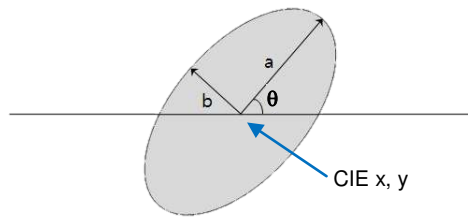
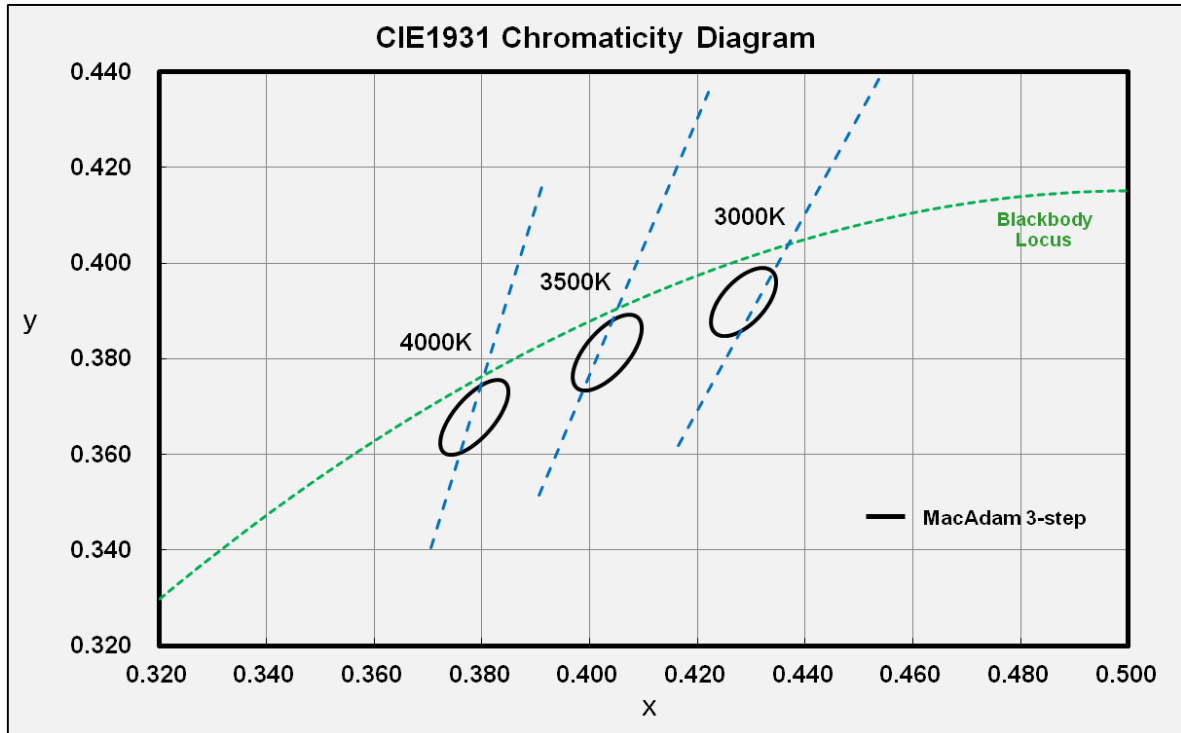

MacAdam Ellipse (V3)					
Step	CIE x	CIE y	θ	a	b
3-step	0.4286	0.3919	53.22	0.0084	0.0042

MacAdam Ellipse (U3)					
Step	CIE x	CIE y	θ	a	b
3-step	0.4033	0.3813	54.00	0.0093	0.0042

MacAdam Ellipse (T3)					
Step	CIE x	CIE y	θ	a	b
3-step	0.3785	0.3677	53.72	0.0093	0.0039

Note:

Samsung maintains measurement tolerance of: $C_x, C_y = \pm 0.005$

3. Typical Characteristics Graphs

a) Spectrum Distribution ($T_a = 25\text{ }^\circ\text{C}$)

CCT: 3000 K

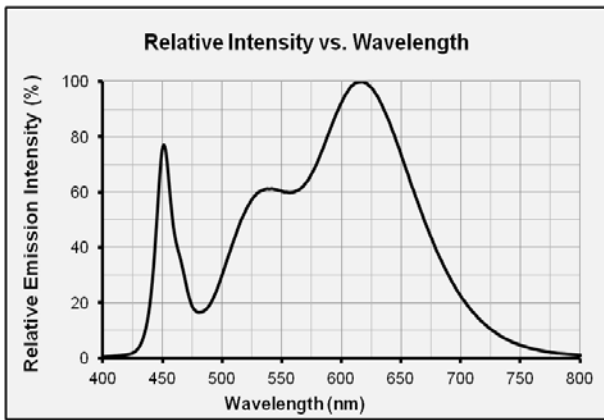

b) LC006B Characteristics

$T_c = 25\text{ }^\circ\text{C}$

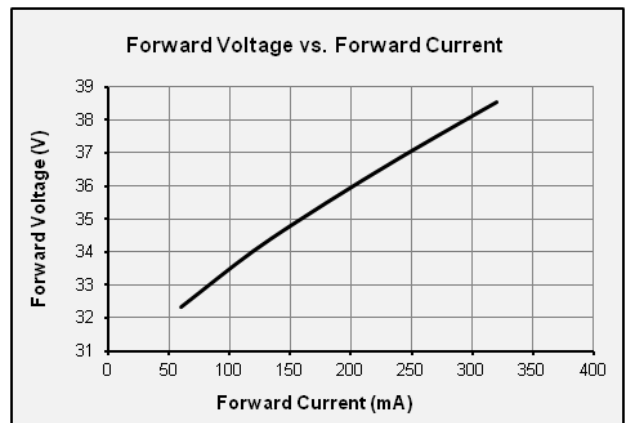
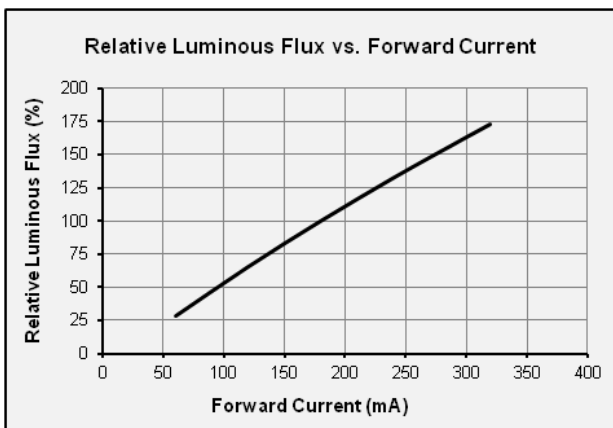

$I_f = 180\text{ mA}$

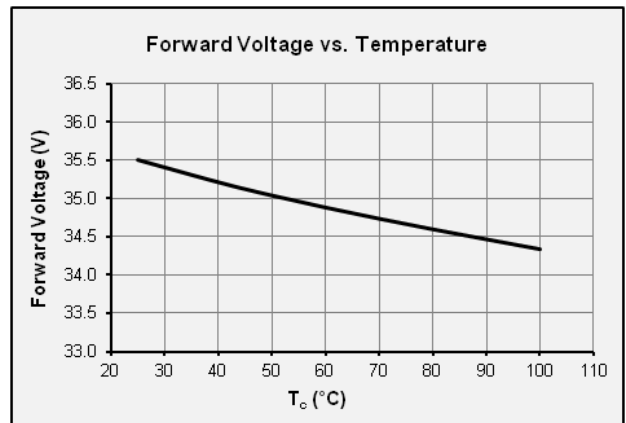
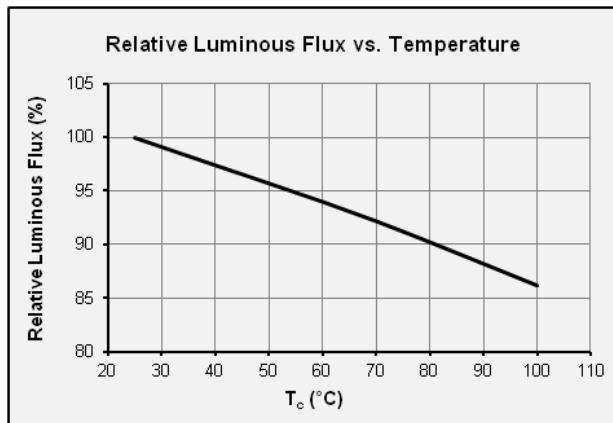

$T_c = 25^\circ\text{C}$

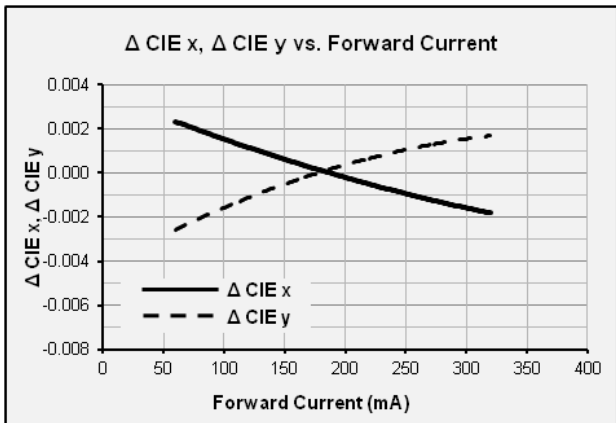

$I_f = 180\text{mA}$

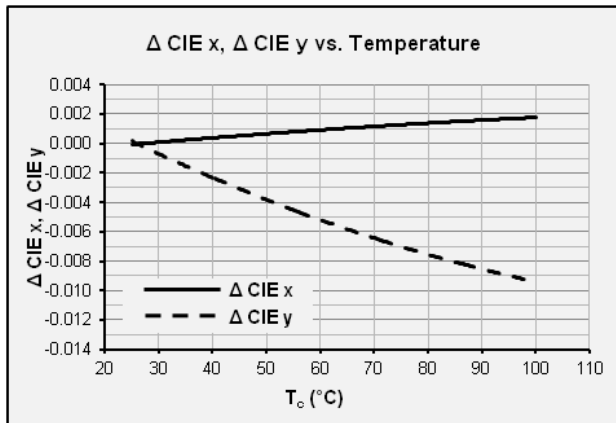

Derating Curve

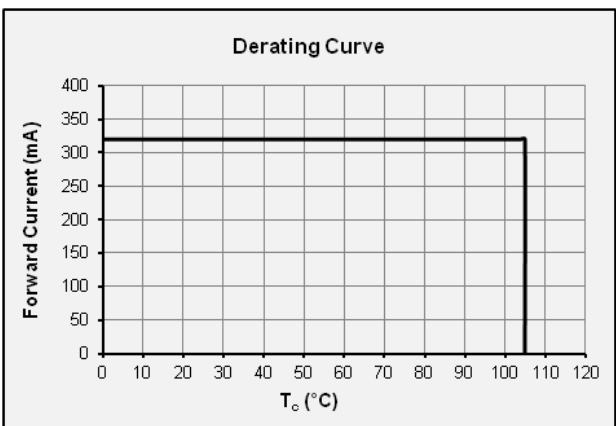

Beam Angle

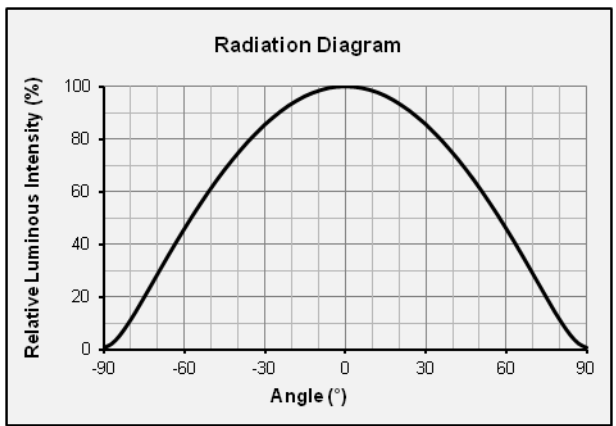

c) LC008B Characteristics

$T_c = 25^\circ\text{C}$

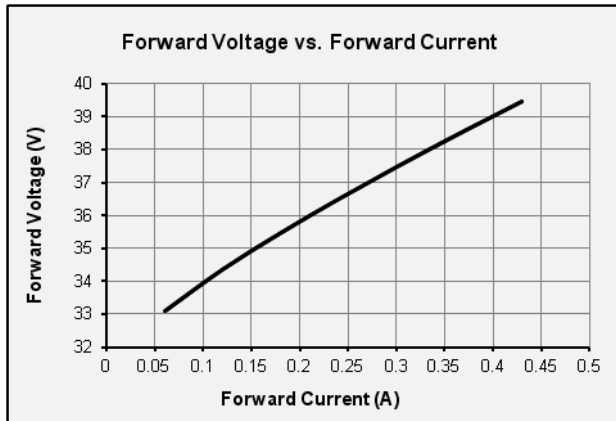
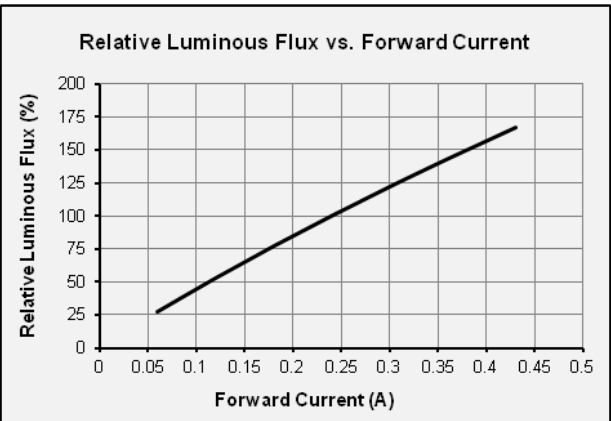

$I_f = 240mA$

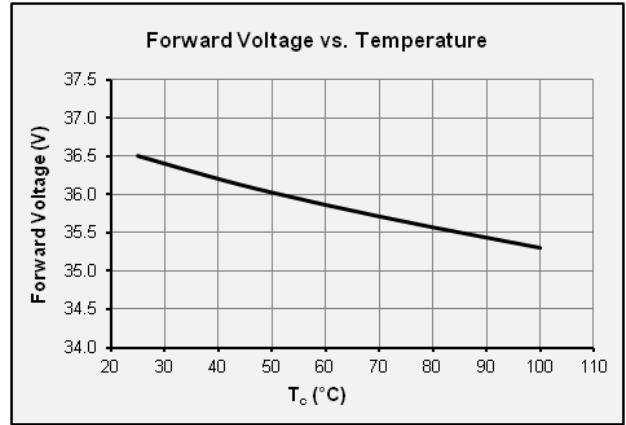
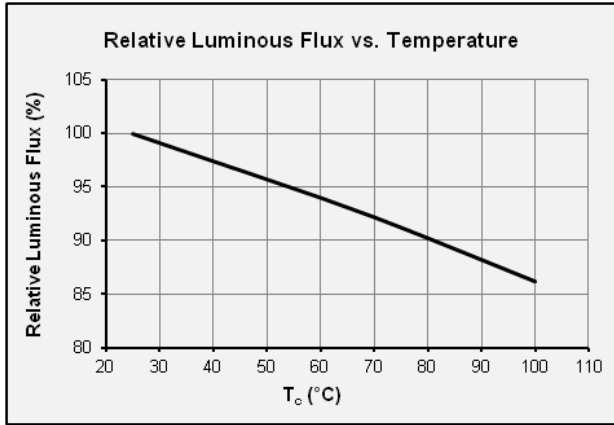

$T_c = 25^\circ C$

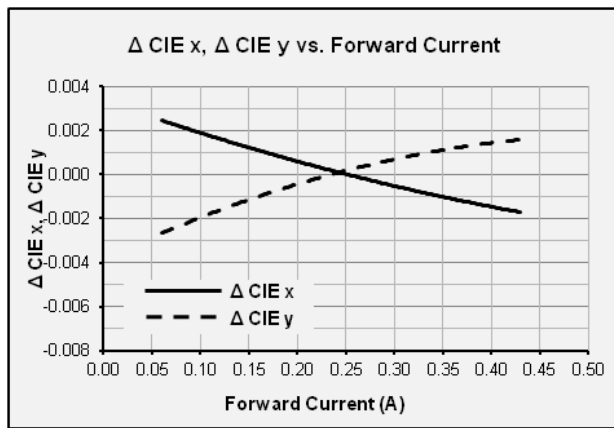

$I_f = 240mA$

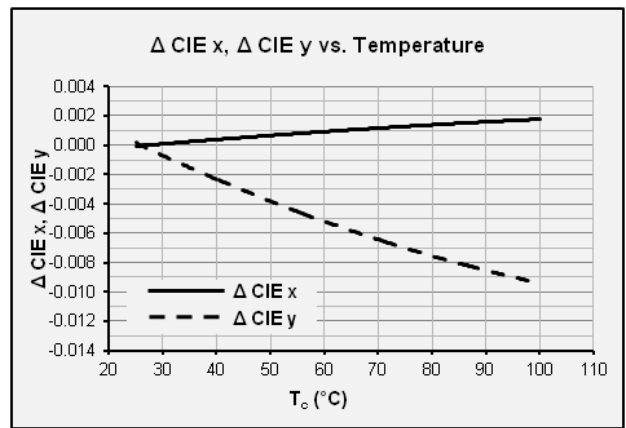

Derating Curve

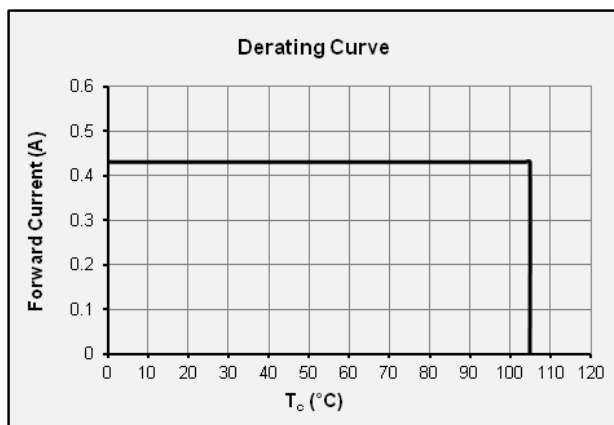

Beam Angle

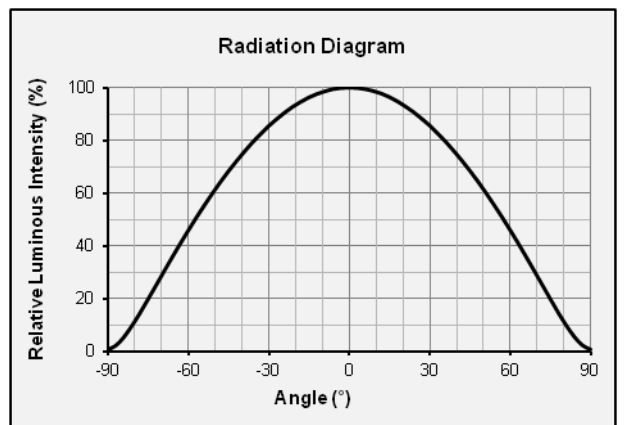

d) LC013B Characteristics

$T_c = 25\text{ }^\circ\text{C}$

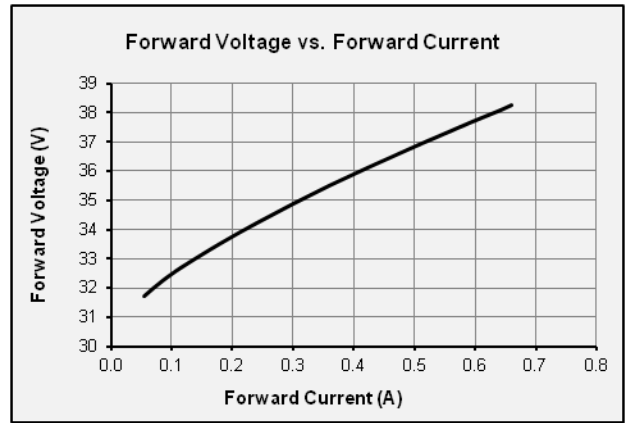
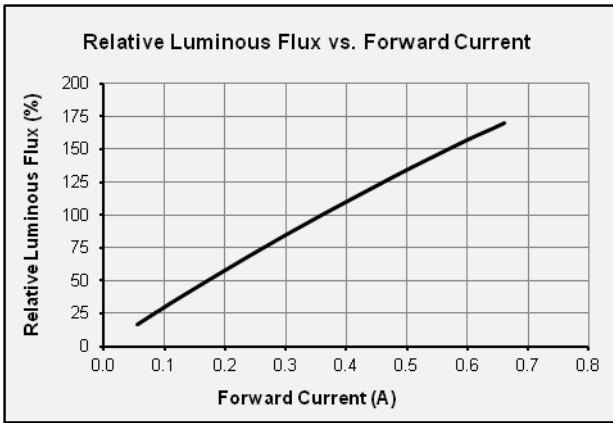

$I_f = 360\text{mA}$

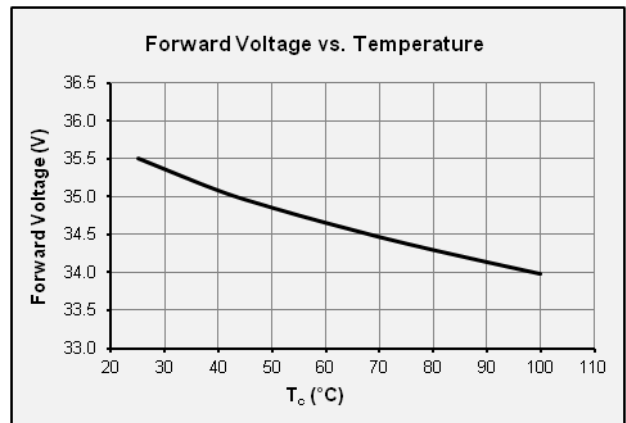
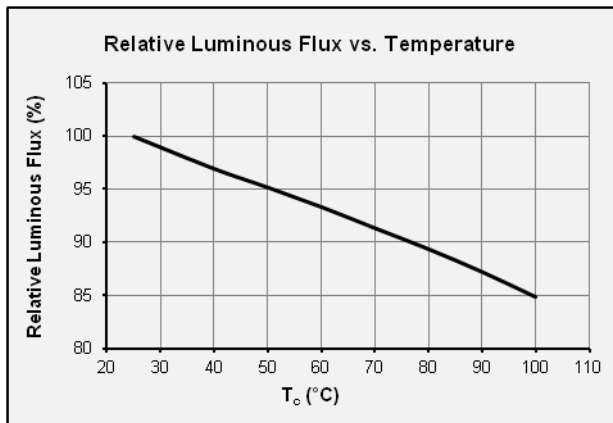

$T_c = 25\text{ }^\circ\text{C}$

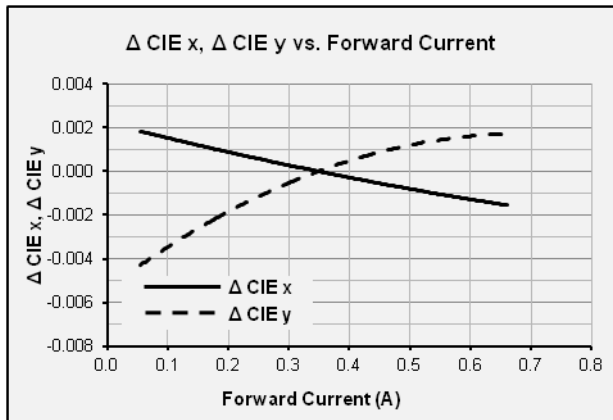

$I_f = 360\text{mA}$

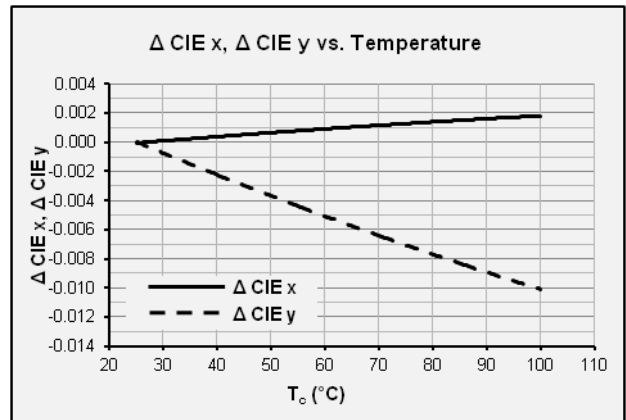

Derating Curve

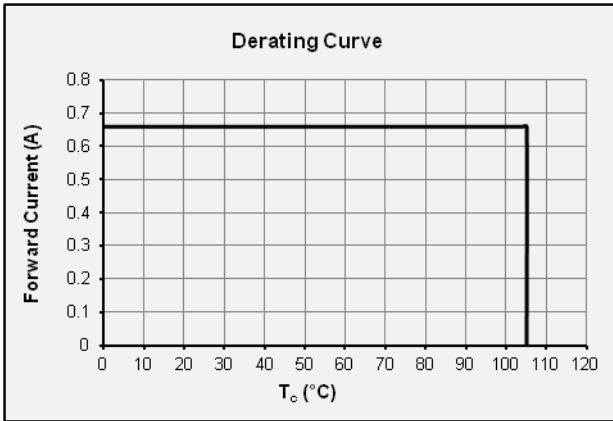

Beam Angle

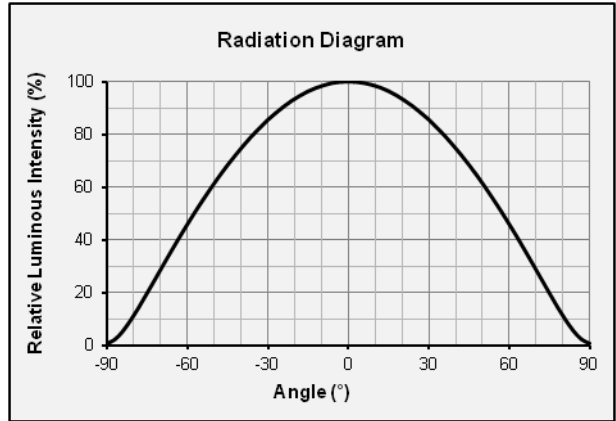

e) LC019B Characteristics

$T_c = 25\text{ }^\circ\text{C}$

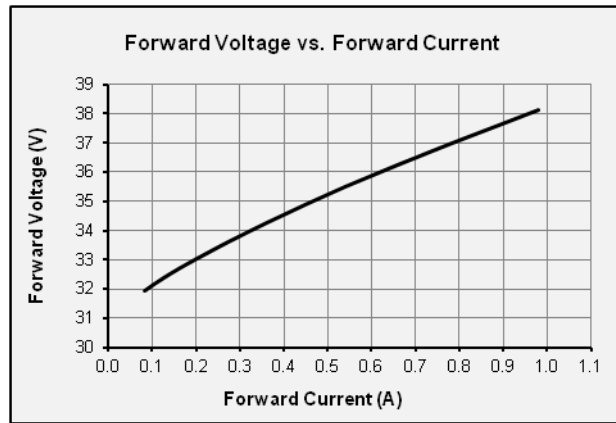
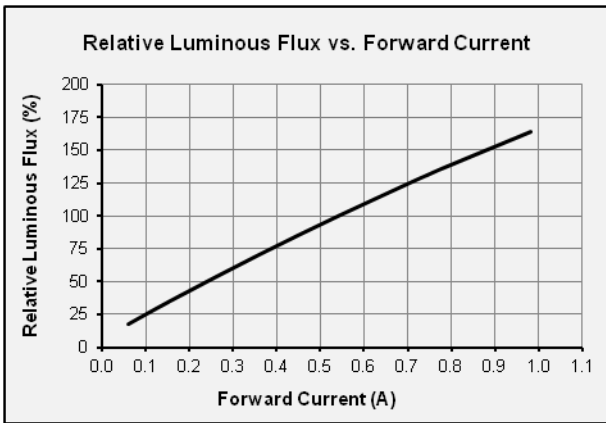

$I_f = 540\text{mA}$

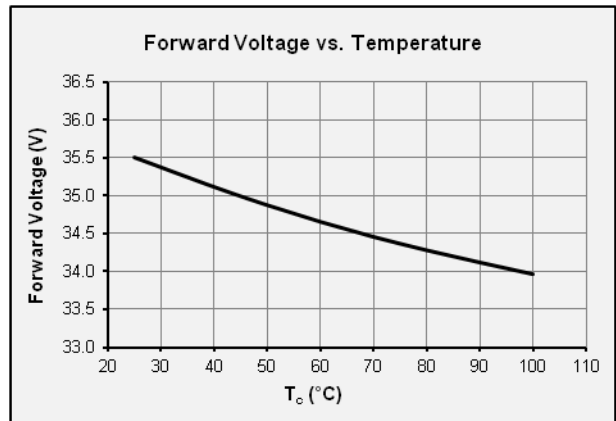
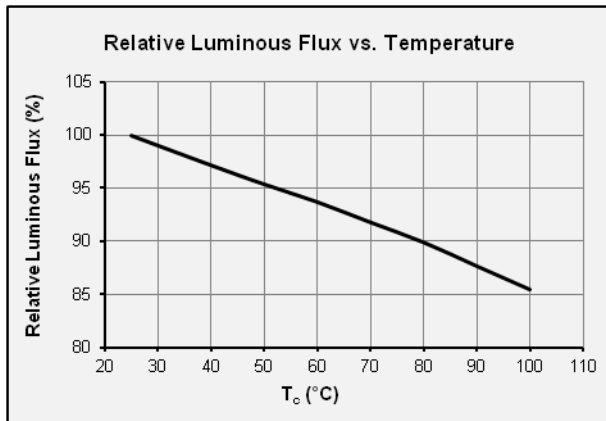

$T_c = 25^\circ\text{C}$

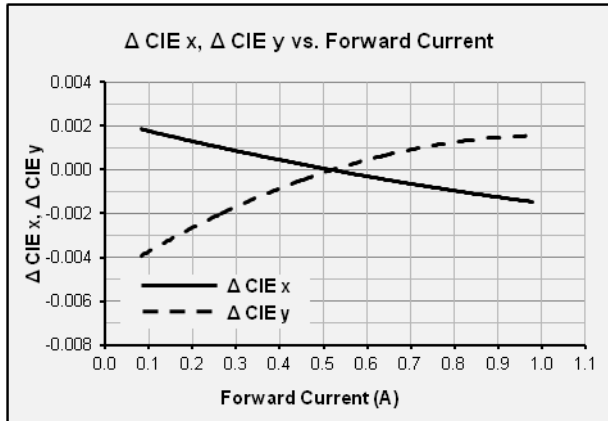

$I_f = 540\text{mA}$

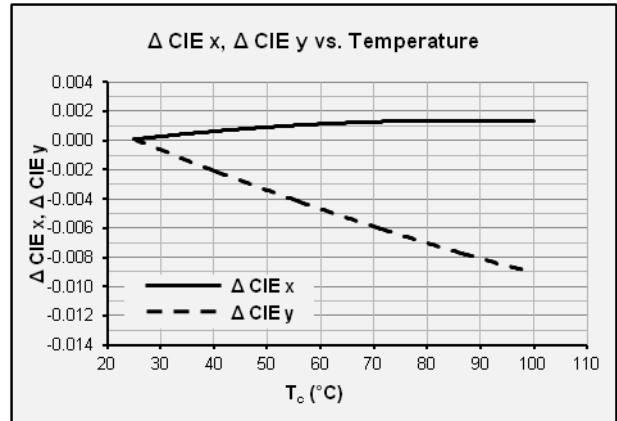

Derating Curve

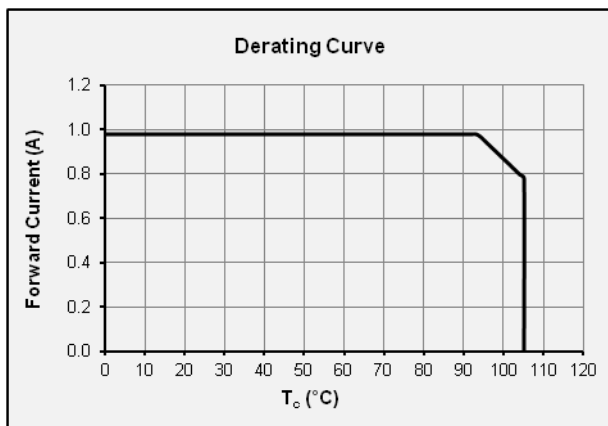

Beam Angle

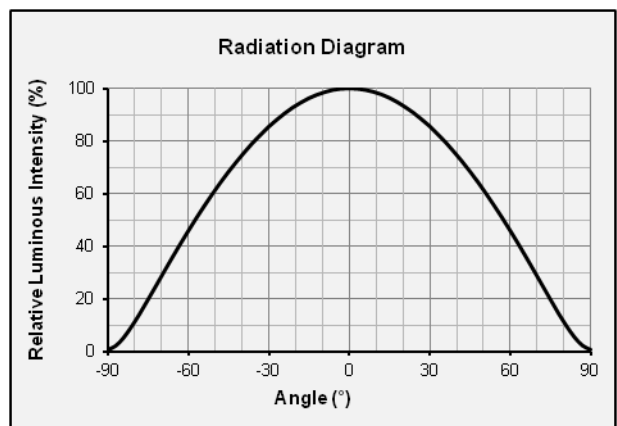

f) LC026B Characteristics

$T_c = 25^\circ\text{C}$

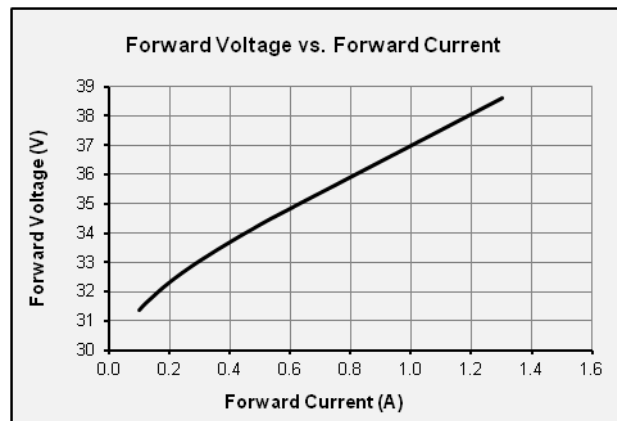
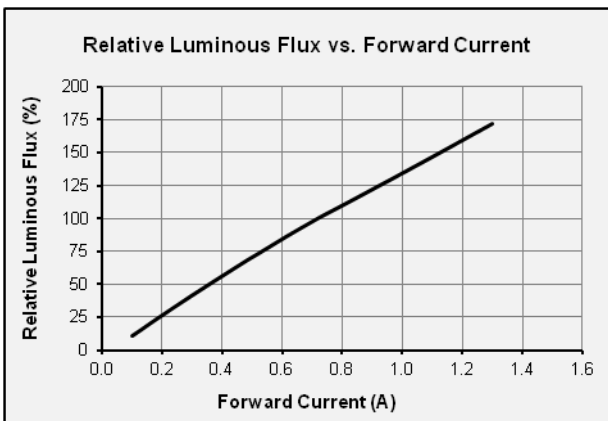

$I_f = 720mA$

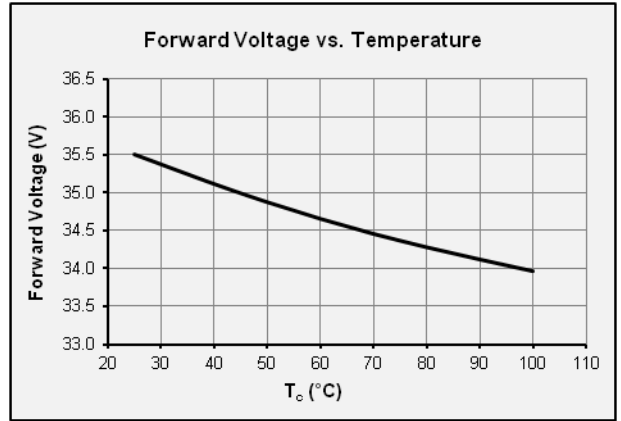
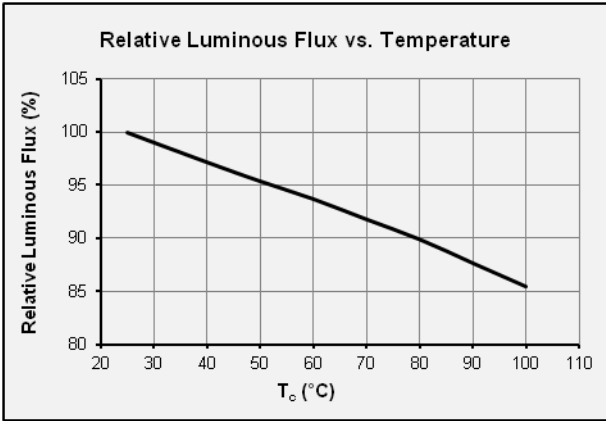

$T_c = 25\text{ }^\circ\text{C}$

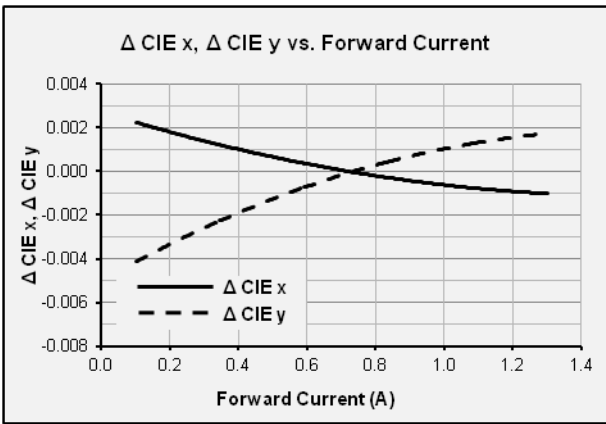

$I_f = 720mA$

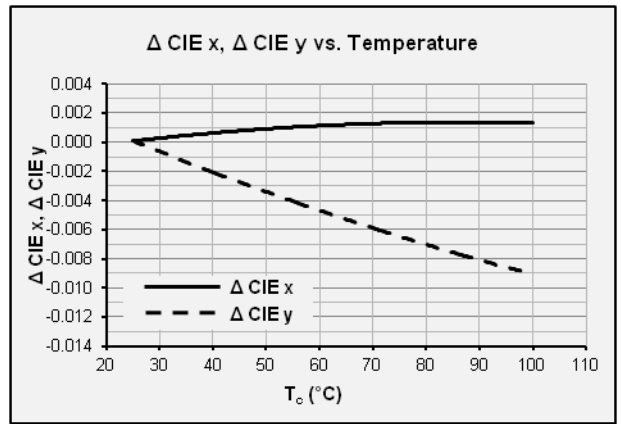

Derating Curve

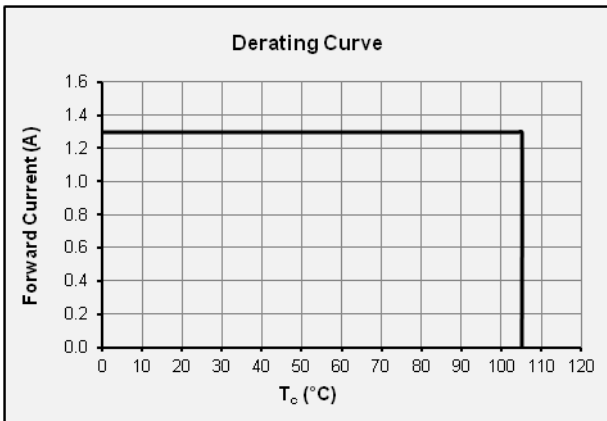

Beam Angle

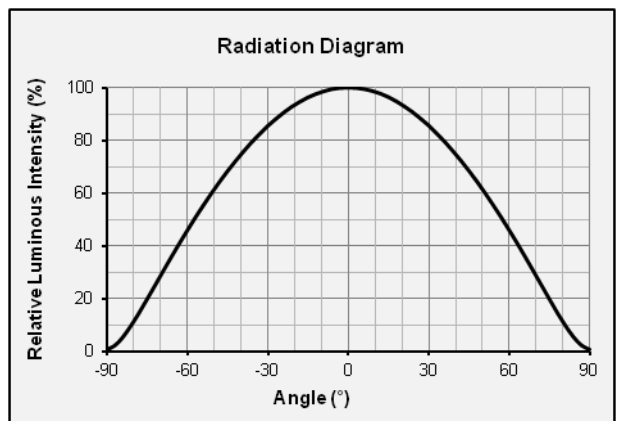

g) LC033B Characteristics

$T_c = 25\text{ }^\circ\text{C}$

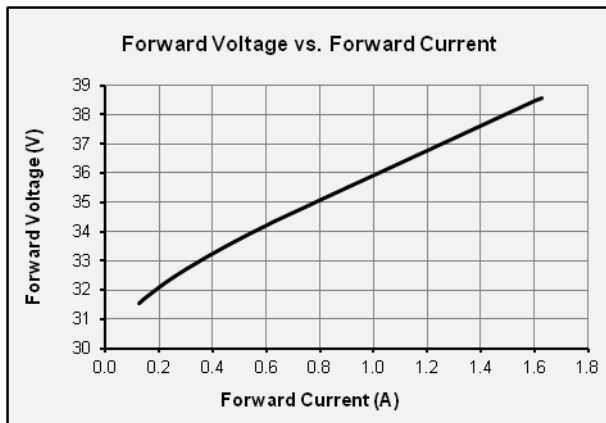
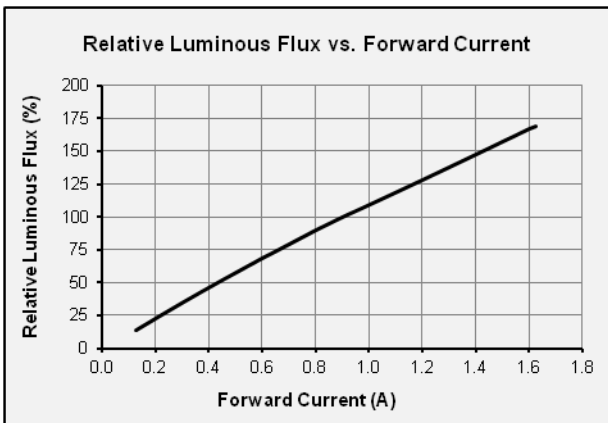

$I_f = 900\text{mA}$

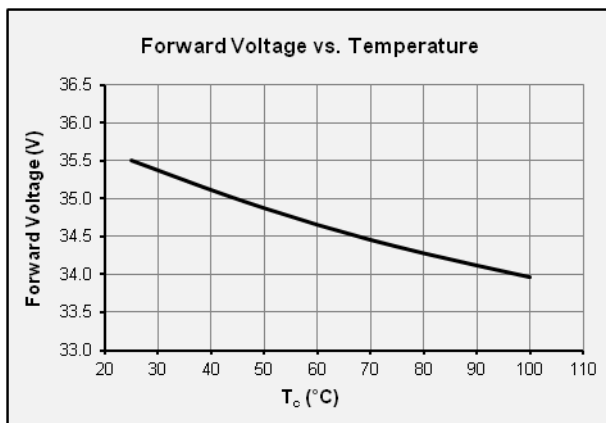
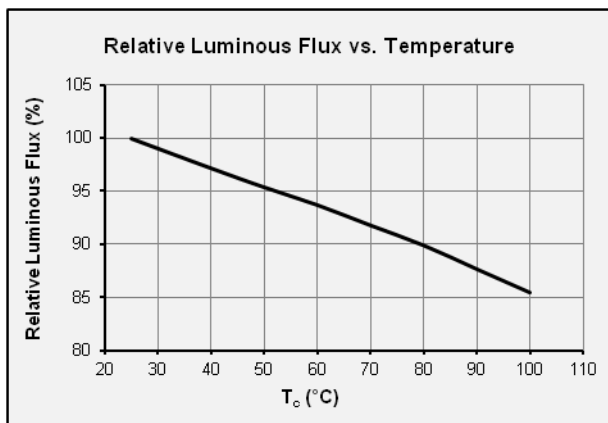

$T_c = 25\text{ }^\circ\text{C}$

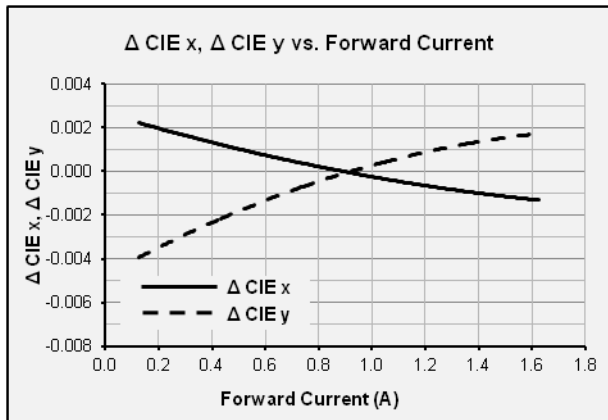

$I_f = 900\text{mA}$

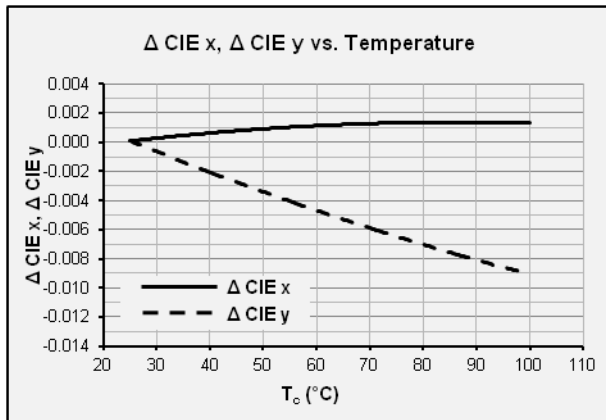

Derating Curve

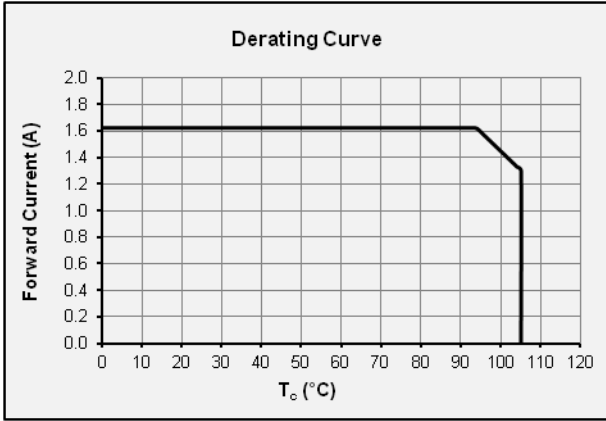

Beam Angle

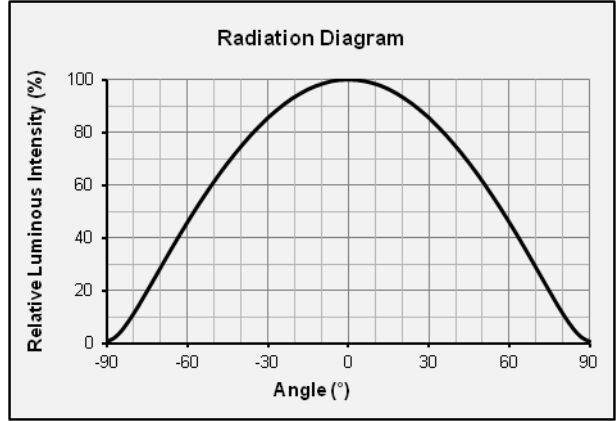

h) LC040B Characteristics

$T_c = 25\text{ }^\circ\text{C}$

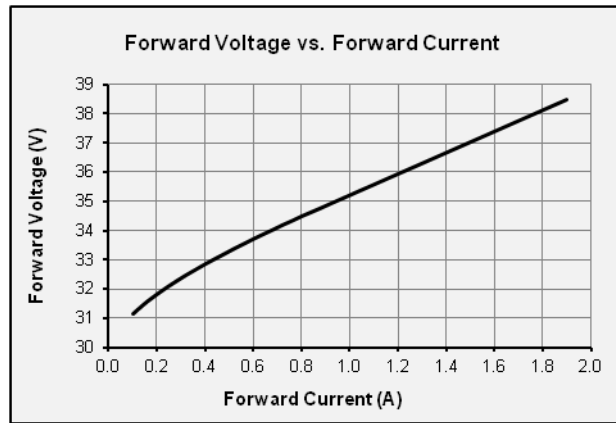
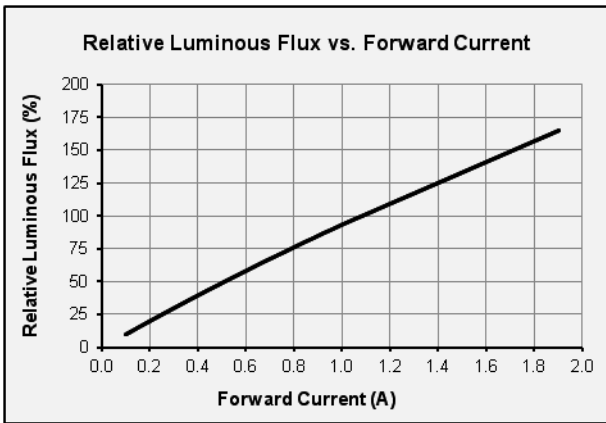

$I_f = 1,080\text{mA}$

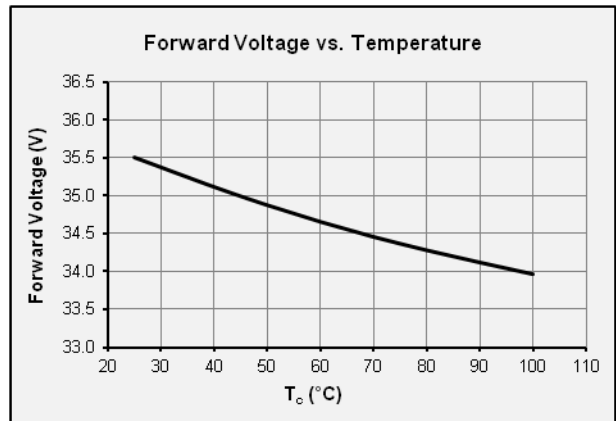
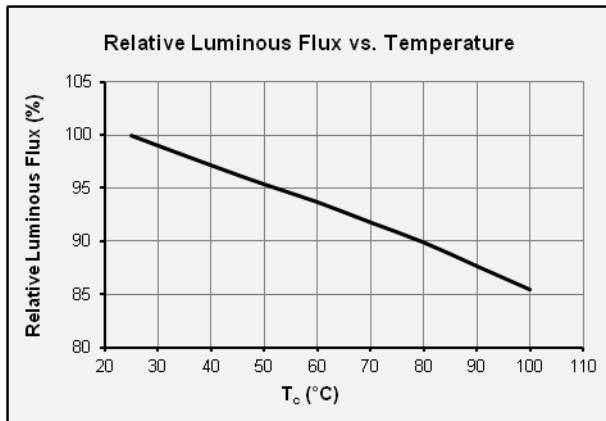

$T_c = 25\text{ }^\circ\text{C}$

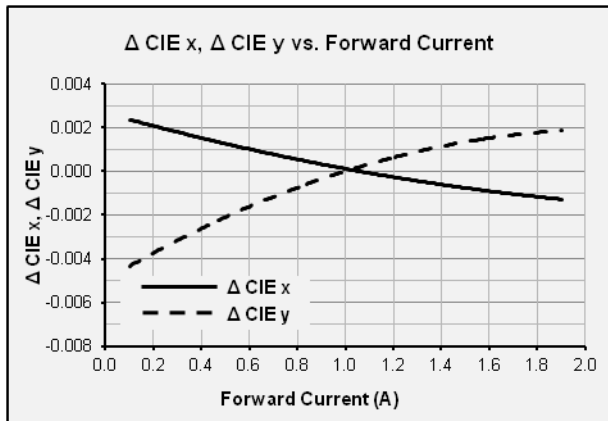

$I_f = 1,080\text{mA}$

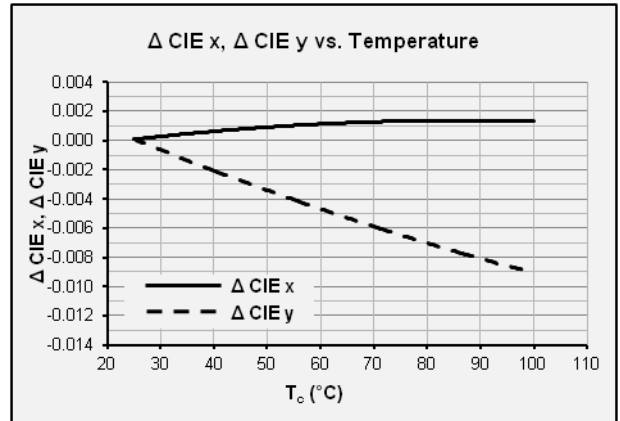

Derating Curve

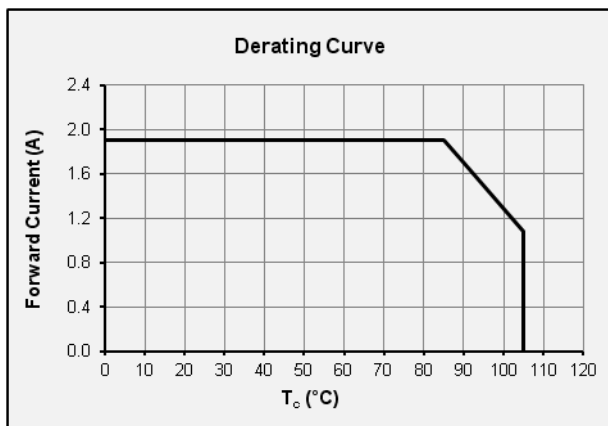

Beam Angle

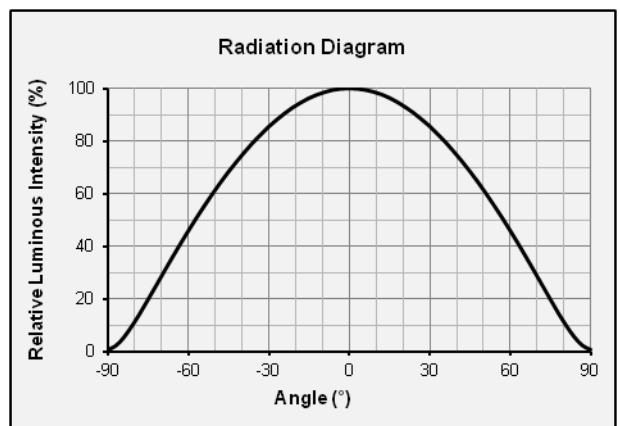

4. Outline Drawing & Dimension

a) LC006B / LC008B

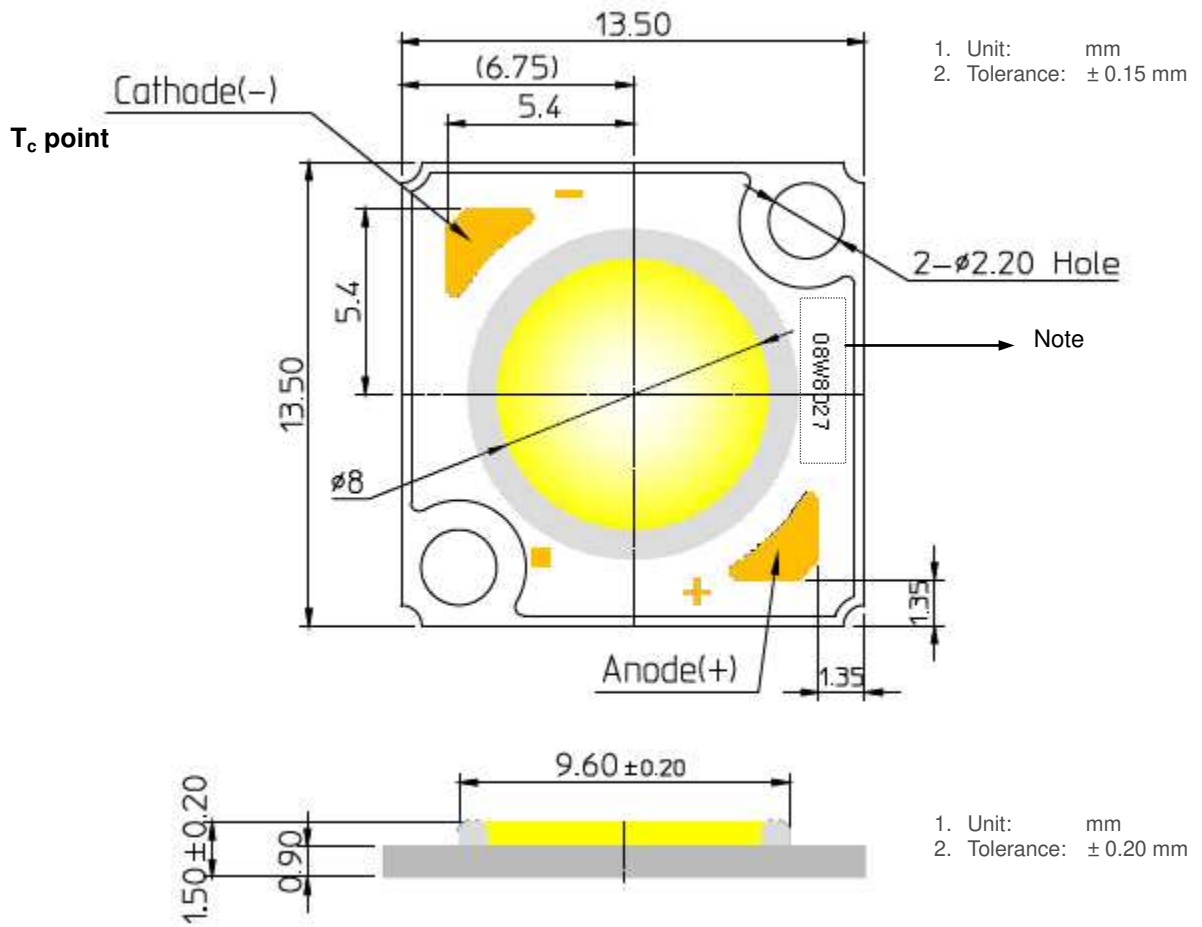

Item	Dimension	Tolerance	Unit
Length	13.50	±0.15	mm
Width	13.50	±0.15	mm
Height	1.50	±0.20	mm
Light Emitting Surface (LES) Diameter	8	±0.15	mm
Screw Hole Size	2.2	±0.15	mm

b) LC013B

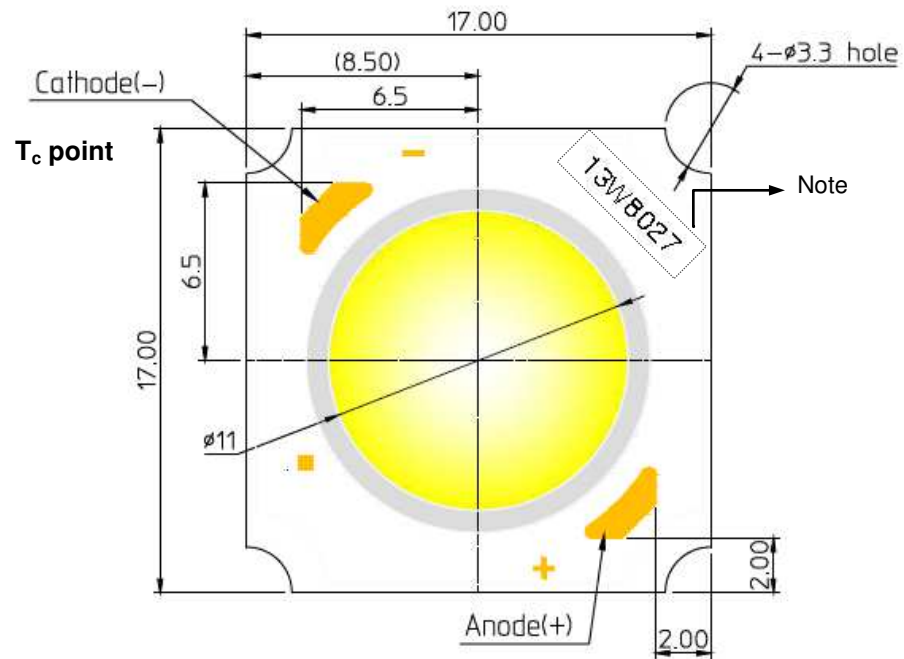

1. Unit: mm
2. Tolerance: ± 0.2 mm

Item	Dimension	Tolerance	Unit
Length	17.0	± 0.15	mm
Width	17.0	± 0.15	mm
Height	1.50	± 0.20	mm
Light Emitting Surface (LES) Diameter	11	± 0.15	mm

c) LC0019B

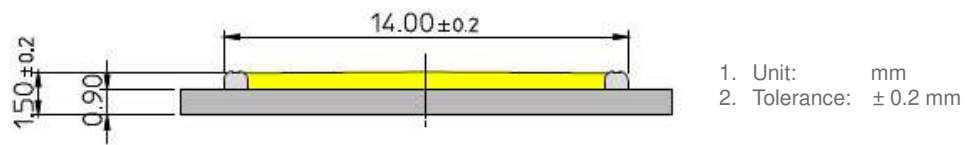
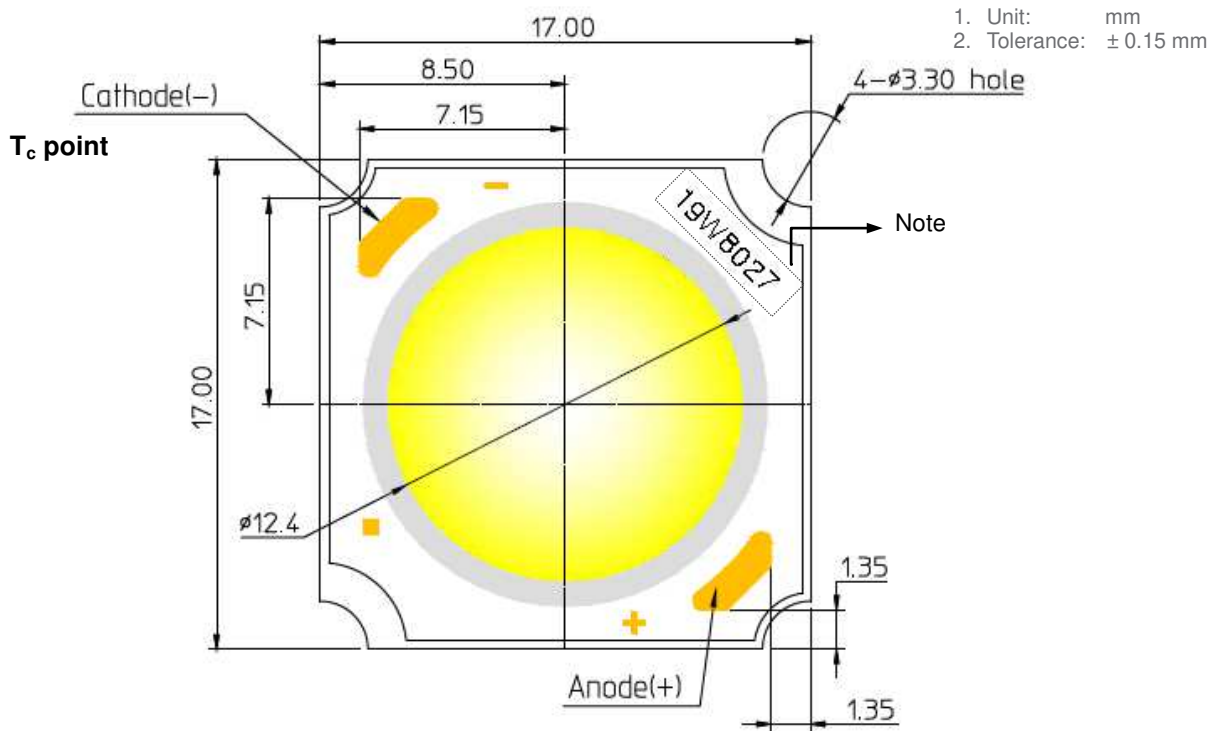

Item	Dimension	Tolerance	Unit
Length	17.0	±0.15	mm
Width	17.0	±0.15	mm
Height	1.50	±0.20	mm
Light Emitting Surface (LES) Diameter	12.4	±0.15	mm

c) LC0026B / LC033B / LC040B

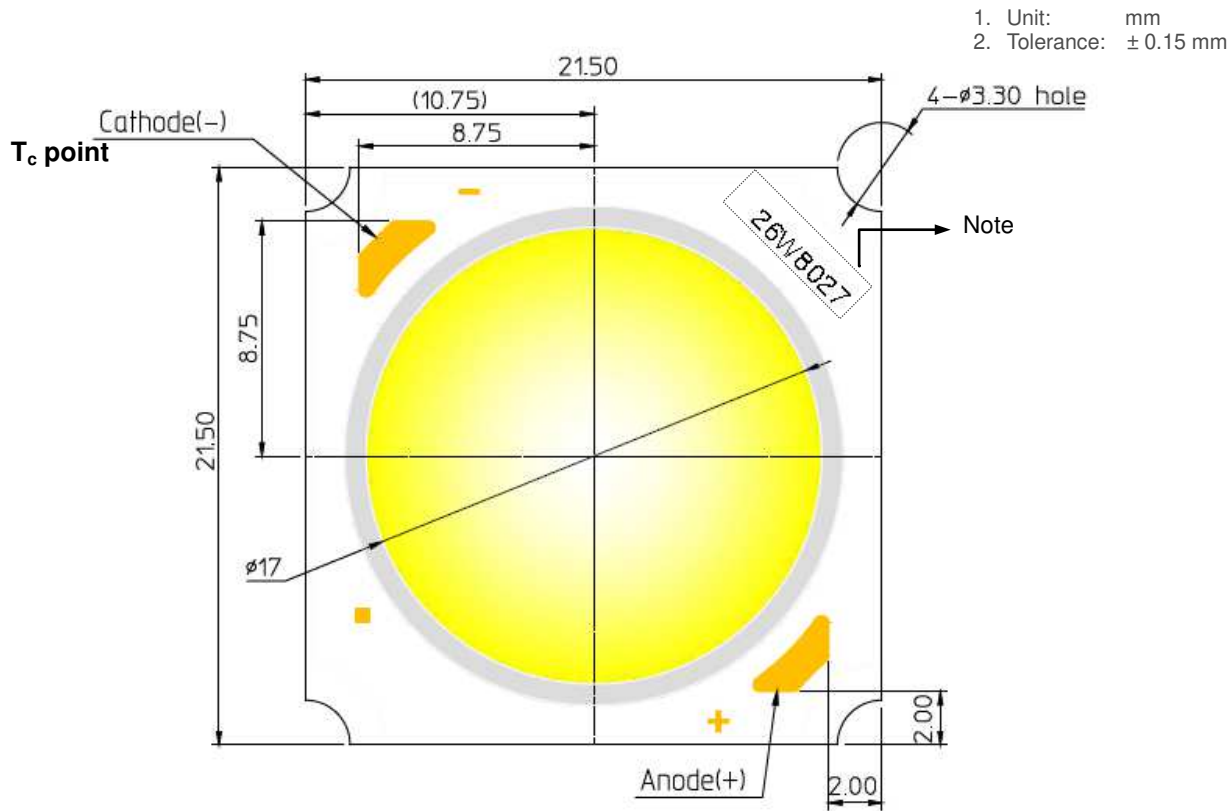

Item	Dimension	Tolerance	Unit
Length	21.50	±0.15	mm
Width	21.50	±0.15	mm
Height	1.50	±0.20	mm
Light Emitting Surface (LES) Diameter	17	±0.15	mm

Note: Denoted product information above is only an example
(26W8027 : 26W, CRI80+, 2700K)

5. Reliability Test Items & Conditions

a) Test Items

Test Item	Test Condition	Test Hour / Cycle
High Temperature Life Test	85 °C, DC Derating	1000 h
Low Temperature Life Test	-40 °C, DC $I_F = \text{max}$	1000 h
High Temperature Storage	100 °C	1000 h
Temperature Humidity Storage	60°C, 90% RH	1000h
Low Temperature Storage	-40 °C	1000 h
Thermal Cycle	-45 °C / 15 min ↔ 125 °C / 15 min temperature change in 5 min	200 cycles
ESD (HBM)	R ₁ : 10 MΩ R ₂ : 1.5 kΩ C: 100 pF V: ±2 kV	5 times
ESD (MM)	R ₁ : 10 MΩ R ₂ : 0 kΩ C: 200 pF V: ±0.5 kV	5 times
Vibration Test	20 ~ 80 Hz (displacement: 0.06 inch, max. 20 g) 80 ~ 2 kHz (max. 20 g) min. frequency ↔ max. frequency 4 min transfer	4 times
Mechanical Shock Test	1500 g, 0.5 ms each of the 6 surfaces (3 axis x 2 sides)	5 times

b) Criteria for Judging the Damage

Item	Symbol	Test Condition ($T_c = 25\text{ °C}$)	Limit	
			Min.	Max.
Forward Voltage	V_F	Typ. Current	L.S.L. * 0.9	U.S.L. * 1.1
Luminous Flux	Φ_v	Typ. Current	L.S.L * 0.7	U.S.L * 1.3

6. Label Structure

a) Label Structure

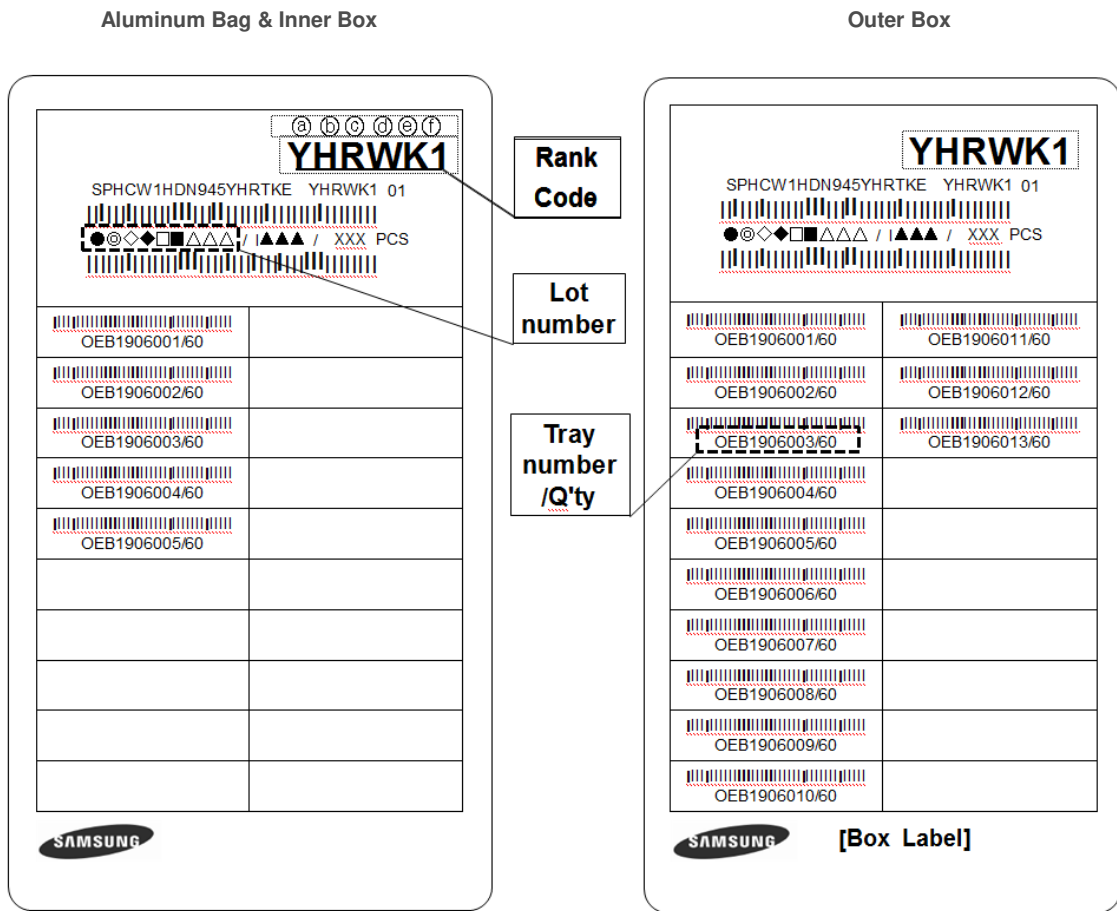

Note: Denoted rank code and product code above is only an example (see description on page 5)

Rank Code:

ⒶⒷ: Forward Voltage rank (refer to page 6-7)

ⒸⒹ: Chromaticity bin (refer to page 8-9)

ⒺⒻ: Luminous Flux bin (refer to page 6-7)