



Chipsmall Limited consists of a professional team with an average of over 10 year of expertise in the distribution of electronic components. Based in Hongkong, we have already established firm and mutual-benefit business relationships with customers from,Europe,America and south Asia,supplying obsolete and hard-to-find components to meet their specific needs.

With the principle of “Quality Parts,Customers Priority,Honest Operation,and Considerate Service”,our business mainly focus on the distribution of electronic components. Line cards we deal with include Microchip,ALPS,ROHM,Xilinx,Pulse,ON,Everlight and Freescale. Main products comprise IC,Modules,Potentiometer,IC Socket,Relay,Connector.Our parts cover such applications as commercial,industrial, and automotives areas.

We are looking forward to setting up business relationship with you and hope to provide you with the best service and solution. Let us make a better world for our industry!



## Contact us

Tel: +86-755-8981 8866 Fax: +86-755-8427 6832

Email & Skype: info@chipsmall.com Web: www.chipsmall.com

Address: A1208, Overseas Decoration Building, #122 Zhenhua RD., Futian, Shenzhen, China



## “Mini” SiSonic™ Microphone Specification

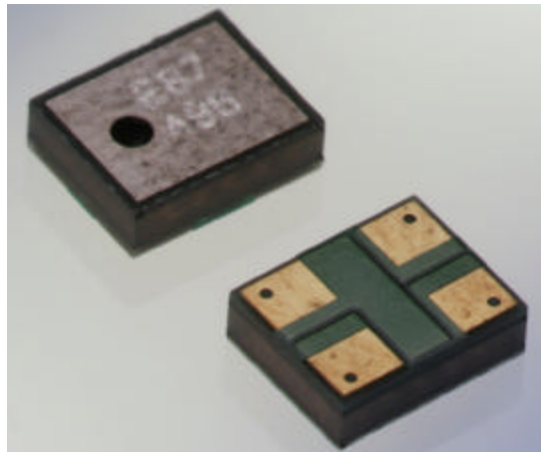

**Knowles Acoustics**  
1151 Maplewood Drive  
Itasca, IL 60143

## 1. DESCRIPTION AND APPLICATION

### 1.1 Description

“Mini” Surface Mount Silicon Microphone  
with standard RF Protection

### 1.2 Application

Hand held telecommunication devices

## 2. PART MARKING

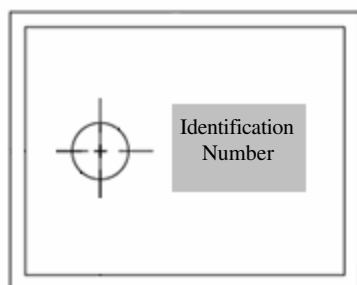

Pin 1

### Identification Number Convention

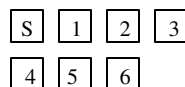

S: Manufacturing Location

“S” – Knowles Electronics Suzhou  
Suzhou, China

“No Alpha Character” – Knowles Electronics Itasca  
Itasca, IL USA

“E” – Engineering Samples

Digits 1 – 6: Job Identification Number

## 3. TEMPERATURE RANGE

3.1 Operating Temperature Range: -40°C to +100°C

3.2 Storage Temperature Range: -40°C to +100°C

## 4. ACOUSTIC & ELECTRICAL SPECIFICATIONS

	Symbol	Condition	Limits			Unit
			Min.	Nom.	Max.	
Directivity		Omni-directional				
Sensitivity	S	@ 1kHz (0dB=1V/Pa)	-46	-42	-38	dB
Output impedance	Z <sub>OUT</sub>	@ 1kHz (0dB=1V/Pa)	n/a	n/a	100	Ω
Current Consumption	I <sub>DSS</sub>	across 1.5 to 5.5 volts	0.100	n/a	0.250	mA
Signal to Noise Ratio	S/N	@ 1kHz (0dB=1V/Pa)	55	59	n/a	dB
Supply Voltage	Vs		1.5	n/a	5.5	V
Typical Input Referred Noise	ENL	A-weighted	n/a	35	n/a	dBa SPL
Sensitivity Loss across Voltage		Change in sensitivity over 5.5v to 1.5v	No Change Across Voltage Range			dB
Maximum Input Sound Level		At 100dB SPL, THD < 1% At 115dB SPL, THD = < 10%				dB

## 5. FREQUENCY RESPONSE CURVE

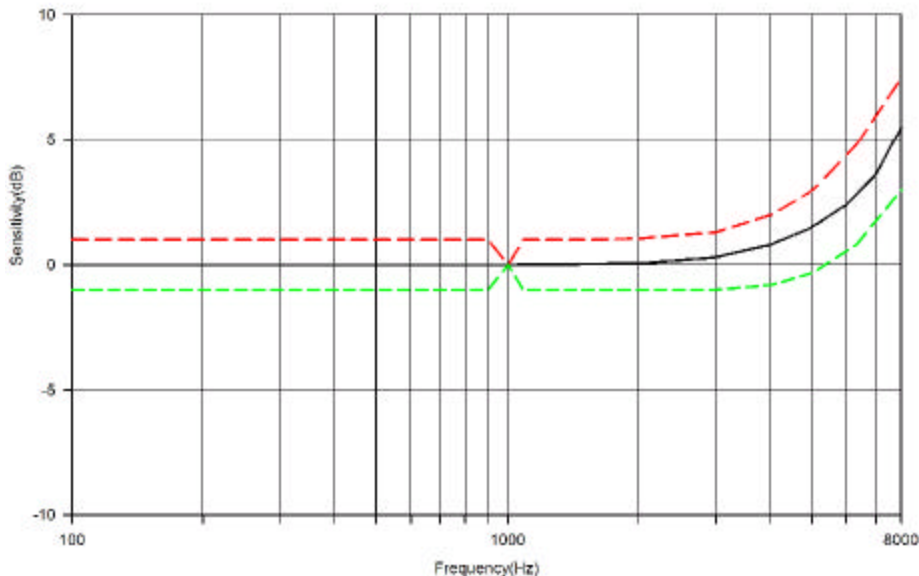



## 6. MECHANICAL SPECIFICATIONS

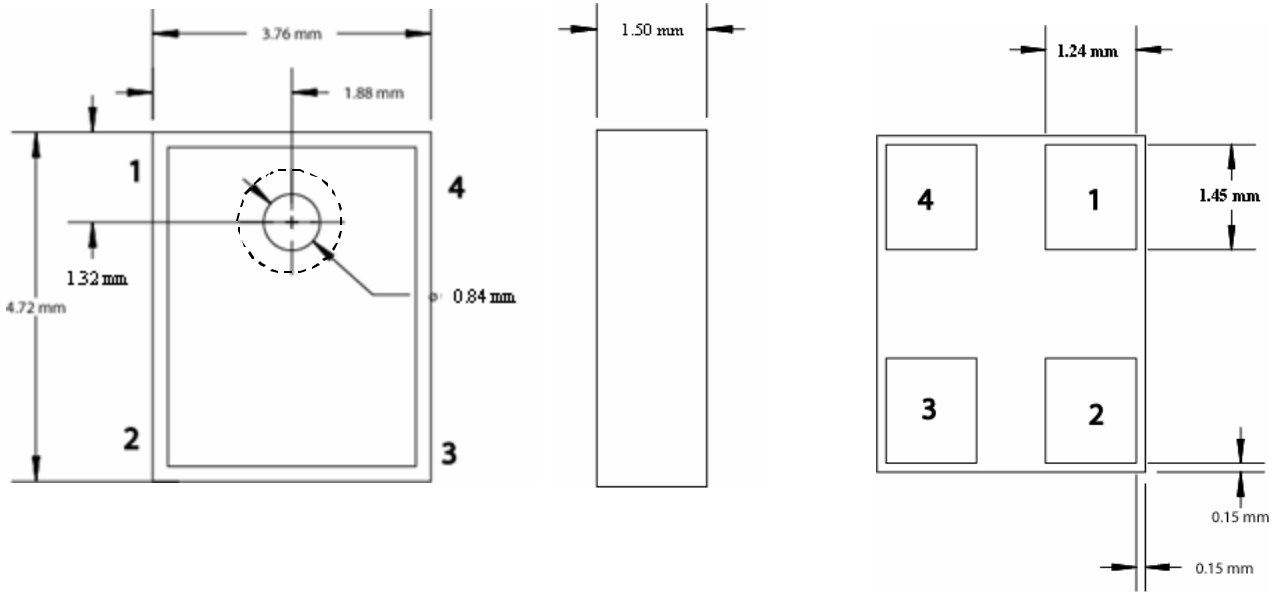

Pin Output	
Pin #	Function
1	Output
2	Ground
3	Ground
4	Power

Item	Dim.	Tol. (+/-)	Units
Height	1.50	+0.20 -0.10	mm
Length	4.72	0.10	mm
Width	3.76	0.10	mm
Port Hole	0.84	0.15	mm
Short Edge to C.L. Port	1.32	0.25	mm
Long Edge to C.L. Port	1.88	0.25	mm
Weight	0.08	grams	
Coplanarity	<0.1	mm	
Acoustic Seal I.D. (typical)	1.55	mm	

Note: (Tolerance +/-0.15mm unless otherwise specified)

## 7. RECOMMENDED CUSTOMER LAND PATTERN

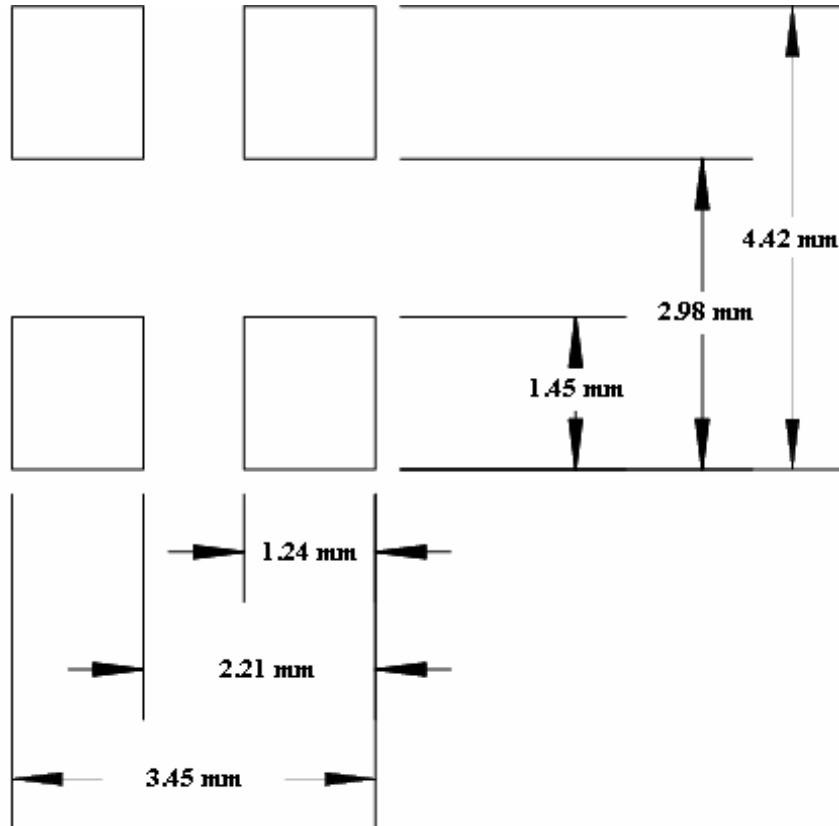

## 8. RECOMMENDED SOLDER STENCIL PATTERN

N/A

## 9. RECOMMENDED INTERFACE CIRCUIT

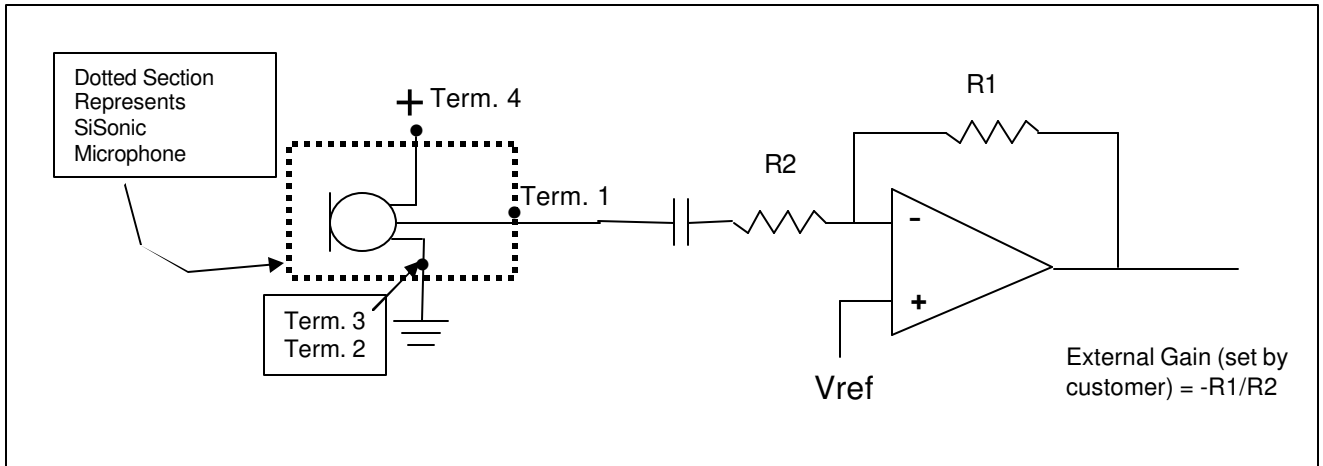

## 10. PACKAGING DETAIL

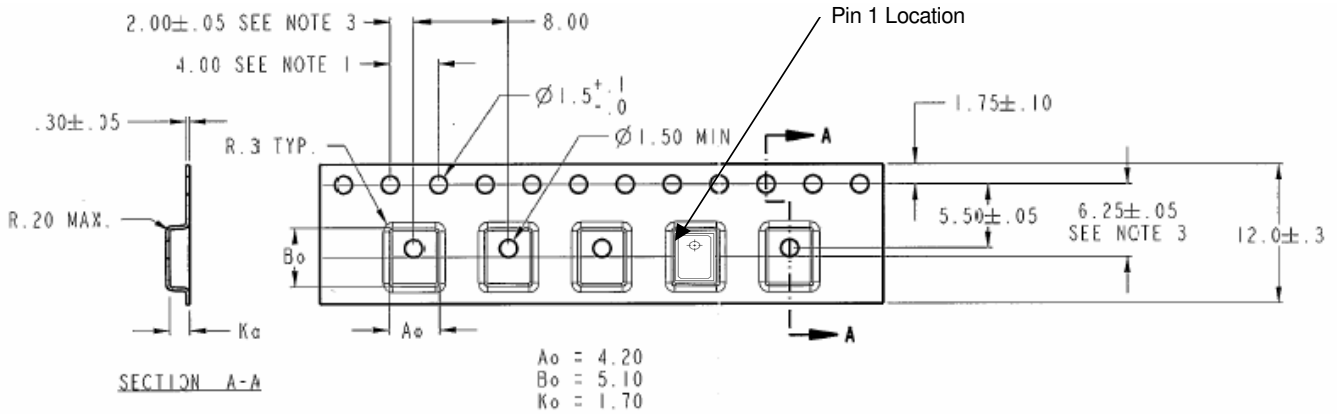

### NOTES:

1. 10 SPROCKET HOLE PITCH CUMULATIVE TOLERANCE ±0.2
2. CAMBER IN COMPLIANCE WITH EIA 481
3. POCKET POSITION RELATIVE TO SPROCKET HOLE MEASURED AS TRUE POSITION OF POCKET, NOT POCKET HOLE

Model Number	Suffix	Reel Diameter	Quantity per Reel
SPM0102ND3	-2	7"	1200
SPM0102ND3	-3	13"	4500

Leader Length	800mm or minimum of 100 empty pockets
Label	Label applied to external package and direct to reel. Per JEDEC.
Empty Units	No consecutive empty pockets; No more than 3 empty pockets per reel. (Does not include empty pockets for leader/follower)



## 11. SOLDER REFLOW PROFILE

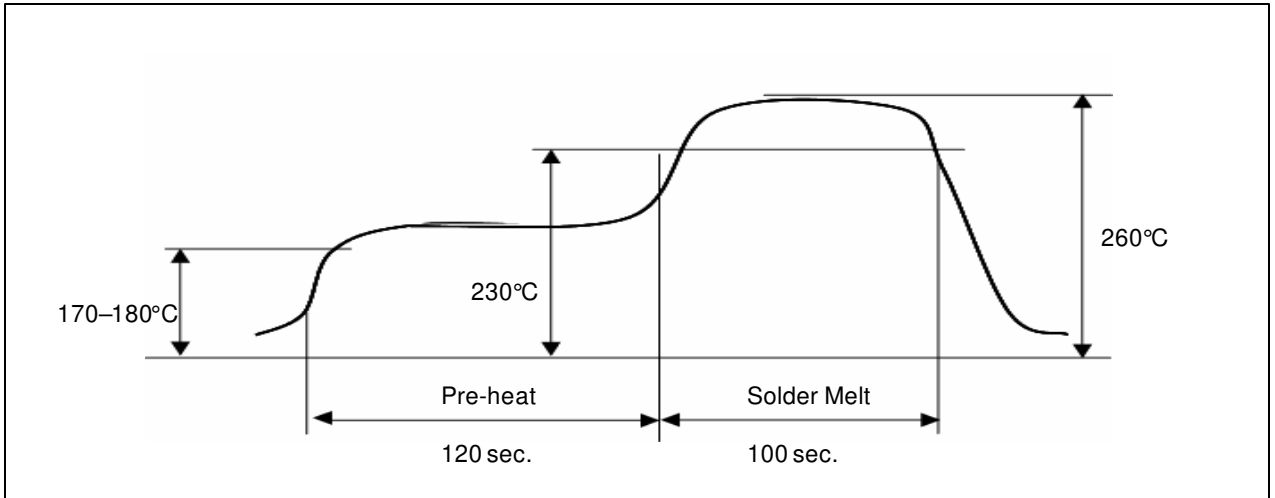

<i><b>Stage</b></i>	<i><b>Temperature Profile</b></i>	<i><b>Time (maximum)</b></i>
Pre-heat	170 ~ 180 C	120 sec.
Solder Melt	Above 230 C	100 sec.
Peak	260 C maximum	30 sec.

**Notes:**

1. Do not pull a vacuum over the port hole of the microphone. Pulling a vacuum over the port hole can damage the device.
2. Do not board wash after the reflow process. Board washing and cleaning agents can damage the device. Do not expose to ultrasonic processing or cleaning.
3. Number of Reflow = recommend no more than 3 cycles.

## 12. ADDITIONAL NOTES

- (A) Packaging (reference SiSonic\_Packaging\_Spec.pdf)
- (B) Shelf life: Twelve (12) months when devices are to be stored in factory supplied, unopened ESD moisture sensitive bag under maximum environmental conditions of 30°C, 70% R.H.
- (C) Exposure: Devices should not be exposed to high humidity, high temperature environment. MSL (moisture sensitivity level) Class 2A.
- (D) Out of bag: Maximum of 90 days out of ESD moisture sensitive bag, assuming maximum conditions of 30°C/70% R.H.

## 13. RELIABILITY SPECIFICATIONS

Note: After test conditions are performed, the sensitivity of the microphone shall not deviate more than 3dB from its initial value.

Test	Description
Thermal Shock	Microphone unit must operate when exposed to air-to-air thermal shock 100 cycles, from $-40^{\circ}\text{C}$ to $+125^{\circ}\text{C}$ . (IEC 68-2-4),
High Temperature Storage Test	Microphone unit must maintain sensitivity after storage at $+105^{\circ}\text{C}$ for 1,000 hours. (IEC 68-2-2 Test Ba)
Low Temperature Storage Test	Microphone unit must maintain sensitivity after storage at $-40^{\circ}\text{C}$ for 1,000 hours. (IEC 68-2-1 Test Aa)
High Temperature Operating Test	Microphone unit must operate within sensitivity specifications for 1,000 hours at $105^{\circ}\text{C}$ . (IEC 68-2-2 Test Ba)
Low Temperature Operating Test	Microphone unit must operate within sensitivity specifications for 1,000 hours at $-40^{\circ}\text{C}$ . (IEC 68-2-1 Test Aa)
Humidity Test	Tested under Bias at $85^{\circ}\text{C}/85\%$ R.H. for 1,000 hours. (JESD22-A101A-B)
Vibration Test	Microphone unit must operate under test condition: 4 cycles, from 20 to 2,000 Hz in each direction (x,y,z), 48 minutes, using peak acceleration of 20 G (+20%, -0%). (MIL 883E, method 2007.2, A)
Electrostatic Discharge	Tested to 8kV direct contact discharge or 15kV air discharge as specified by IEC 1000-4-2, level 3 and level 4.
Reflow	Microphone is tested to 5 passes through reflow oven, with microphone mounted upside-down under conditions of $260^{\circ}\text{C}$ for 30 seconds maximum.
Mechanical Shock	Microphone must operate after exposure to shock test of 10,000 G per IEC 68-2-27, Ea.

